

AD610 -- ShowLink® Access Point

IMPORTANT SAFETY INSTRUCTIONS









1. READ these instructions.
2. KEEP these instructions.
3. HEED all warnings.
4. FOLLOW all instructions.
5. DO NOT use this apparatus near water.
6. CLEAN ONLY with dry cloth.
7. DO NOT block any ventilation openings. Allow sufficient distances for adequate ventilation and install in accordance with the manufacturer's instructions.
8. DO NOT install near any heat sources such as open flames, radiators, heat registers, stoves, or other apparatus (including amplifiers) that produce heat. Do not place any open flame sources on the product.
9. DO NOT defeat the safety purpose of the polarized or grounding type plug. A polarized plug has two blades with one wider than the other. A grounding type plug has two blades and a third grounding prong. The wider blade or the third prong are provided for your safety. If the provided plug does not fit into your outlet, consult an electrician for replacement of the obsolete outlet.
10. PROTECT the power cord from being walked on or pinched, particularly at plugs, convenience receptacles, and the point where they exit from the apparatus.
11. ONLY USE attachments/accessories specified by the manufacturer.
12. USE only with a cart, stand, tripod, bracket, or table specified by the manufacturer, or sold with the apparatus. When a cart is used, use caution when moving the cart/apparatus combination to avoid injury from tip-over.



13. UNPLUG this apparatus during lightning storms or when unused for long periods of time.
14. REFER all servicing to qualified service personnel. Servicing is required when the apparatus has been damaged in any way, such as power supply cord or plug is damaged, liquid has been spilled or objects have fallen into the apparatus, the apparatus has been exposed to rain or moisture, does not operate normally, or has been dropped.
15. DO NOT expose the apparatus to dripping and splashing. DO NOT put objects filled with liquids, such as vases, on the apparatus.
16. The MAINS plug or an appliance coupler shall remain readily operable.
17. The airborne noise of the Apparatus does not exceed 70dB (A).
18. Apparatus with CLASS I construction shall be connected to a MAINS socket outlet with a protective earthing connection.
19. To reduce the risk of fire or electric shock, do not expose this apparatus to rain or moisture.
20. Do not attempt to modify this product. Doing so could result in personal injury and/or product failure.

21. Operate this product within its specified operating temperature range.

Explanation of Symbols

	Caution: risk of electric shock
	Caution: risk of danger (See note.)
	Direct current
	Alternating current
	On (Supply)
	Equipment protected throughout by DOUBLE INSULATION or REINFORCED INSULATION
	Stand-by
	Equipment should not be disposed of in the normal waste stream

WARNING: Voltages in this equipment are hazardous to life. No user-serviceable parts inside. Refer all servicing to qualified service personnel. The safety certifications do not apply when the operating voltage is changed from the factory setting.

WARNING: This product contains a chemical known to the State of California to cause cancer and birth defects or other reproductive harm.

AD610 ShowLink Access Point

The AD610 ShowLink access point enables real-time remote control of all ShowLink-enabled Axient™ transmitters, including both digital and analog models. The access point allows comprehensive management of transmitter parameters from the receiver or Wireless Workbench® 6 using 2.4 GHz wireless network communication. All parameter changes occur without interruption to the performer.

Multiple access points can extend the operational range or increase the number of transmitters supported on the ShowLink network. The access point also features true diversity antenna inputs.

Features

- Real-time wireless remote control of up to 24 transmitters per ShowLink access point
- New RF design and true diversity antenna scheme for improved link performance
- Easy transmitter authentication—Recognizes linked transmitters upon IR sync
- Provides coverage area approximately the same as the transmitter's range
- Automatic hand-offs between multiple access points extend operating range

- Automated channel selection—Independently scans 2.4 GHz frequency range and determines best channel for use
- Automatic frequency agility—Moves a ShowLink network to the best available 2.4 GHz channel in the event of signal degradation
- Wireless Workbench 6 software supports networked control of all device functions and provides a ShowLink plot for viewing 2.4 GHz signal levels
- Receives power via Power over Ethernet (PoE) network connection or from an external power supply
- Versatile mounting options—Fits microphone stand adapters and has built-in ¼"-20 and M6 x 1.0 threading for installation
- Backwards compatible with Axient analog transmitters and receiver

ShowLink Access Point Overview

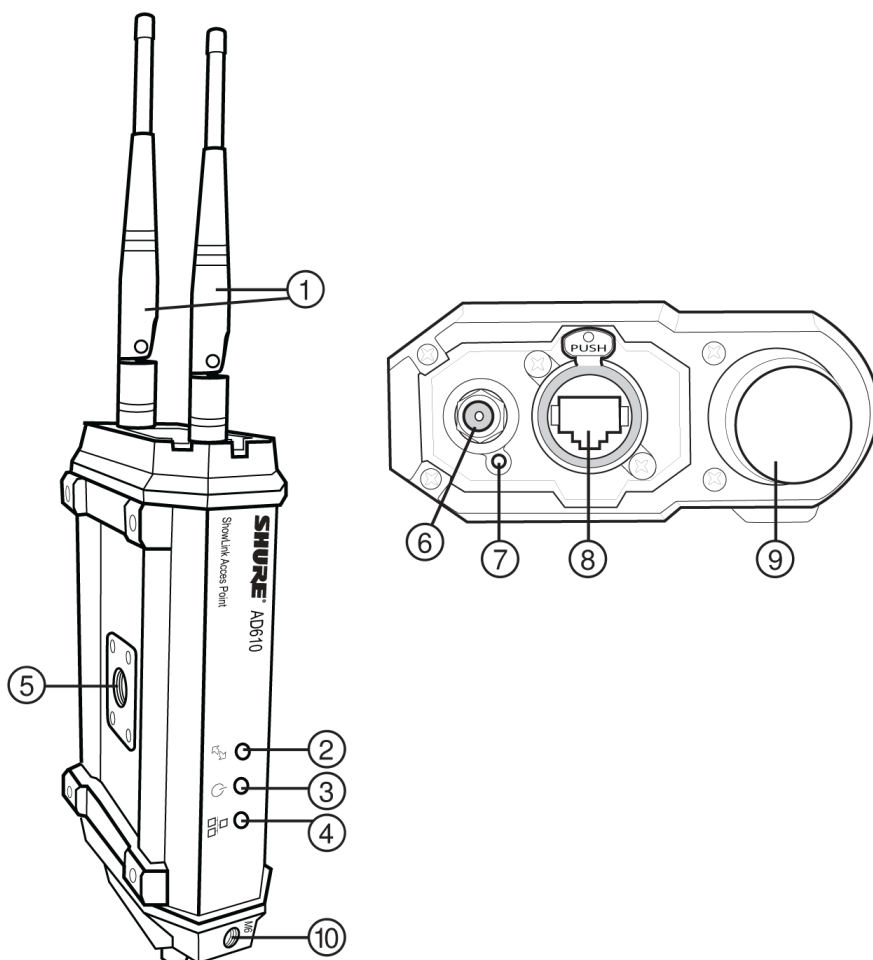

① ShowLink 2.4 GHz detachable antennas

For 2.4 GHz signals

② ShowLink Data Status LED (blue)

- ON Steady: Linked, no data transmission
- Flashing: Transmitting data. Rate of flashing indicates level of activity

③ Power Status LED (green/amber/red)

- Steady Green: Power ON, power source = PoE
- Steady Amber: Power ON, power source = external power supply
- Red Flashing: Response to remote ID flash command

④ Ethernet Status LED (green)

- ON Steady: Ethernet connected, no traffic
- ON Flashing: Ethernet connected, flashing corresponds to volume of data traffic

⑤ ¼"-20 threaded mounting point

Use to wall-mount the access point

⑥ External power supply connector

Connection point for external power supply

⑦ Reset button

Press to restore factory settings

⑧ Ethernet port

For network connection and Class 1 PoE

⑨ Scanning antenna for channel agility

Scans the 2.4 GHz spectrum for the best frequency

⑩ M6 x 1.0 threaded mounting point

Use to mount access point to safety cable

Furnished Accessories

Wireless Microphone Clip	WA371
5/8" to 3/8" Thread Adapter	31A1856
Shielded 25 foot Ethernet cable for ShowLink access point, RJ45-to-EtherCon connector	95A15104
Power Supply	PS43

Note: Model availability depends on region. See your local Shure dealer or distributor for details.

Optional Accessories

Directional 2.4 GHz patch antenna	AXT644 (available depending on regional regulations)
-----------------------------------	--

ShowLink Basics

ShowLink Channels and 2.4 GHz Spectrum

ShowLink channels that enable remote control of Axient transmitters operate in the 2.40 to 2.484 GHz portion of the RF spectrum in accordance with the IEEE 802.15.4 protocol. Devices that share the 2.4 GHz spectrum, including Wi-Fi, are manufactured to efficiently share the spectrum and cause minimal interference. Both ShowLink and Wi-Fi use "listen before talk" technology to transmit short message packets only when needed to conserve bandwidth. Available spectrum, low interference, and global availability make the 2.4 GHz spectrum an ideal choice for hosting ShowLink channels.

Within the 2.4 GHz spectrum, 16 channels are available for ShowLink communication. To ensure reliable communication, the access point contains an internal scanning radio that analyzes the 2.4 GHz spectrum hundreds of times per second. If interference is detected, the access point uses channel agility to automatically switch to a clear channel within the spectrum. All transmitters associated with the access point will continue to communicate uninterrupted on the new ShowLink channel. If ShowLink goes offline for any reason, audio transmission will not be interrupted.

Coverage Area

The coverage area of the access point is approximately the same as the transmitter's range. Use the ShowLink Test feature in the receiver menu to map the boundaries of the coverage area. Multiple access points can be used to increase the coverage area or to expand coverage to multiple rooms.

Transmitter Capacity

A single access point supports up to 24 ShowLink-enabled Axient transmitters, including both Axient and Axient Digital models. Any transmitter within range of an active access point with available capacity will be automatically controlled by that access point. When multiple access points are used to increase transmitter capacity or to increase coverage area, transmitter control is automatically divided between each access point. All changes in control between access points occur seamlessly and automatically, without requiring user intervention.

Transmitter Control

An access point with available capacity will automatically control linked transmitters that are within the coverage area. Multiple access points automatically self-manage to divide transmitter control and maintain coverage. Transitions between access point control do not affect the transmission of the audio channel.

2.4 GHz Channel Agility to Avoid Interference

When interference is present from Wi-Fi or other devices sharing the spectrum, built-in channel agility automatically switches the access point and all controlled transmitters to a clear channel. Channel agility is able to avoid interference from most devices that operate in the 2.4 GHz spectrum, such as Wi-Fi or cell phones.

ShowLink Icon

The ShowLink icon appears on the home screens of a linked transmitter and receiver to indicate that the transmitter is within range of an access point making remote control possible. If the transmitter is beyond the range of the access point, or if the receiver is offline, the icon will disappear, indicating a loss of ShowLink control.

Power

The access point is powered through Power Over Ethernet (PoE)-enabled network ports. If PoE is not available, use an external power supply.

Power Over Ethernet

The Shure Ethernet switch and Axient rack components offer network ports with Power over Ethernet (PoE). The network port powers the access point as long as the host component is powered on.

1. Insert a Cat 5 Ethernet cable into the Ethernet port located on the body of the access point.
2. The Ethernet PoE connection supplies power for the access point.

External Power Supply (Optional)

If Power over Ethernet (PoE) is not available, power the access point using an external power supply.

1. Connect the power supply to the external power supply jack.
2. Tighten the locking ring to secure the plug.
3. Plug the power supply AC line cord into an AC power source.
4. Connect a Cat 5 Ethernet cable to the access point to provide a network connection.

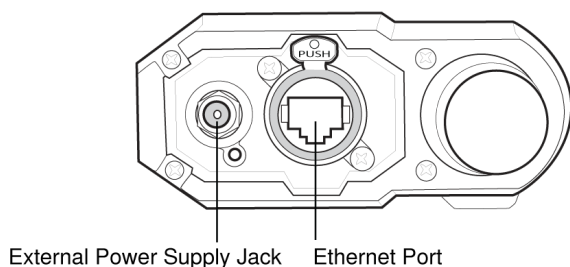

Networking

Networking the access point using a DHCP-enabled router automatically assigns an IP address, simplifying network setup. The network connection allows the access point to share data with networked components and enables wireless control of the transmitters. To manually assign an IP address to the access point, use Wireless Workbench 6.

Reset Option

Pressing the reset button located on the bottom of the housing restores the access point to the following settings:

- IP Address Mode = DHCP
- Channel Agility = Enabled
- Device ID = AD610
- Device Association Tables will be cleared

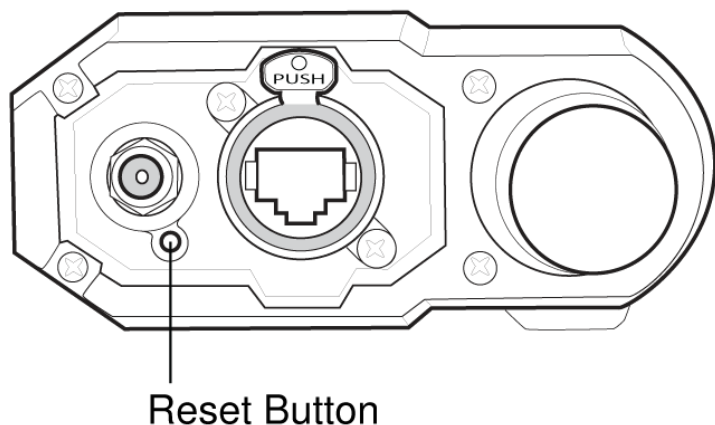

Positioning the Access Point

- Provide a clear line of sight between the access point and transmitters. Mount the access point on a microphone stand or wall to elevate above obstructions.
- Position the antennas vertically for optimal performance. The swivel joint on each antenna allows a wide range of positioning to maintain a vertical alignment.
- If possible, move access point farther from other 2.4 GHz devices.
- This product is intended to be mounted with a ¼"-20 threaded insert and installed by a qualified person with suitable mounting means as appropriate for wall surface chosen.

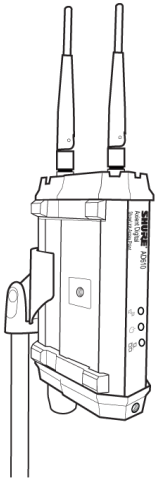

Microphone Stand Mount

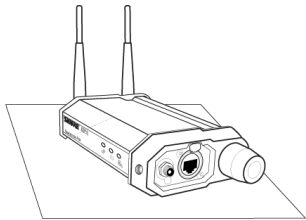

Horizontal Mount

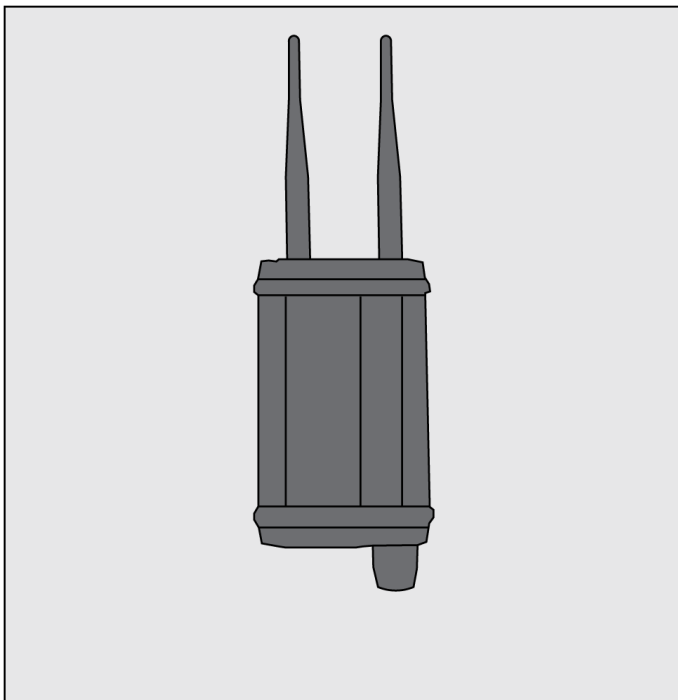

Wall Mount

Control and Configure the Access Point with Wireless Workbench 6

Wireless Workbench 6 adds the following configuration and networking options for the access point:

- Edit Device ID
- View connected transmitters
- View transmitter capacity
- Disable channel agility for troubleshooting
- Set IP Address Mode: DHCP or Manual
- Set IP Address: Edit in Manual Address Mode
- View and set subnet mask
- View MAC address

Tip: The text color of the Device ID for each transmitter in the Connected list indicates Link Quality:

- Green = Excellent
- Yellow = Good
- Red = Marginal

Hovering the cursor over the Device ID displays Link Quality ranked from 5 to 1.

Setting Power Levels

To adjust the power level, use Wireless Workbench. In locations with many competing 2.4 GHz sources, operating at a higher power level improves ShowLink performance and may extend range.

- Normal (default) = Operates at 8 dBm
- High = Operates at 18 dBm

1. Open the Properties panel for the access point in Wireless Workbench.
2. Click the Settings arrow, and select Network.
3. Choose a power level and click Apply.

Note:

- Always check regional regulations before operating in the high power setting.
 - Due to regulations, Channel 26 can only operate in the normal power setting.
-

Specifications

Antenna Type

2 Omnidirectional 2.4 GHz

Capacity

24 Axient ShowLink Transmitters (AXT or ADX Models)

Mounting Type

WA371 Mic Clip or 1/4-20 thread mount

Operating Temperature Range

-18°C (0°F) to 60°C (140°F)

Storage Temperature Range

-29°C (-20°F) to 74°C (165°F)

Dimensions

190 mm x 102 mm x 47 mm (7.48 in. x 4 in. x 1.85 in.) H x W x D, without antennas

Weight

464 g (16.3 oz.), without antennas

Housing

Extruded Aluminum

Power Requirements

Power over Ethernet (PoE) Class 1	36 to 57 V DC/V AC
External Power Supply (if PoE is unavailable)	15 V DC (600 mA), double insulated

Ingress Protection Rating

IPX3

ShowLink

Network Type

IEEE 802.15.4

Frequency Range

2.40 to 2.4835 GHz (16 channels)

RF Output Power

10 dBm ERP / 20 dBm ERP (dependent on applicable country regulations)

Working Range

Under typical conditions	150 m (500 ft)
Line of Sight, outdoors for a single system	500 m (1600 ft)

Note: Actual range depends on RF signal absorption, reflection and interference.

Antenna Connection

Connectors

2 SMA (Shell=Ground, Center=Signal)

Impedance

50 Ω

Scanning Radio

Scanner RF Sensitivity

-106 dBm, typical (integrated antenna)

Networking

Network Interface

Ethernet 10/100 Mbps

Network Addressing Capability

DHCP or Manual IP address (configurable using Wireless Workbench)

Certifications

Meets essential requirements of the following European Directives:

- WEEE Directive 2002/96/EC, as amended by 2008/34/EC
- RoHS Directive 2011/65/EU

Note: Please follow your regional recycling scheme for batteries and electronic waste

This product meets the Essential Requirements of all relevant European directives and is eligible for CE marking.

Hereby, Shure Incorporated declares that the radio equipment is in compliance with Directive 2014/53/EU. The full text of the EU declaration of conformity is available at the following internet address: <http://www.shure.com/europe/compliance>

Authorized European representative:

Shure Europe GmbH

Headquarters Europe, Middle East & Africa

Department: EMEA Approval

Jakob-Dieffenbacher-Str. 12

75031 Eppingen, Germany

Phone: +49-7262-92 49 0

Fax: +49-7262-92 49 11 4

Email: EMEAsupport@shure.de

Meets requirements of the following standards:

EN 300 328

EN 301 489 Parts 1 and 17

IEC60950

Certified under FCC Part 15.

This device complies with part 15 of the FCC Rules. Operation is subject to the following two conditions: (1) This device may not cause harmful interference, and (2) this device must accept any interference received, including interference that may cause undesired operation.

This device complies with Industry Canada licence-exempt RSS standard(s). Operation of this device is subject to the following two conditions: (1) this device may not cause interference, and (2) this device must accept any interference, including interference that may cause undesired operation of the device.

Le présent appareil est conforme aux CNR d'Industrie Canada applicables aux appareils radio exempts de licence. L'exploitation est autorisée aux deux conditions suivantes : (1) l'appareil ne doit pas produire de brouillage, et (2) l'utilisateur de l'appareil doit accepter tout brouillage radioélectrique subi, même si le brouillage est susceptible d'en compromettre le fonctionnement.

Certified by IC in Canada under RSS-247.

This radio transmitter has been approved by Industry Canada to operate with the antenna types listed below with the maximum permissible gain and required antenna impedance for each antenna type indicated. Antenna types not included in this list, having a gain greater than the maximum gain indicated for that type, are strictly prohibited for use with this device.

FCC ID: DD4AD610. **IC:** 616A-AD610.

This device operates on a no-protection no-interference basis. Should the user seek to obtain protection from other radio services operating in the same TV bands, a radio licence is required. Please consult Industry Canada's document CPC-2-1-28, Optional Licensing for Low-Power Radio Apparatus in the TV Bands, for details.

Transmitters must be installed to provide a minimum separation distance of 20 cm from all persons.

Note: EMC conformance testing is based on the use of supplied and recommended cable types. The use of other cable types may degrade EMC performance.

Important Product Information

LICENSING INFORMATION

Licensing: A ministerial license to operate this equipment may be required in certain areas. Consult your national authority for possible requirements. Changes or modifications not expressly approved by Shure Incorporated could void your authority to operate the equipment. Licensing of Shure wireless microphone equipment is the user's re-

sponsibility, and licensability depends on the user's classification and application, and on the selected frequency. Shure strongly urges the user to contact the appropriate telecommunications authority concerning proper licensing, and before choosing and ordering frequencies.

Information to the user

This equipment has been tested and found to comply with the limits for a Class B digital device, pursuant to Part 15 of the FCC Rules. These limits are designed to provide reasonable protection against harmful interference in a residential installation. This equipment generates uses and can radiate radio frequency energy and, if not installed and used in accordance with the instructions, may cause harmful interference to radio communications. However, there is no guarantee that interference will not occur in a particular installation. If this equipment does cause harmful interference to radio or television reception, which can be determined by turning the equipment off and on, the user is encouraged to try to correct the interference by one or more of the following measures:

- Reorient or relocate the receiving antenna.
- Increase the separation between the equipment and the receiver.
- Connect the equipment to an outlet on a circuit different from that to which the receiver is connected.
- Consult the dealer or an experienced radio/TV technician for help.

運用に際しての注意

この機器の使用周波数帯では、電子レンジ等の産業・科学・医療用機器のほか工場の製造ライン等で使用されている移動体識別用の構内無線局（免許を要する無線局）及び特定小電力無線局（免許を要しない無線局）並びにアマチュア無線局（免許を要する無線局）が運用されています。

1. この機器を使用する前に、近くで移動体識別用の構内無線局及び特定小電力無線局並びにアマチュア無線局が運用されていないことを確認して下さい。
2. 万一、この機器から移動体識別用の構内無線局に対して有害な電波干渉の事例が発生した場合には、速やかに使用周波数を変更するか又は電波の発射を停止した上、下記連絡先にご連絡頂き、混信回避のための処置等（例えば、パーティションの設置など）についてご相談して下さい。
3. その他、この機器から移動体識別用の特定小電力無線局あるいはアマチュア無線局に対して有害な電波干渉の事例が発生した場合など何かお困りのことが起きたときは、保証書に記載の販売代理店または購入店へお問い合わせください。代理店および販売店情報は Shure 日本語ウェブサイト <http://www.shure.co.jp> (<http://www.shure.co.jp>) でもご覧いただけます。

現品表示記号について

2.4 DS4

現品表示記号は、以下のことを表しています。この無線機器は 2.4GHz 帯の電波を使用し、変調方式は「DS」方式、想定与干渉距離は 40m です。2,400MHz ~ 2,483.5MHz の全帯域を使用し、移動体識別装置の帯域を回避することはできません。