



**SPECTRA
OWNER'S MANUAL**

For Models C / T and Ci / Ti

APB-DynaSonics, Inc.
20 West End Road
Totowa, New Jersey, 07512, U.S.A.

Tel: 973-785-1101
Fax: 973-785-1105
Web: www.apb-dynasonics.com

IMPORTANT SAFETY INSTRUCTIONS

- 1) Read These Instructions
- 2) Keep These Instructions
- 3) Heed All Warnings
- 4) Follow All Instructions
- 5) Do Not Use this Apparatus near water
- 6) **WARNING:** To reduce the risk of fire or electric shock, do not expose this apparatus to rain or moisture. Do not expose the apparatus to dripping or splashing. Do not place objects containing liquids, such as vases, on the apparatus.
- 7) For safety the AC supply must include third wire protective ground connection.
- 8) Do not block any ventilation openings at the front and rear. Install in accordance with the manufacturer's instructions.
- 9) Do not install near any heat sources such as radiators, heat registers, stoves or other apparatus (including amplifiers) that produce heat.
- 10) Do not defeat the safety purpose of the polarized or grounding-type plug. A polarized plug has two blades with one wider than the other. a grounding type plug has two blades and a third grounding prong. The wide blade or the third prong is provided for your safety. If the provided plug does not fit your outlet consult an electrician for replacement of the obsolete outlet.
- 11) Protect the power cord from being walked on or pinched particularly at plugs convenience receptacles and the point where they exit the apparatus.
- 12) Unplug this apparatus during lightning storms or when unused for long periods of time.
- 13) Refer all servicing to qualified service personnel. Servicing is required when the apparatus has been damaged in any way, such as power supply cord or plug is damaged, liquid has been spilled or objects have fallen into the apparatus, the apparatus has been exposed to rain or moisture, does not operate normally or has been dropped.

TABLE OF CONTENTS

INSTALLATION.....	6
OPERATION WITH TWIN POWER SUPPLIES	7
POWER SUPPLY PS450 - SPECIFICATION	8
YOUR SPECTRA SERIES CONSOLE.....	9
BLOCK DIAGRAM.....	10
INPUTS	12
MONO INPUT	12
EQUALIZATION SECTION MONO INPUT (SPECTRA-C/Ci).....	13
MONO INPUT EQUALIZATION AND INSERT SECTION (SPECTRA-T/Ti)	14
MONO INPUT - AUXILIARY SEND SECTION	15
MONO INPUT BUS ASSIGNMENT AND PAN.....	16
MONO INPUT - MUTE, VCA, SOLO AND LEVEL CONTROL.....	17
MONO INPUT MODULE REAR PANEL CONNECTORS.....	18
STEREO LINE INPUT SECTION	19
STEREO LINE INPUT CHANNEL - SPLIT TRACK CONTROL	20
LINE INPUT CHANNEL - STEREO EQUALIZATION SECTION.....	20
STEREO LINE INPUT CHANNELS - AUX SEND SECTION.....	21
STEREO LINE INPUT CHANNELS - BUS ASSIGNMENT AND BALANCE	22
STEREO LINE INPUT CHANNELS - MUTE, VCA, SOLO AND LEVEL CONTROL	23
STEREO LINE INPUT CHANNELS - REAR PANEL CONNECTORS.....	24
MASTER SECTION.....	25
VCA CONTROL SECTION (x8)	25
AUX MASTER OUTPUT CONTROL (x10).....	26
AUXILIARY OUTPUT REAR PANEL CONNECTORS	27
MATRIX OUTPUT SECTION (x4).....	28
MATRIX OUTPUT REAR PANEL CONNECTORS.....	29
MASTER OUTPUT SECTION.....	30
MASTER OUTPUT REAR PANEL CONNECTORS.....	31
MONO ALTERNATE OUTPUTS (x2).....	32
STEREO RECORD (ALTERNATE) OUTPUT	32
MONITOR / HEADPHONE CONTROL.....	33
TALKBACK SYSTEM	35
ALTERNATE OUTPUT CONNECTORS.....	36
MASTER CONNECTORS (MONITOR & TB)	37
SYSTEM METERING	38
CONSOLE DIMENSIONS	39
TECHNICAL SPECIFICATIONS	40

POWER SUPPLY Model PS450



THE SYMBOLS BELOW APPEAR IN THE TEXT THAT FOLLOWS AND HAVE THE FOLLOWING MEANINGS:



TO AVOID ELECTRIC SHOCK FOLLOW THE INSTRUCTION NEXT TO THIS SYMBOL.



TO AVOID AN UNSAFE CONDITION FOLLOW THE INSTRUCTION NEXT TO THIS SYMBOL

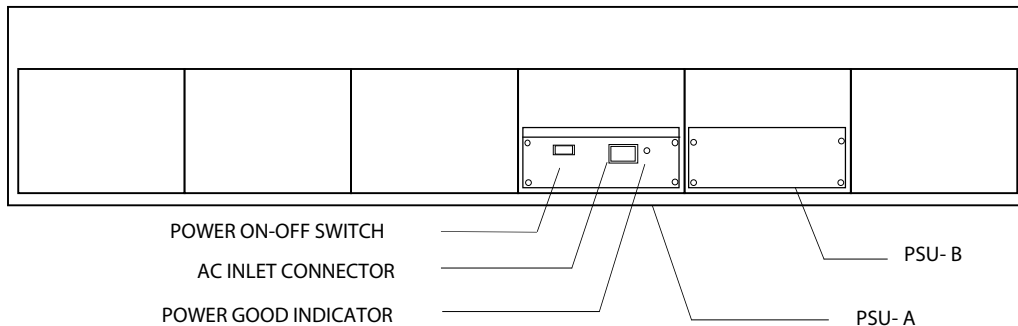

REAR VIEW OF SPECTRA CONSOLE



PSU INSTALLATION

This unit is for installation in APB DynaSonics sound mixing consoles and is intended for this purpose only. Complete consoles are shipped with power supply(s) installed.

When adding a second power supply to an existing console or when replacing an existing power supply follow these instructions:

- 1) Switch off AC power. Remove the AC power cord(s). Release the four screws holding the blanking cover plate, or the existing power supply unit. Remove the cover plate or existing power supply unit. See the diagram for fastener locations.
- 2) Insert the additional/replacement power supply unit into the opening and push it firmly to seat the connections. Replace the four fasteners.
- 3)  Use the power cord supplied to connect a source of AC power between 100V and 240V 50/60Hz.
- 4) The maximum power requirement for the largest console is approximately 500VA.
- 5)  It is a safety requirement that the AC supply connection includes third wire protective ground connection.
- 6)  Safe operation of the system requires flow of cooling air from the surroundings. Air intake is at the lower front of the console. Air exhaust is at the upper rear of the console. These openings must not be covered while the system is on. Low-noise, internal fans provide air movement.

OPERATION

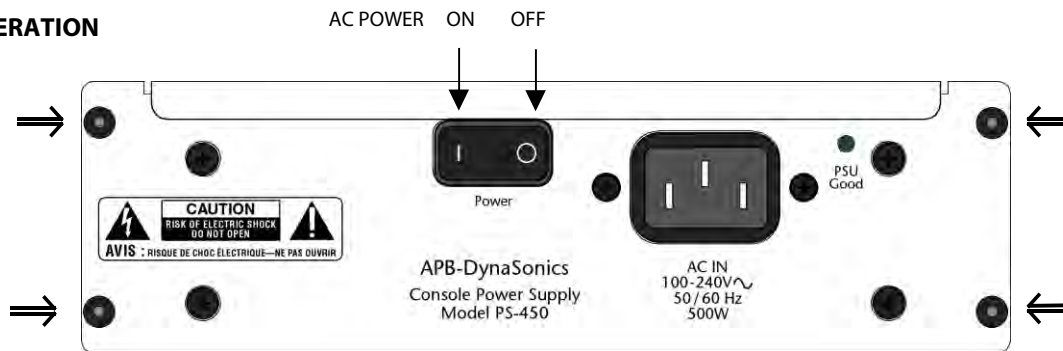

Turn on each power supply using the rocker switch on the PS panel.

Normal operation is signaled by illumination of the four green DC voltage indicators at the top center of the console and by the illumination of the adjacent blue “PSU GOOD” indicator(s) and also the green “PSU GOOD” indicator on each PS unit panel(s). The PSU Good condition is reached approx. 4 seconds after initial turn-on. This delay gives the Console’s internal circuits time to stabilize and the PSU Good signal is then used to un-mute the main outputs of the Console.

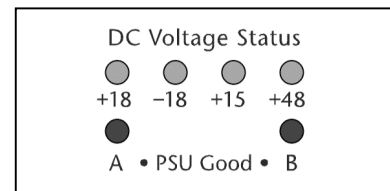

NOTE: PS450 units will only operate when electrically connected to the console circuits. When removed from the console chassis and when power is switched on, sensing circuits in the PS unit command a shutdown of the system. In this condition the PS GOOD indicator on the PS panel will not illuminate and there will be no DC outputs. If this occurs switch off, replace the unit in the console and wait 30 seconds before switching on.





Normal operation of the PS 450 requires unrestricted airflow through the unit for cooling. Fans operate at all times and circulate air within the chassis. Ambient air reaches the PS via openings at the front of the console. Ensure that the intake and exhaust openings are not obstructed.

OPERATION WITH DUAL POWER SUPPLIES

Single PS450 power units are conservatively rated to operate the 56 channel SPECTRA console continuously. For the assurance of fully redundant automatic back-up operation, the console chassis accepts a second PS450 unit. When a second PS is present and powered, both power supplies operate and the load is shared. Two independently protected sources of AC power are recommended for maximum protection against loss of power.

- 1) Connect each power supply unit to AC power using the cable included.
- 2) The power supplies must both be switched on using the panel rocker switch on both units.
- 3) Normal operation is accompanied by the green illumination of the indicators on both units. In addition two blue PS status indicators are located within view on the console light-bar.
- 4) If for any reason a supply goes into shutdown then console operation continues using the other unit, the changeover is automatic and seamless. This event would be signaled by loss of a blue PSU status indicator.

REPLACEMENT OF POWER SUPPLY UNITS

- 1)  Disconnect the AC power cord.
- 2) Remove four screws that secure the PS unit in the console chassis marked with the symbol  in the diagram. Pull on the power supply handle and the complete unit will slide out of the console chassis.
- 3) Slide the replacement unit into the console. Replace the four fixing screws.
- 4) Reconnect the AC power cord.
- 5) Switch on the power supply using the rocker switch on the panel.
- 6) Green illumination of the power supply panel indicator(s) and illumination of blue "PSU GOOD" indicators on the upper console control surface signal normal operation.
- 7) Note that the power supply units will not operate outside of the console. Automatic circuits prevent operation if the unit is switched on while out of the console.

SERVICING



CAUTION RISK OF ELECTRIC SHOCK. DO NOT OPEN THE POWER SUPPLY.

There are no user serviceable parts inside the PS unit enclosure.
Units contain hazardous AC and DC voltages.



Return defective units to APB-DynaSonics or authorized agent for servicing.

The unit will not operate outside a console. Automatic circuits prevent operation when disconnected from the console. If this occurs: switch off, replace the unit in the console and wait 30 seconds before switching back on.

POWER SUPPLY PS450 - SPECIFICATION

- High efficiency switch-mode power supply
- Zinc-plated steel enclosure with ventilation by internal fans
- PS units plug into the APB SPECTRA sound console chassis.
- IEC 60320 C13 AC inlet connection
- Universal AC input voltage and frequency 100-240V 50/60Hz
- Power Factor corrected AC input

Multiple regulated DC outputs:

+/- 18V DC @ 10A	audio system
+15V DC @ 4.5A	fans, lights, control system
+48V DC @ 0.5A	input phantom power

Multiple protection systems:

- AC input primary fuse, PCB mounted wire ended 20x5mm T8A
- AC input in-rush limiting by relay and thermistor
- AC input overvoltage MOV clamp
- AC input dual series RFI chokes
- DC output short circuit protection
- DC output overvoltage protection
- Automatic safety interlock prevents operation outside the console
- Automatic shut-down in the event of elevated & unsafe internal temperature

Approvals:

- USA Recognized power supply with ETL marking and listing
- USA and Canada UL60065 7th Edition Electrical Safety
- Europe EN60065 7th Edition Electrical Safety
- Europe EN55103-1 Emissions (Pending)
- USA FCC Part 15 Emissions (Pending)

Principal Of Operation

Power is drawn from the AC line and rectified. A switching device maintains the voltage on the internal DC reservoir capacitor within a controlled range. The main transformer operates at approximately 100kHz and steps down the primary power from about 400VDC to the low voltages required for the four regulated outputs. The high frequency low voltage AC is rectified to generate the DC output voltages required. The +/- 18V DC supplies for the audio system are coupled so that the voltage of the negative supply is a precise mirror of the positive voltage. The 48V DC supply is further processed using a three-terminal regulator to improve noise and regulation qualities. All DC outputs are short-circuit protected, the +/-18V supplies are controlled as a pair.

YOUR SPECTRA SERIES CONSOLE

Congratulations on your purchase of one of the finest live performance professional audio consoles manufactured in the United States.

Please take a moment to review this manual. It will insure a better understanding of the operation of this console and may open up new possibilities into how you use this product.

In addition to the hard copy of this manual, it will appear within our web site www.apb-dynasonics.com with the latest updates as well as new supplemental information. We suggest that you occasionally check our web site for additional information about your console as well as for new product releases and news from APB-DynaSonics.

Should you have any questions or comments about this APB-DynaSonics product, please do not hesitate to contact us at:

Tel: 973-785-1101

Fax: 973-785-1105

e-mail: info@apb-dynasonics.com

Manual Scope

This manual is not intended to teach you how to mix or how to set up a complete sound system. Should you be looking for such information, May we suggest that you do a Web Search for "Pro Audio Books" on the Internet, or attend one of the many fine Recording Schools that may be available to you. Many of these schools offer courses in Live Performance associated subjects as well as basic mixing techniques.

One of the BEST (and our favorite) sources of teaching the technical aspect of system design and operation is through the Syn-Aud-Con organization:

Synergetic Audio Concepts, Inc.,
8780 Rufing Road
Greenville, IN, 47124 – USA
800-796-2831
Fax : 812-923-3610
For calls outside of the US: 812.923.0174

Email: bbrown@synaudcon.com

www.synaudcon.com

Spectra Block Diagram

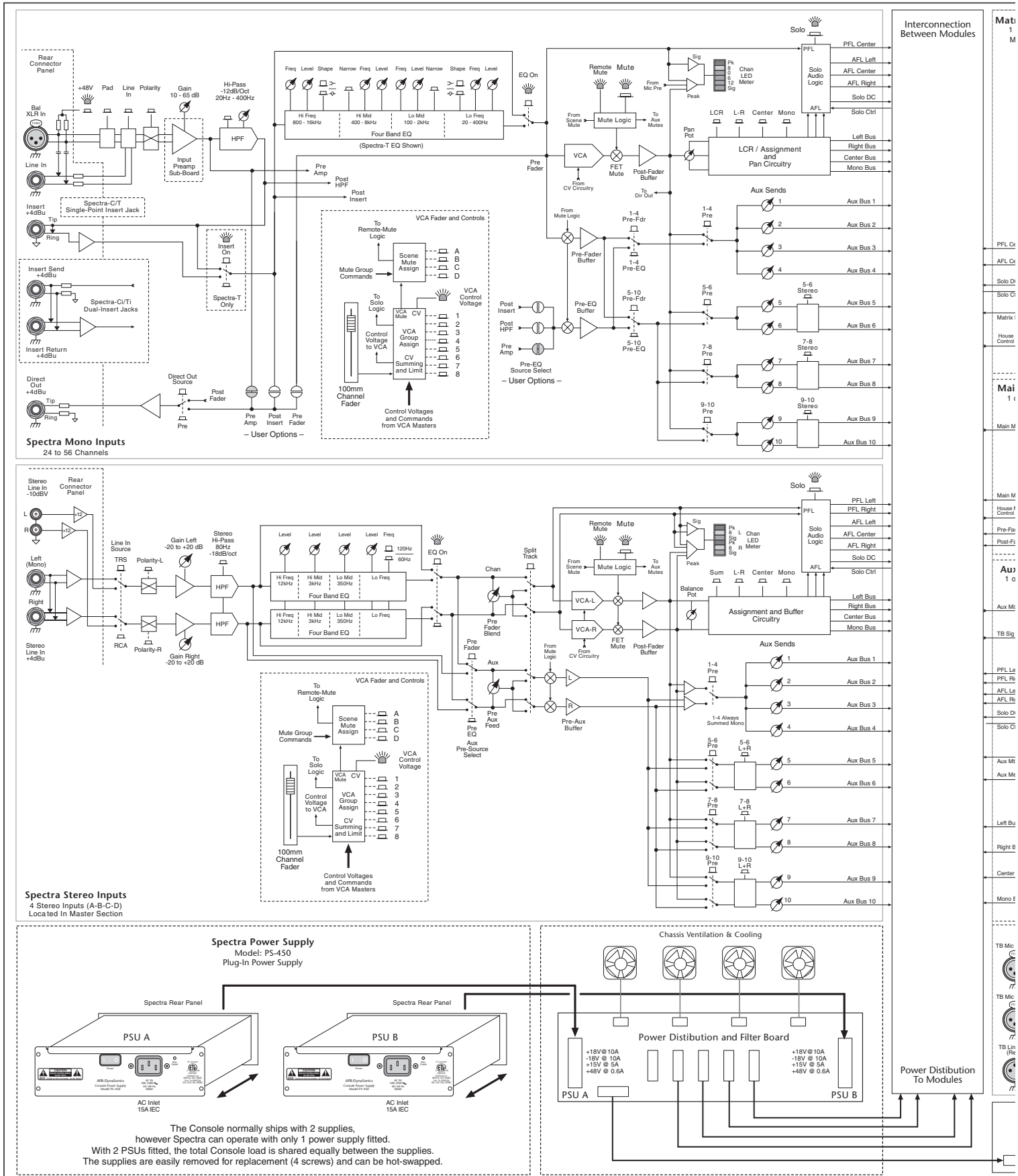

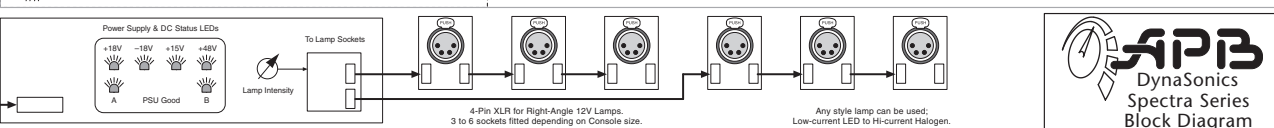
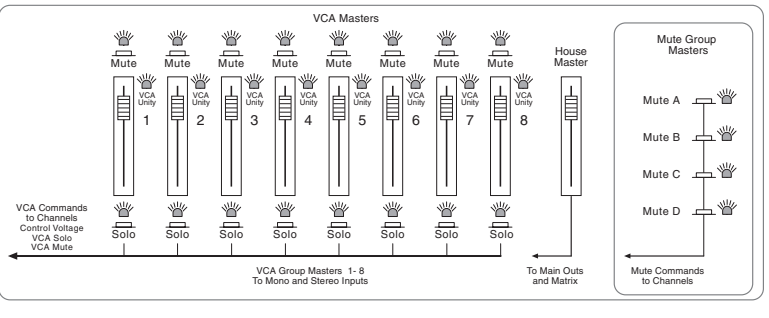
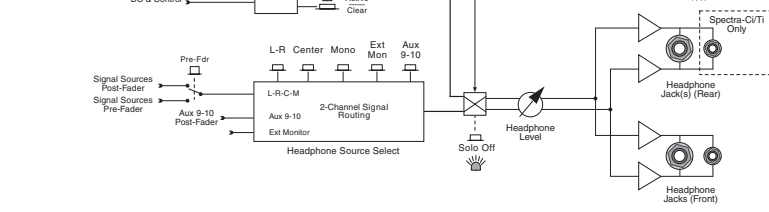
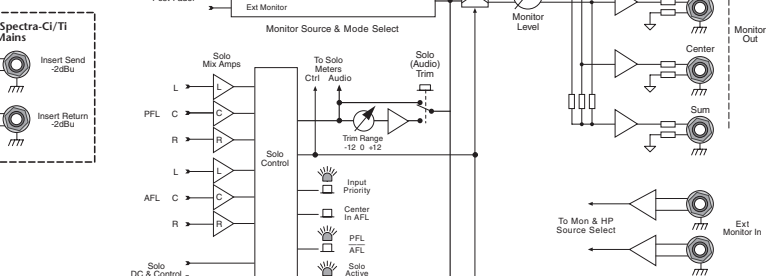
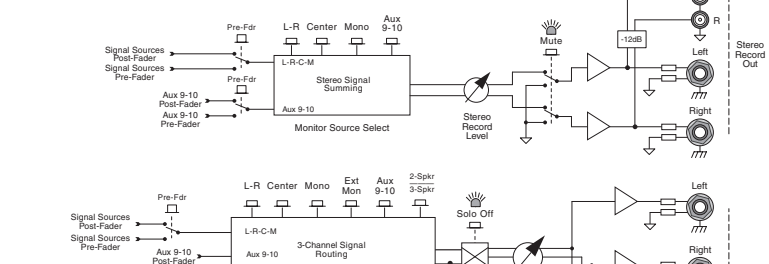
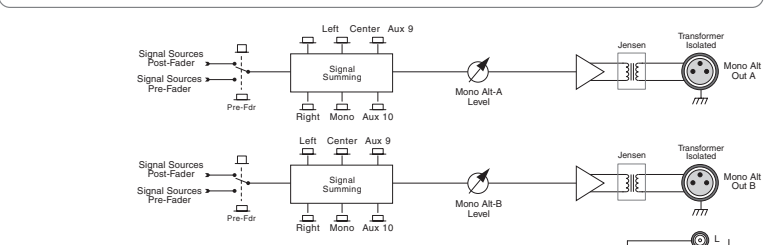
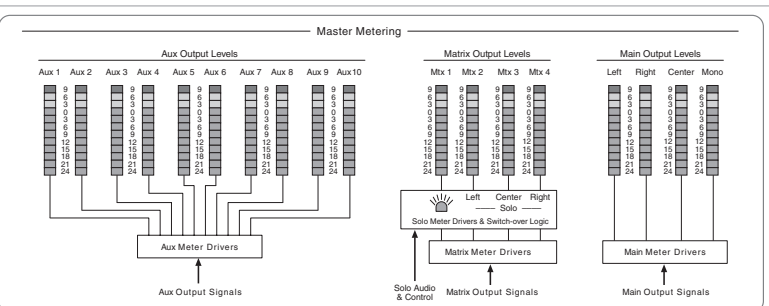
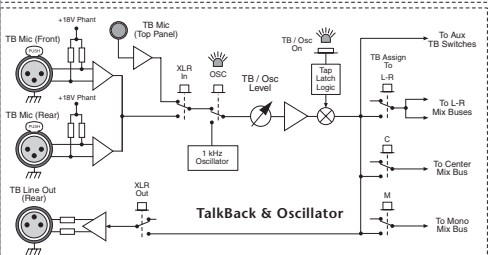
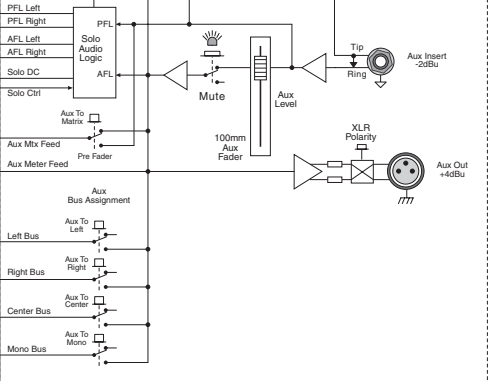
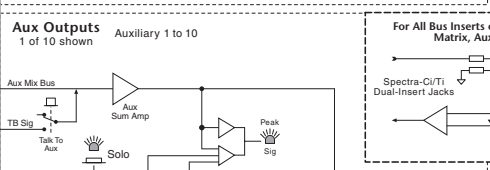
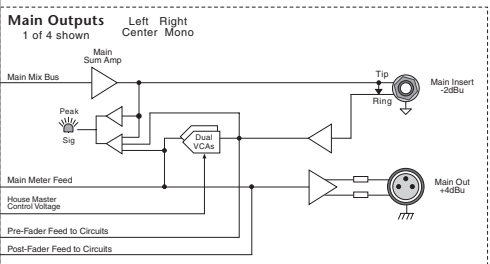
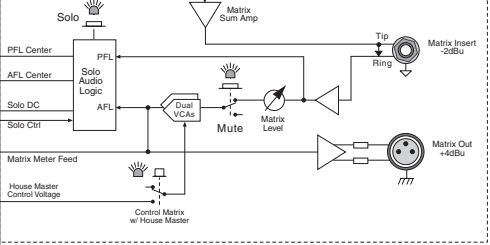
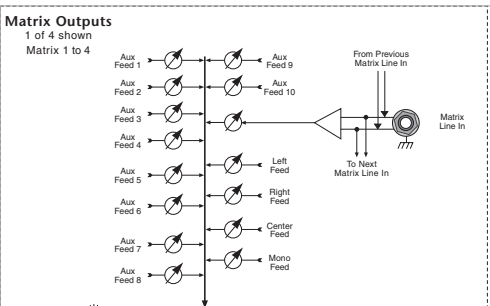
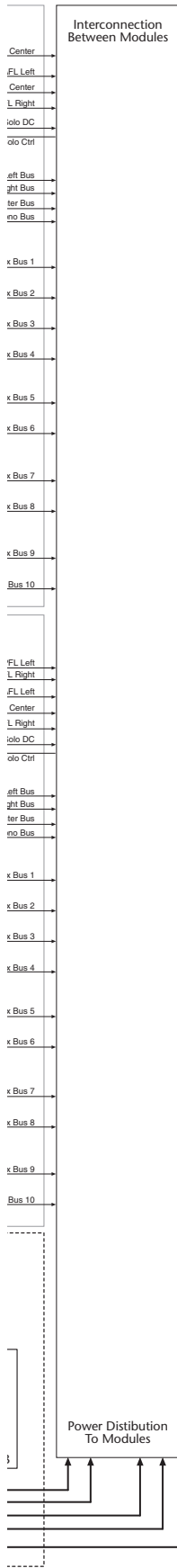

INPUTS

The following pages describe the input controls and connections of the Spectra consoles. When a section specifically applies to the C/Ci or T/Ti versions of the console, it is indicated as such in the Heading.

MONO INPUT

Line Switch

Selects between the channel XLR connector (Up) or the TRS Line Jack (Down). On the rear panel, the TRS jack's normal contacts are fed from the XLR jack; this allows a line-level signal on an XLR plug to be patched into the channel without the use of adapters. If a plug is inserted in both the XLR and 1/4" connector, this switch selects between the XLR signal and the TRS signal.

+48-Volt Phantom Power Switch with LED

When depressed, provides +48-Volt phantom power to the XLR connector. Phantom power is required for operation of many condenser microphones. See your microphone instructions to see if phantom power is required or is to be defeated (some - though few - microphones require phantom power NOT be activated or they may be damaged). A Red LED illuminates when this switch is activated.

Pad Switch

When depressed, inserts a 26dB pad into the XLR-input signal path prior to the microphone pre-amplifier to prevent overload of excessively high input signal levels. Use this pad switch when you find that you are operating the gain control in the lower third of the control range and still showing excessive signal levels (yellow and red indications) on the channel meters.

Polarity Reverse Switch

When depressed, reverses the electrical input polarity of any microphone or line level input signal. Use of this control may alter the sound quality of an input relative to other channels when multiple microphones are picking up the same sound. In the past, many consoles labeled this function as "Phase" or used the symbol "Ø."

Input Gain Control

This control adjusts the amount of gain at the input stage and should be adjusted for the best signal performance within the console. The goal is to achieve the best signal-to-noise while amplifying input signals to workable levels, neither too high nor low. The channel's six-segment meter is used for visualization of proper (pre-fader) channel levels, while soloing the channel will give more detailed level information. Proper level is achieved when there is continuous full green illuminated when input sources are at their highest levels with rare flashes of the yellow and red LED's.

Direct Output Pre Switch

This switch selects the signal source for the Direct Output from a post-fader to a pre-fader signal source. The pre-fader source is determined by internal jumpers including: (factory default in **bold**)

- 1) Mic Pre Out
- 2) Insert Send (Post HPF)
- 3) Pre-Fader (After Insert and EQ)

High-Pass Filter On Switch with LED

When depressed, activates a variable frequency high pass filter (reducing levels of all frequencies below the set frequency). When this switch is activated, an associated green LED will illuminate.

High-Pass Filter Control

Adjust the high-pass filter corner frequency between 20Hz and 400Hz at a roll off rate of 12dB per octave. This control is used to remove unwanted signal content below the set frequency such as stage rumble. The result is usually improved signal quality of the associated input signal while decreasing the low frequency amplification demand of the audio systems amplifier and speaker combination. This type of filter is also called a Low-Cut filter.

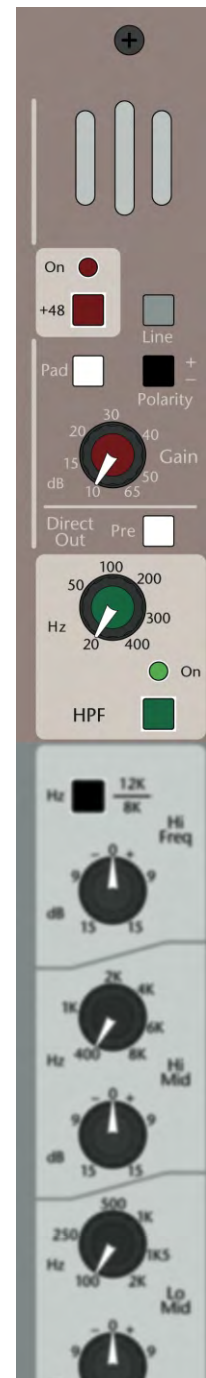

EQUALIZATION SECTION MONO INPUT (SPECTRA-C/Ci)

Hi Freq 12kHz/8kHz Selection Switch

This switch selects the corner frequency of the shelving high frequency control. The 8 kHz position will have a more dramatic effect on high frequency signals than the subtle effect of the 12 kHz frequency position. Correct frequency selection should be performed by listening for the desired effect on the input signal. If in doubt, we suggest the use of the 12 kHz position.

Hi Frequency Level Control

Adjust the high frequency cut/boost between +/-15dB. The center "0" position of this control has a detent to indicate that it is having no effect of the associated channel signal. Boost or cut of the high frequency level control is usually used for minor tonal adjustments.

Hi-Mid Variable Freq Select Control

This control adjusts the center frequency of the hi-mid frequency band EQ between 400Hz and 8kHz at a bandwidth of approximately one octave.

Hi-Mid Freq Level Control

Adjust the high-mid band cut/boost between +/-15dB. The center "0" position of this control has a detent to indicate it is having no effect of this frequency band. The high-mid frequency controls are used for minor tonal adjustment or repair of a specific band of frequencies.

Low-Mid Freq Control

This control adjusts the center frequency of the low-mid frequency band between 100Hz and 2 kHz at a bandwidth of approximately one octave.

Low-Mid Freq Level Control

Adjust the low-mid frequency cut/boost between +/-15dB. The center "0" position of this control has a detent to indicate it is having no effect of this frequency band. The low-mid frequency controls are used for minor tonal adjustment or repair of a specific band of frequencies.

Low Freq Level Control

Adjust the low frequency cut/boost between +/-15dB. The center "0" position of this control has a detent to indicate that it is having no effect of the associated channel signal. Boost or cut of the low frequency level control is usually used for minor tonal adjustments.

Low Freq 120Hz/60Hz Selection Switch

This switch selects the corner frequency of the shelving low frequency control. The 120Hz position will have a more dramatic effect on low frequency signals than the effect of the 60 Hz frequency position. Correct frequency selection should be performed by listening for the desired effect on the input signal. If in doubt, we suggest the use of the 120 Hz position for boost and 60Hz position for cut.

EQ On Switch with LED

This switch places the EQ circuitry into the console signal path. EQ activation is displayed by the illumination of a blue LED next to the EQ on switch. When not in use, it is suggested that the EQ switch be kept in the OFF position for the best phase shift performance.



MONO INPUT EQUALIZATION and INSERT SECTION (SPECTRA-T/Ti)

Insert On Switch with LED

When depressed, this switch places the rear panel TRS insert connector in line with the signal path. The insert point is after the high pass filter but before the channel EQ and is independent of the EQ-ON switch. Post high-pass filter signal is always present on this connector's output. By routing the signal through this connector, the insert may be used for applications such as an effect that can be switched in/out. *NOTE: Spectra-C/Ci includes the same insert connector(s) but it is always On.*

Variable Hi Freq Select Control

This control adjusts the corner/center frequency of the high frequency band EQ between 800Hz and 16 kHz.

Hi Freq Shelving / Bell Switch

This switch allows selection between a normal shelving response of the low frequency control (tonal adjustments) and bell shaped curve. When in bell mode, the bandwidth of the band is 2/3 octave for Boost and 1/4 octave for Cut. This *asymmetrical* setting makes the EQ band highly effective in fixing tonal problems. When in the shelving position, the boost and cut control will have a more dramatic effect on signals than in the bell position.

Hi Freq Level Control

Adjust the high frequency cut/boost between +/-15dB. The center "0" position of this control has a detent to indicate that it is having no effect of the associated channel signal.

Variable Hi-Mid Freq Select Control

This control adjusts the center frequency of the hi-mid frequency band EQ between 400Hz and 8 kHz.

Hi-Mid Freq Level Control

Adjust the high-mid frequency cut/boost between +/-15dB. The center "0" position of this control has a detent to indicate it is having no effect of this frequency band.

Hi-Mid Bandwidth Switch (Normal-Narrow)

This switch changes the Hi-Mid frequency bandwidth between 1 Octave (Up-normal) and 1/3 Octave (Down-Narrow) bandwidth. The inclusion of this bandwidth switch enables this frequency band to be used as a tool in correcting input-specific audio problems in addition to its use as a tonal control.

Variable Low-Mid Freq Select Control

This control adjusts the center frequency of the low-mid frequency band between 100Hz and 2 kHz.

Low-Mid Freq Level Control

Adjust the low-mid frequency cut/boost between +/-15dB. The center "0" position of this control has a detent to indicate it is having no effect of this frequency band.

Low-Mid Bandwidth Switch (Normal-Narrow)

This switch selects the Low-Mid frequency bandwidth between 1 Octave (Up-normal) and 1/3 Octave (Down-narrow) bandwidth. The inclusion of this bandwidth switch enables this frequency band to be used as a tool in correcting input specific audio problems in addition to its use as a tonal control.

Variable Low Freq Select Control

This frequency control adjusts the corner frequency of the low frequency band EQ between 20Hz and 400Hz.

Low Freq Shelving / Bell Switch

This switch allows selection between a normal shelving response of the low frequency control (tonal adjustments) and bell shaped curve. When in bell mode, the bandwidth of the band is 2/3 octave for Boost and 1/4 octave for Cut. This *asymmetrical* setting makes the EQ band highly effective in fixing tonal problems. When in the shelving position, the boost and cut control will have a more dramatic effect on signals than in the bell position.

Low Freq Level Control

Adjust the low frequency cut/boost between +/-15dB. The center "0" position of this control has a detent to indicate that it is having no effect of the associated channel signal.

EQ On Switch with LED

This switch inserts the EQ into the signal path, which is indicated by the illumination of an LED next to the switch. When not in use, keep the EQ off for the best phase shift performance.



MONO INPUT - AUXILIARY SEND SECTION

Aux 1-4 & 5-10 Pre-Source Switches

These switches select the "Pre" signal source for Aux 1-4 and Aux 5-10 between Pre-fader and Pre-EQ. These switches are relevant only when the associated (4) Aux Pre-Source (Pre-Src) switches are depressed. The default Pre-EQ source is internally set to Post-insert. A qualified technician can change this to a Pre-insert or Pre-high-pass filter setting.

Aux 1-4 Post-Fader/Pre-Source

This switch selects the signal source for Auxes 1-4 between Post-fader and Pre-Source (as determined above).

Aux Level Controls 1-4

Controls the mix level of the channel into Aux buses 1-4.

Aux 5-6 Post-Fader/Pre-Src

This switch selects the signal source for Aux 5-6 between Post-fader and Pre-Source.

Aux 5-6 Stereo Switch

Reconfigures the individual Aux 5 and 6 controls from two level controls to a pan control (5) and a level control (6). This enables a stereo mix to be generated from within the Aux send section for use with stereo headphones, effects, or a discrete stereo mix for recording or broadcast use.

Aux 5 Level Control

When in normal mono mode, controls the signal level feeding Aux mix bus 5. When the Aux 5-6 stereo switch is depressed, this control is now reconfigured into a pan control, which adjusts the balance of signal being fed to mix buses 5-6.

Aux 6 Level Control

When in normal mono mode, controls the signal level feeding Aux mix bus 6. When the Aux 5-6 stereo switch is engaged, this control becomes the Aux 5-6 signal level and is fed to the pan control.

Aux 7-8 Post-Fader/Pre-Src

This switch selects the signal source for Aux 7-8 between Post-fader and Pre-Source.

Aux 7-8 Stereo Switch

Reconfigures the individual Aux 7 and 8 controls from two level controls to a pan control (7) and a level control (8). This enables a stereo mix to be generated from within the Aux send section for use with stereo headphones, effects, or a discrete stereo mix for recording or broadcast use.

Aux 7 Level Control

When in normal mono mode, controls the signal level feeding Aux mix bus 7. When the Aux 7-8 stereo switch is depressed, this control becomes a pan control, which adjusts the balance of signal being fed to mix buses 7-8.

Aux 8 Level Control

When in normal mono mode, controls the signal level feeding Aux mix bus 8. When the Aux 7-8 stereo switch is engaged, this control becomes the Aux 7-8 signal level and is fed to the pan control.

Aux 9-10 Post-Fader/Pre-Src

This switch determines the signal source for Aux 9-10 between Post-fader and Pre-Source.

Aux 9-10 Stereo Switch

Reconfigures the individual Aux 9 and 10 controls from two level controls to a pan control (9) and a level control (10). This enables a stereo mix to be generated from within the Aux send section for use with stereo headphones, effects, or a discrete stereo mix for recording or broadcast use.

Aux 9 Level Control

When in normal mono mode, controls the signal level feeding Aux mix bus 9. When the Aux 9-10 stereo switch is depressed, this control changes to a pan control adjusting the signal being fed to mix buses 9-10.

Aux 10 Level Control

When in normal mono mode, controls the signal level feeding Aux mix bus 10. When the Aux 9-10 stereo switch is engaged, this control becomes the Aux 9-10 signal level and is fed to the pan control.

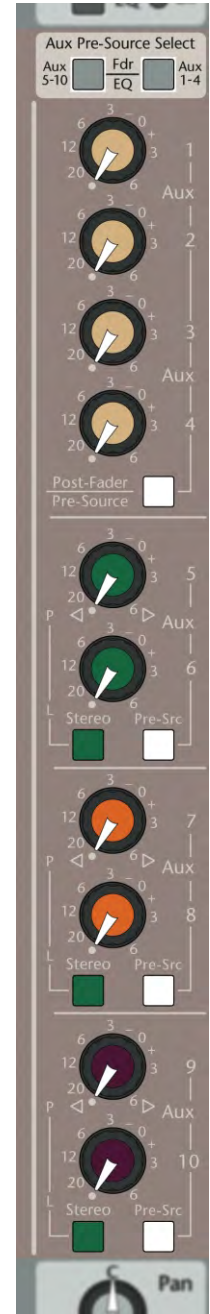

Discrete Sub Woofer Feed Using Aux Sends

Any Aux bus may be used as a mixed feed to a subwoofer system since any of the Aux sends can be assigned from the master section to any of the primary outputs including MONO, the suggested output for subwoofers. The Left-Right, Center, and Mono outputs are controlled from a single VCA fader maintaining balance between all outputs.

MONO INPUT BUS ASSIGNMENT AND PAN

L-R Assignment Switch

Assigns the post-fader channel signal to the Left-Right mix bus through the Left-Right Pan Control. In Stereo or Dual Mono sound systems, this is the most likely used primary output assignment on the console (In Stereo operation, signal is panned through the pan pot system to generate a panoramic image – In Dual Mono operation, an identical signal (pan control positioned to center to send an equal and identical signal to the left and right mix bus system) is fed providing system redundancy. In systems that include a center (vocal) cluster, the left and right channels are usually used for stereophonic music reproduction. The Left/Right outputs are also used for music reproduction when Center and Mono mix buses are used for A-B vocal mixing. In theatrical applications where identical speakers covering identical physical areas are used for "A" vocal mix and "B" vocal mix, eliminating any electrical comb filter effect between the two mics.

Center Assignment Switch

Assigns the post-fader channel signal to the Center mix bus. In mono sound systems, this bus can be used as the primary output (leaving the L-R output available for stereo recording). It is usually used in LCR installations to feed a discrete signal to the center speaker cluster (when not using the LCR assignment system). It may also find use as a general purpose post fader output for use as an additional aux or matrix send or as mix A of an A-B vocal mix.

Mono Assignment Switch

Assigns the post fader input signal to the Mono mix bus. It is used as a general purpose post fader output for an additional primary console output. It may also be used as mix B of an A-B vocal mix.

LCR Assignment Switch

This switch overrides the Left-Right and Center assignment switches, meaning that the individual L-R and Center switch positions are no longer active. Instead, the post fader signal is fed directly to the pan control that is now re-configured to send signal to the Left-Center-Right mix buses in the desired pan location.

Pan Control (L-R or LCR)

In normal operation, this control takes the post fader signal from the L-R assignment switch and controls the proportion of signal feeding between the left and right mix buses. When at the center position, both left and right signals become equal. The Pan control never has an affect on the feed to the Mono bus, and only affects the feed to the Center bus when in LCR mode.

When in LCR mode, this control is reconfigured to feed and balance the Left - Center - Right mix buses. As an example of operation, when this control is set fully counter-clockwise, signal is sent to the left mix bus with no signal being sent to the center or right mix buses. As the control is turned clockwise, signal starts to decrease to the left mix bus but begins to increase in the center. No signal is yet being fed to the right mix bus. When the LCR pan control is positioned to center, no signal is fed to the left or right mix buses, but the full signal is now fed to the center mix bus. As the knob continues to be turned clockwise, the level begins to decrease to the center bus and increases to the right mix bus. When the control is turned fully clockwise, all signal is fed to the right mix bus while no signal is fed to the left or center mix bus. The taper of this control is tailored to industry standards.



Discrete Sub Woofer Feed Using Mono Assignment Bus

The MONO bus may be used as a fixed level discrete feed to a sub-woofer system. The Left-Right, Center, and Mono outputs are controlled from a single VCA master fader maintaining balance between all outputs including the MONO sub output when master signal levels are changed.

MONO INPUT - MUTE, VCA, SOLO and LEVEL CONTROL

Local Mute Switch - Internally Illuminated

Activation of this switch will mute the primary outputs as well as all pre and post fader auxiliary sends of the channel. When depressed, it will illuminate RED, indicating the status of this local mute only; another LED located beneath this switch indicates the status of any remote activated mutes. Activation of either mute system will not affect the channel's metering or the Solo-PFL signals, these are both located Pre-Fader/Pre-Mute. However, the channel's Solo-AFL signal is Post-Fader/Post-Mute (and Post-Assign), so if a channel is muted (or not assigned), no Solo-AFL will be available.

Remote Mute Activated Led

This LED will illuminate red when a mute command is received from any of the possible 12 remote mutes (8 VCA mutes + 4 Mute Groups).

Scene Mute Preset Switches A Thru D

When any of these switches are selected, it will cause the input channel to mute (and Remote Mute LED to illuminate) when the associated Mute Group switch within the master section is activated. Activation of a scene mute affects the channel the same way as a Local Mute.

VCA Status Indicator (CV= Control Voltage)

The VCA status LED will illuminate in varying levels of green in proportion to voltage being applied to the VCA element. This voltage is controlled by the channel fader as well as any of the 8 VCA master faders that may be assigned to the channel. This LED will turn red if the voltage being applied approaches the maximum allowable. The CV circuitry will then limit the voltage being applied to the VCA to prevent the channel fader gain from exceeding the 20dB design limit.

VCA Assignment Switches 1 through 8

When any of these switches are depressed, it allows the associated master VCA level to have parallel control of the channel VCA element. Any combination of switches may be chosen, all of which will sum together to create the final voltage being applied to the VCA element. Maximum voltage being applied to the VCA element is limited and indicated by the VCA status (CV) LED turning red (see above). These switches also act as presets for 8 additional scene mutes, but limited to the same assignment groups as the VCA. When any of the associated VCA mute switches within the master section are activated, the channel will be muted in the same manner as from the Mute Group section of the console.

Channel Level Meters

6-segment LED meter indicates pre-fader channel level. The top segment peak indicator will illuminate red if any of the multiple sample points in the signal chain approach 3dB of clipping. A yellow LED illuminates in the caution zone at +8 reference level. Four green LED segments indicated signal levels of 0, -6, -12, and Signal Present. The signal present LED first illuminates at approximately -30 and increases in brightness with level until it is at full intensity. Best operation is achieved when the bottom 3 green LEDs are illuminated with average input signals with occasional short yellow/red bursts of the +8 and peak LEDs.

100mm VCA Channel Fader

This fader adjusts the voltage being applied to the channel's VCA control electronics. This voltage is mixed with any of the assigned VCA group voltages to create the final control voltage (CV) for the channel's VCA element (as described above). This VCA element controls the Post fader signal level within the channel.

Solo Switch - Internally Illuminated

This switch will illuminate yellow when activated. It will route channel signal to the Master section for display on the Master solo meters and into the monitor/headphone systems. A switch within the Master section determines if the signal is sampled pre-fader (PFL) or post fader/post pan pot (AFL). When in pre-fader mode, it will route the pre-fader mono signal to the Master section. In AFL (post-fader) mode, the channel post fader/post left-center-right signal is fed to the Master section. The Master section also includes a SOLO CLEAR switch, which will cancel any Solo switches selected as well as an INPUT PRIORITY switch which will allow an input channel Solo to temporary cancel an output solo.

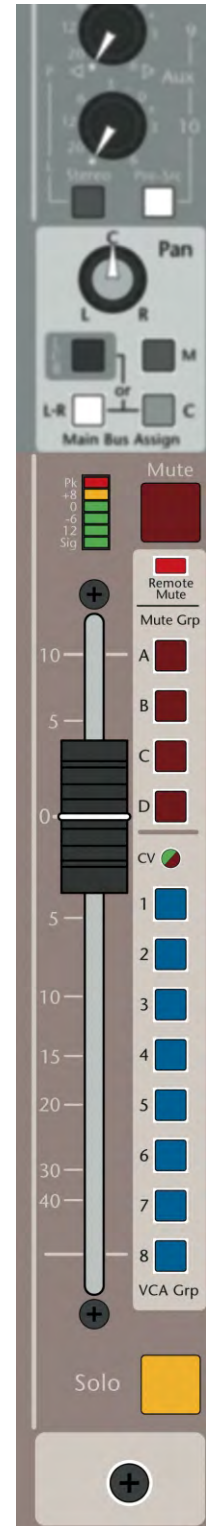

MONO INPUT MODULE REAR PANEL CONNECTORS

1/4" TRS Direct Output Connector

The connector provides a 100 Ω , impedance-balanced line level output of the input channel signal. The front panel Direct Output switch selects the signal between a Post-fader source and a Pre-fader source. The default signal for the Pre-fader position is AFTER the (1) microphone pre-amplifier but before all other processing. Additional sources for this output include (2) post high pass filter/insert point, and (3) post EQ. This utility output can be used to feed a multi-track recording device, effect device, or to feed another mixing or processing device including distributed monitor mixing systems.

Any changes to the pre fader direct output source options should be made by a qualified technician.

1/4" TRS Insert Connector(s)

External processing or effects electronics can be inserted into the channel signal path after the variable high pass filter. Examples of external devices includes additional equalization, notch filters, compressors, limiters, vocal doublers, reverb devices, etc. The insert sent has an output impedance of 100 ohms (un)balanced and the insert return has an input impedance of 10k ohms (un)balanced.

Spectra-T/Ti includes an INSERT ON switch with LED to activate the return (the Insert send signal is always active) in the Spectra-T/Ti mono channel's signal path. The insert return is always active on Spectra-C/Ci consoles. NOTE: The user should ensure that any device inserted into the channel is capable of maintaining the signal integrity of the console. The device must be able to accept a +22dBu signal without clipping, and have an output impedance of 100 Ω or less and be capable of driving +22dBu into a 2k Ω load.

1/4" TRS Line Input Connector

This connector accepts line input signals and has an input impedance of >10k ohms. When the front panel source switch is selected to line input, signal is first sourced from this connector. If nothing is plugged into this connector, the XLR input is normalled through this connector as a line input signal. The line input may be balanced or unbalanced signal.

XLR Input Connector

This connector accepts microphone or line input signals, as determined by the front panel input source switch and if the 1/4" TRS line input connector is occupied. When the front panel input source switch is in the microphone position, this XLR connector will be used as a microphone input and will have an input impedance of >3K Ω . When the input selector source switch is in the LINE input position and nothing is plugged into the 1/4" line input connector, this XLR connector is used as a balanced line input with an input impedance of >10k Ω . If a connector is plugged into the 1/4" line input connector, the XLR connector will always be configured as a microphone input connector with an input impedance of >3 k Ω . This is a locking connector. To remove an XLR cable, depress the Tab on the console connector before attempting to remove the cable plug from the console connector.

Spectra C or T
Single-Point Insert Jack
Unbalanced Send/Return

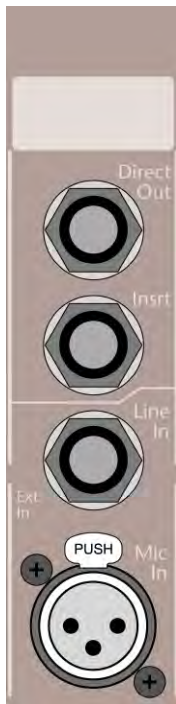

Spectra Ci or Ti
Dual Insert Jacks
Balanced Send/Return



STEREO LINE INPUT SECTION

TRS/RCA Line Input Switch

Selects the stereo input source between the rear-panel 1/4" TRS jacks (20k Ω balanced @ +4dBu) and the RCA connectors (10k Ω unbalanced @ -10dBV).

Left Input Polarity Reverse Switch

This switch reverses the electrical input polarity of the left input signal. Use of this switch may alter the sound quality of an input signal relative to other channels.

Left Input Gain Control

This control is used to adjust the input gain of the left line input for optimum electrical performance without producing audible noise (hiss) at high gain settings. The channel LED meters and the solo meters are used in assisting in setting the control for correct gain. Separate left and right input gain controls are provided to allow for better signal optimization when operated in split track mode.

Right Input Polarity Reverse Switch

This switch reverses the electrical input polarity of the right input signal. Use of this switch may alter the sound quality of an input signal relative to other channels.

Right Input Gain Control

This control is used to adjust the input gain of the right line input signal for optimum electrical performance without producing audible noise (hiss) at high gain settings. The channel LED meters and the solo meters are used in assisting in setting the control for correct gain levels. Separate left and right input gain controls are provided to allow for better signal optimization when operated in split track mode.

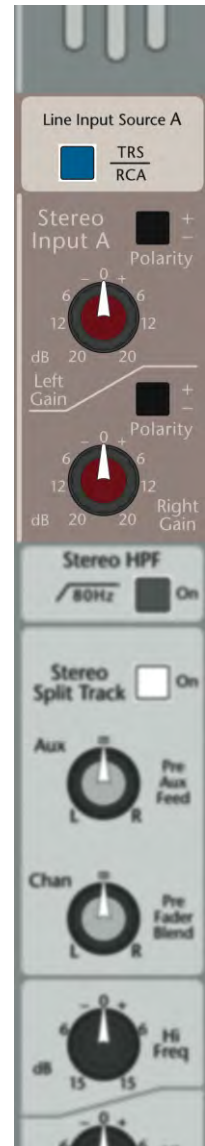

STEREO LINE INPUT CHANNEL - SPLIT TRACK CONTROL

Split Track Mode On Switch with LED

This switch converts the channel from conventional Stereo input operation to a dual mono "Split Track" channel. This function is most useful when dealing with the Voices-Left/Music-Right sources commonly used in House of Worship performances. The two Split-Track controls allow the operator to independently control the blend of the L&R channel signals feeding both the Auxes and the Main buses.

Aux Send Split Track Control

When the "Split Track" mode switch is pressed, the Aux Send split track control will be active. When this control is set fully counter-clockwise, the pre-fader source for the auxiliary sends is the left line input-only. When set fully clockwise, the pre-fader source for the auxiliary sends is the right line input-only. When set to its center position, there is an equal amount of left and right input signal being sent in summed-mono to the auxiliary send controls. From the center position, turning the control clockwise will increase the amount of right input while decreasing the left input signal being sent to the auxiliary controls. Turning the control counter-clockwise will increase the amount of left input while decreasing the right input signal being sent to the auxiliary controls.

Chan Send Split Track Control

When the "Split Track" mode switch is pressed, the Chan split track control will be active; this effectively turns the stereo signal within the module into a mono signal. The Blend control allows the operator to adjust the mixture of the L&R signals making up that mono mix. When this control is set fully counter-clockwise, the pre-fader source for the mix assignment is the left line input. When set to its center position, there is an equal amount of left and right input signal being sent in summed-mono to the mix assignment controls. From the center position, turning the control clockwise will increase the amount of right input while decreasing the left input signal being sent to the mix controls. Turning the control counter-clockwise will increase the amount of left input while decreasing the right input signal being sent to the mix controls.

LINE INPUT CHANNEL - STEREO EQUALIZATION SECTION

Left-Right High Pass Filter Switch

The switch (at the top of the section, above the split track control) activates an 80Hz @-18dB per octave high pass filter on both the left and right input signal paths of the stereo input channel.

Left-Right High Frequency Level Control

Adjusts the high frequency shelving cut/boost between +/-15dB. The center "0" position of this control has a detent to indicate that it is having no effect. Boost or cut of the high frequency level control is usually used for minor tonal adjustments. Use of this EQ control will affect both the left and right signal paths.

Left-Right High-Mid Frequency Level Control

Adjusts the high-mid frequency bell-shaped cut/boost between +/-15dB. The center "0" position of this control has a detent indicating "no effect." Use of this control will affect both the left and right signal paths.

Left-Right Low-Mid Frequency Level Control

Adjusts the high-mid frequency bell-shaped cut/boost between +/-15dB. The center "0" position has a detent to indicate it is having no effect. Use of this EQ control will affect both the left and right signal paths.

Left-Right Low Frequency Level Control

Adjusts the low frequency shelving cut/boost between +/-15dB at the corner frequency selected. The center "0" position of this control has a detent to indicate that it is having no effect. Use of this EQ control will affect both the left and right signal path.

Low Frequency 120Hz/60Hz Selection Switch

This switch selects the corner frequency of the shelving low frequency control. The 120Hz position will have a more dramatic effect on low frequency signals than the 60 Hz position. Correct frequency selection should be performed by listening for the desired effect on the input signal.

EQ On Switch with LED

This switch inserts the Left and Right EQ circuitry into the signal path. Stereo EQ activation is displayed by the illumination of an LED next to the EQ ON switch. When not in use, it is suggested that the EQ switch be kept in the OFF position for best phase-shift performance.

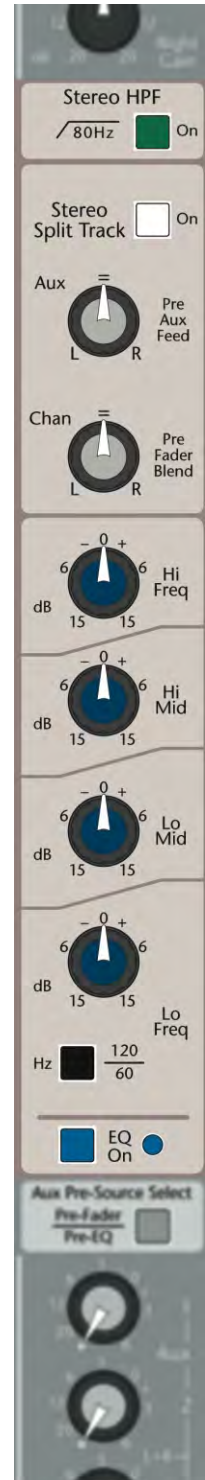

STEREO LINE INPUT CHANNELS - AUX SEND SECTION

Channel Pre-Fader/Pre-EQ Switch (Pre-Source Select)

This switch selects the Pre signal source for Aux 1-10 between Pre-Fader or Pre-EQ. This switch is relevant only when an associated (4) Aux Pre-Source switch is selected.

Aux Level Control 1-4

Controls the mix level of the input channel into Aux mix buses 1-4. These Aux feeds are always a summed-mono blend of the L & R channel signals. Source for this signal is determined by the Aux 1-4 Post-Fader/Pre-Source switch.

Aux 1-4 Pre/Post Fader Switch

This switch selects the signal source for Aux 1-4 between Post-fader or Pre-Source

Aux 5 Level Control

The Aux 5 level control adjusts the amount of the Left channel signal feeding Aux mix bus 5. When the Aux 5-6 L+R switch is selected, this aux signal becomes a mono blend of the left and right channel signals.

Aux 6 Level Control

The Aux 6 level control adjusts the amount of the Right channel signal feeding Aux mix bus 6. When the Aux 5-6 L+R switch is selected, this aux signal becomes a mono blend of the left and right channel signals.

Aux 5-6 L+R Switch

This switch reconfigures the feed to the auxiliary controls between the Aux 5-Left / Aux 6-Right stereo signals into a mono blend of the left and right signals to both controls.

Aux 5-6 Post -Fader/Pre-Source Switch

This switch determines the signal source for Aux 5-6 between Post fader and the earlier defined Pre-Source.

Aux 7-8 and Aux 9-10 Controls

The controls for Aux pairs 7-8 and 9-10 operate in the same manner as the controls of Aux 5-6.

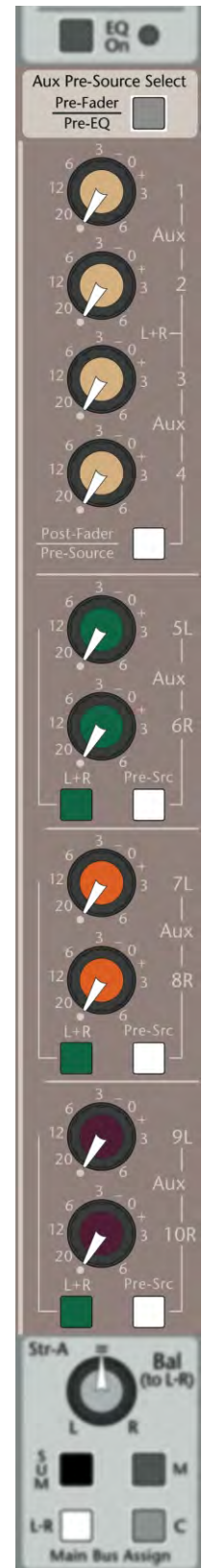

STEREO LINE INPUT CHANNELS - BUS ASSIGNMENT AND BALANCE

Balance (Pan) Control (To Left-Right)

In both stereo and split-track mono operation, this control feeds the post fader signal to the L-R assignment switch (dual-mono or stereo) and controls the proportion of signal feeding the left and right mix buses. When at the center position, both left and right output signals are equal. When the SUM switch is depressed, this control acts then as a PAN control positioning the now summed mono signal within the stereo pan image.

Sum Mono Switch (Dual Mono Effects Return Mode)

Depressing this switch sums the Left and Right signal into mono for special applications. With the use of this switch, the channel may be used as a dual-mono Effects Return channel. This is possible because of the separate input gain controls and polarity reverse switches on the inputs, allowing the adjustment of the gain or balance between two independent line inputs (effect devices).

Mono Assignment Switch

Assigns the mono (L&R equally mixed) post fader input signal to the Mono mix bus. It is used as a general-purpose post fader output for use as an additional primary console output, Aux or matrix send including use for surround or sub-woofer mixes.

L-R Assignment Switch

When in normal Stereo mode, assigns the post fader stereo signal to the Left-Right mix buses through the Balance Control. When in Split Track mode, this switch feeds the output of the split track mix control to the balance control.

Center Assignment Switch

Assigns the mono (L&R equally mixed) post fader input signal to the CENTER (additional mono) mix bus. When this channel is being used for music playback, the usual assignment locations will be the Left-Right mix buses with assignment to the Center channel not usually used. Assignment to the Center (Mono) mix bus is provided for situations where the center bus is being used to feed a discrete mix to another location or it is being used for the primary output of the console to drive a Mono sound system.

NOTE:

If the Split Track button is depressed, the L&R channel signals have already been combined/mixed by the use of the Blend control. So, for all switches involving the L&R channel signals (L-R, Mono, Center, and SUM), this fact should be taken into account. If the Blend control is set for full Left or full Right, the L&R combination that these switches call for will be modified by that earlier Blend setting. If no L or no R is present because of a full-Blend, then that missing L or R signal will NOT be combined by these later assignment switches.

Discrete Sub Woofer feed From the Mono Assignment Bus

The MONO bus may be used as a fixed level discrete feed to a sub-woofer system. The Left-Right, Center, and Mono main outputs are controlled from a single VCA master fader maintaining balance between all outputs including the MONO sub output when master signal levels are changed.

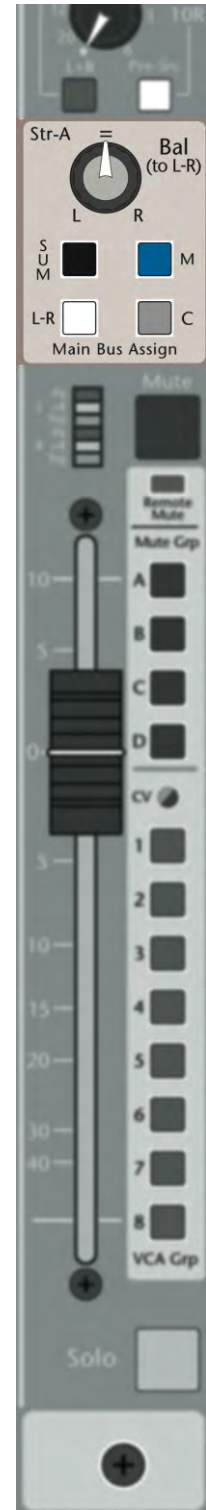

STEREO LINE INPUT CHANNELS - MUTE, VCA, SOLO and LEVEL CONTROL

Local Mute Switch - Internally Illuminated

Activation of this switch will mute the primary outputs as well as all pre and post fader auxiliary sends of the channel. When depressed, it will illuminate RED, indicating the status of this local mute only; another LED located beneath this switch indicates the status of any remote activated mutes. Activation of either mute system will not affect the channel's metering or the Solo-PFL signals, these are both located Pre-Fader/Pre-Mute. However, the channel's Solo-AFL signal is Post-Fader/Post-Mute (and Post-Assign), so if a channel is muted (or not assigned), no Solo-AFL will be available.

Remote Mute Activated Led

This LED will illuminate red when a mute command is received from any of the possible 12 remote mutes (8 VCA mutes + 4 Mute Groups).

Scene Mute Preset Switches A Thru D

When any of these switches are selected, it will cause the input channel to mute (and Remote Mute LED to illuminate) when the associated Mute Group switch within the master section is activated. Activation of a scene mute affects the channel in the same way a Local Mute does.

VCA Status Indicator (CV= Control Voltage)

The VCA status LED will illuminate in varying levels of green in proportion to voltage being applied to the VCA elements. This voltage is controlled by the channel fader as well as any of the 8 VCA master faders that may be assigned to the channel. This LED will turn red if the voltage being applied approaches the maximum allowable. The CV circuitry will then limit the voltage being applied to the VCAs to prevent the channel fader gain from exceeding the 20dB design limit.

VCA Assignment Switches 1 through 8

When any of these switches are depressed, it allows the associated master VCA level to have parallel control of the channel VCA elements. Any combination of switches may be chosen, all of which will sum together to create the final voltage being applied to the VCA elements. Maximum voltage being applied to the VCA elements is limited and indicated by the VCA status (CV) LED turning red (see above). These switches also act as presets for 8 additional scene mutes, but limited to the same assignment groups as the VCA. When any of the associated VCA mute switches within the master section are activated, the channel will be muted in the same manner as from the Mute Group section of the console.

Channel Level Meters

2 x 3 segment LED meter indicates pre-fader channel level. The top segment (1 left, 1 right channel) peak indicator will illuminate red if any of the multiple sample points in the stereo signal chain approaches 3dB of clipping. A yellow LED on each channel illuminates in the caution zone at a +8 reference level. The green signal present LED first illuminates at approximately -30 and increases in brightness with level until it is at full intensity on each channel. Best operation is achieved when the green LED's are illuminated with average input signals with only occasional short yellow/red bursts of the +8 and peak LED's.

100mm VCA Channel Fader

This fader adjusts the voltage being applied to the channel's VCA control electronics. This voltage is mixed with any of the assigned VCA group voltages to create the final control voltage (CV) for the channel's VCA elements (as described above). These VCA elements controls the Post fader signal levels within the channel.

Solo Switch with Internal Illumination

This switch will illuminate yellow when activated. It will route signal to the master section for display on the Master solo meters and into the monitor/headphone systems. A switch within the master section determines if the signal is sampled pre fader or post fader/post pan pot. When in pre fader mode, it will route the pre fader stereo signals to the master section. In post -fader mode, the channel post fader-post left-center-right signal is fed to the master section where inclusion of the center signal to monitors and headphones is determined. The master section also includes a SOLO CLEAR switch, which will cancel any mute switches selected as well as an INPUT PRIORITY switch, which will allow an input channel solo to temporary cancel an output solo.

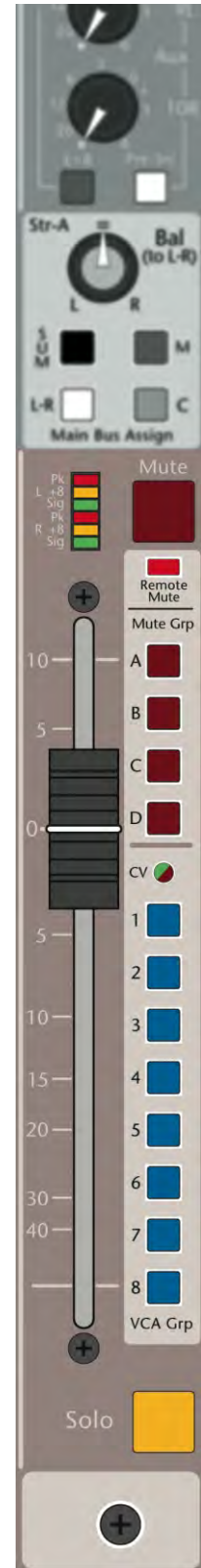

STEREO LINE INPUT CHANNELS - REAR PANEL CONNECTORS

Left And Right RCA Input Connectors

Provides for unbalanced line level inputs to the channel's left and right inputs.

Design level is -10dBV

Input impedance is 10K Ω unbalanced.

1/4" TRS Left and Right Balanced Input Connectors

Provides for balanced line level inputs to the channel's left and right inputs.

Design level is +4dBu

Input impedance is 10K Ω balanced

The input signal may be balanced or unbalanced.

If only a single (mono) signal is available, plugging into the Left TRS jack will feed that signal equally to both Left & Right inputs of the channel (through the Right TRS normal contacts). Plugging into the Right TRS jack will break that normalled connection and feed that new signal into the Right side of the channel.

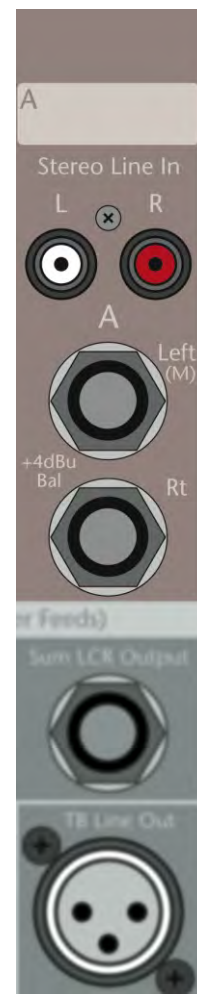

MASTER SECTION

The following pages describe the controls and connectors of the Spectra Master section.

VCA CONTROL SECTION (x8)

VCA Mute Group Switch (Internally Illuminated)

Though not a direct part of the VCA system, the VCA Mute Group switches share the input channel VCA Group assignment switches to create additional mute groups beyond the 4 discrete mute groups. The result is a total of 12 mute groups (8 VCA Mute Groups + 4 Discrete Mute Groups). When a VCA mute group switch is depressed, all input channels assigned to that VCA group will go into a mute state and the Mute switch will illuminate Red.

100mm VCA Master Group Fader

This fader will modify the voltage that is being applied to input channel VCA elements on those input channels that are assigned to the associated VCA Group. This control has a range of from infinite cut off to +10dB of gain above unity. On each channel, the control voltage from this fader and all other assigned VCA Grp faders is mixed with the channel fader voltage to create the final control voltage for the channel VCA.

Unity LED Indicator

This LED will illuminate when the associated VCA master fader is at its "unity" position. This is the position where input channel VCA assignments may be added or removed from that master control channel without any discernable level change.

VCA Group Solo Switch (Internally Illuminated)

When pressed, this (electronically latching) switch will activate the solos of all input channels that are assigned to the VCA Group. The channel solos will respond as if the operator had simultaneously depressed the Solo switches of all of the channels assigned to the VCA Group master. The channel solos will follow the mode and function determined by the Master Solo switches (See Master Output Section description).

NOTE:

If no channels are assigned to the VCA Group, this Solo switch will still illuminate, but the Solo system itself will not be activated; assigning a channel to the VCA Group while this switch is active will then activate the Solo system. If channels ARE already assigned to the VCA Group when the VCA Solo is depressed, the channel solos will activate as previously described. If a channel's (now active) solo switch is pressed, nothing obvious will occur; that channel and all other assigned channels will continue to be solo'd. If the VCA Solo switch is again pressed, unlatching it, all channels previously solo'd because of their assignment to that VCA Group will be released from solo. However- the channel whose solo switch was pressed (once) while the VCA Group solo was active will remain solo'd. The channel solo switches are still active beneath the VCA Group solo command. They continue to latch and unlatch invisibly while the VCA Group solo is in effect. This allows the operator to Solo an entire VCA group of channels and then select a subset of that group by pressing the desired channels' solo switches. When the VCA Group Solo switch is re-pressed (clearing it), only the previously selected channels will remain solo'd. Pressing the Solo Clear switch at any time will clear all of the solos- channel or VCA based.

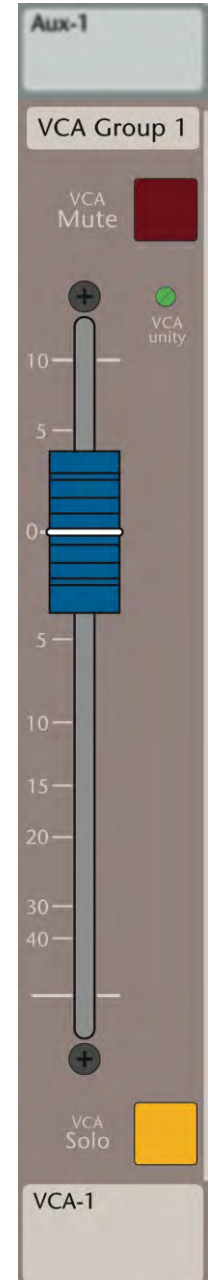

AUX MASTER OUTPUT CONTROL (x10)

Aux Output Mute Switch (Internally Illuminated)

When activated, this switch will mute the associated Auxiliary output including post fader sends to the matrix system. Pre-fader matrix sends are not affected by this mute switch. This switch will not affect the PFL solo operation of the console or the bus level (bicolor LED) signal monitoring.

100mm Aux Output Master Level Control

Adjusts the output level of the associated auxiliary output.

Bus Level LED Monitor

This bi-color Red/Green LED monitors the signal level on the associated Aux mix bus. Varying intensity Green indicates proper bus levels while red indicates approaching overload within the Aux circuitry. Overload is sensed after the mix amp, at the insert return and after the fader amp. The inclusion of this LED aids the operator in setting up the correct gain structure of the console.

Talk To Aux Assignment Switch

The talkback preset switch allows the talkback system (or oscillator) to feed the associated Auxiliary mix bus when activated from within the Master Talkback control section.

Left, Right, Center and Mono Assignment Switches

Allows the associated post auxiliary fader signal (post insert) to feed any of the primary output mix buses of the console. This is useful when an operator wishes to form an analog subgroup for the purposes of inserting a common signal-processing device using an Aux group mix. Assignment to the Mono bus allows for any of the Aux mix buses to be used as a variable mix-level discrete subwoofer feed.

Matrix Pre/Post Fader Switch

This switch selects the source of the signal feeding the matrix system between pre and post the Auxiliary master fader. If post-fader, the Mute switch will also affect the send to the matrix

Polarity Reverse Switch

When this switch is depressed, it reverses the polarity of the associated rear-panel XLR output connector. When this auxiliary output is used as a monitor output, reversing the polarity MAY allow for a increase in gain before feedback. When this auxiliary output is used to feed an effects devices, reversing the polarity will affect the audio characteristics of interaction between wet and dry signals in how they sum together when returned into the console.

Aux Output Solo Switch (Internally Illuminated)

The Solo switch assigns the associated auxiliary signal into the console monitor and headphone systems. Signal may be monitored pre fader or post fader as determined by the SOLO PFL/AFL switch within the Master section of the console.

Stereo Solo System Operation on Aux Masters

When a single solo switch within the Aux master section is activated, the signal is sent to the Headphone and Monitor system, including Solo meters, in mono (both L&R sides of the solo system are fed). When an ODD/EVEN pair of Aux outputs is simultaneously solo'd, the odd Aux will feed the left solo bus while the even Aux will feed the right solo bus into the Headphone, Monitor, and Solo meter system. This allows the operator to accurately monitor a stereo-configured Aux pair.

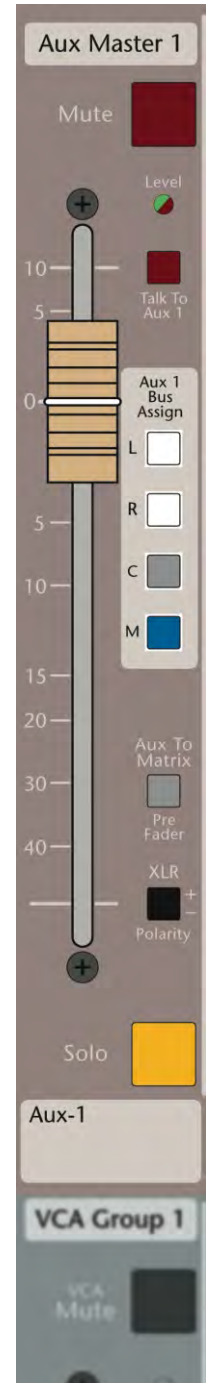

AUXILIARY OUTPUT REAR PANEL CONNECTORS

1/4" TRS Aux Insert : 4 x TRS for C/T or 8 x TRS for Ci/Ti

External processing or effects electronics can be inserted into the Aux bus signal path after the summing amp. Examples of external devices include additional equalization, notch filters, compressors, limiters, etc. The insert sent has an output impedance of 100 ohms (un)balanced and the insert return has an input impedance of 10k ohms (un)balanced.

NOTE: The user should ensure that any device inserted into the Aux bus is capable of maintaining the signal integrity of the console. The device must be able to accept a +22dBu signal without clipping, and have an output impedance of 100 Ω or less and be capable of driving +22dBu into a 2k Ω load.

XLR Balanced Output

This is a 100 Ω electronically balanced line level output on an XLR connector designed to drive a 600 Ω load or greater. The Polarity reverse switch located at the Aux fader will reverse the polarity of this XLR connector.

HEADPHONE CONNECTOR (C/T)

1/4" and a 1/8" headphone connectors are located under the front armrest (below the master section) plus this additional 1/4" Headphone connector is located here on the rear of the -C/T console.

There are additional 1/4" and 1/8" jacks on the rear of the -Ci/Ti console (their position is shown later).

Spectra C or T
Single-Point Insert Jack
Unbalanced Send/Return



Spectra Ci or Ti
Dual Insert Jacks
Balanced Send/Return

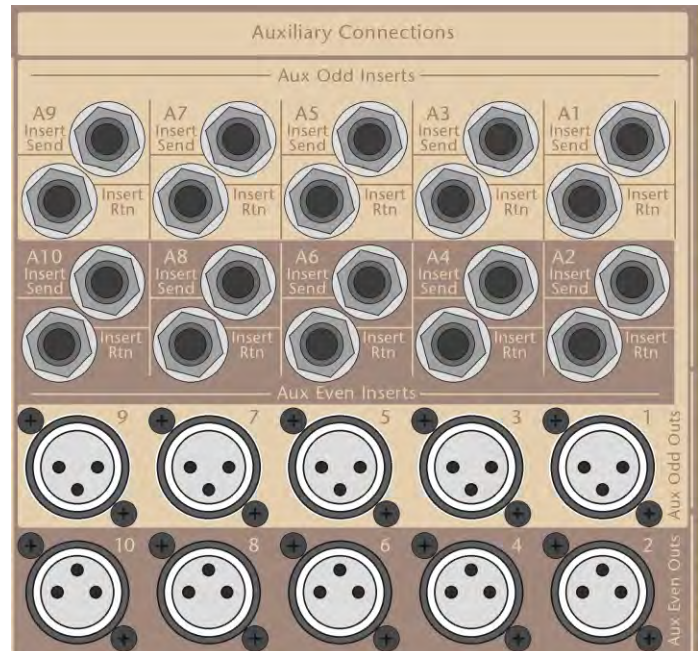

MATRIX OUTPUT SECTION (x4)

Matrix Output Metering (LED ladder)

Displays the actual output level of the associated Matrix system (these meters are shared with the Solo system when the Solo Active LED is illuminated). See the metering section on page 30 for more information.

Aux To Matrix Level Controls (1-10)

These level pots (1 through 10) control the amount of Aux signal being fed to the associated Matrix system. A switch on each Aux output section determines if this signal is derived pre or post its associated Aux master fader.

Left, Right, Center, and Mono Level Controls

These Pre-Fader level controls (pre VCA element) determine the amount of the associated Left, Right, Center and Mono signals that are being fed into the associated matrix system. No post fader source is provided as this would duplicate VCA control operation when the associated VCA element is activated. The equivalent of a post fader signal is achieved when the matrix VCA element is activated as it will then follow movement of the master fader.

External Input Level Control

This pot provides for level control of an external signal into the associated Matrix system. This may be a common external input signal if nothing is plugged into the external input other than External Input 1 or individual inputs if connectors are plugged into each individual external input connector. See rear panel for more detail.

Matrix Mute Switch (Internally Illuminated)

When this switch is activated, will cause the output of the associated Matrix system to mute. The button will illuminate Red when activated.

Solo Switch (Internally Illuminated)

The matrix output signal may be monitored on speakers or headphones using the Matrix solo switch. This signal source is monitored pre-fader (PFL) or post the matrix level control (AFL) as determined by the Solo master PFL/AFL mode switch.

Matrix Output Level Control

Controls the output level of the associated Matrix. The output level can also be put under the control of the House Master fader with the next switch ...

Control Matrix w/ House Master Switch with LED

When activated, this switch will allow the console's House Master fader to have level control over the Matrix output (along with the matrix's own level control). This allows for uniform system level control adjustments when the Matrix is being used as a feed to under balcony or fill speakers.



MATRIX OUTPUT REAR PANEL CONNECTORS

1/4" Balanced TRS External Matrix Input (4 x TRS)

A 1/4" (10k Ω) balanced line input is provided to each matrix output section. These jacks are linked to the next adjoining external input connector via the normalling contacts of the TRS jack. If an input is plugged into the first external matrix input, this signal is sent to all higher numbered external matrix inputs until a connector is plugged into the next input connector. Because of this feature, one input can access all four matrix channels or four discrete inputs can be provided with one feeding each matrix channel.

1/4" TRS Matrix Insert : 4 x TRS for C/T or 8 x TRS for Ci/Ti

External processing or effects electronics can be inserted into the Matrix bus signal path after the summing amp. Examples of external devices include additional equalization, notch filters, compressors, limiters, etc. The insert send has an output impedance of 100 ohms (un)balanced and the insert return has an input impedance of 10k ohms (un)balanced.

NOTE: The user should ensure that any device inserted into the Matrix bus is capable of maintaining the signal integrity of the console. The device must be able to accept a +22dBu signal without clipping, and have an output impedance of 100 Ω or less and be capable of driving +22dBu into a 2k Ω load.

Matrix XLR Balanced Output (4 x M-XLR)

These outputs provide a +4dBu balanced line level output signal (100 Ω balanced) of the Matrix signals.

NOTE: The Matrix Outputs are relay-muted while the Console is powering up; a valid PSU-Good signal from either of the power supplies (time delay of ~4 seconds) will un-mute these outputs. Additionally, these outputs will immediately mute when the Console is powered down (or otherwise loses power). This feature prevents any console power-transition thumps from getting into the speakers when the system is driven from these outputs.

Spectra C or T
Single-Point Insert Jack
Unbalanced Send/Return



Spectra Ci or Ti
Dual Insert Jacks
Balanced Send/Return

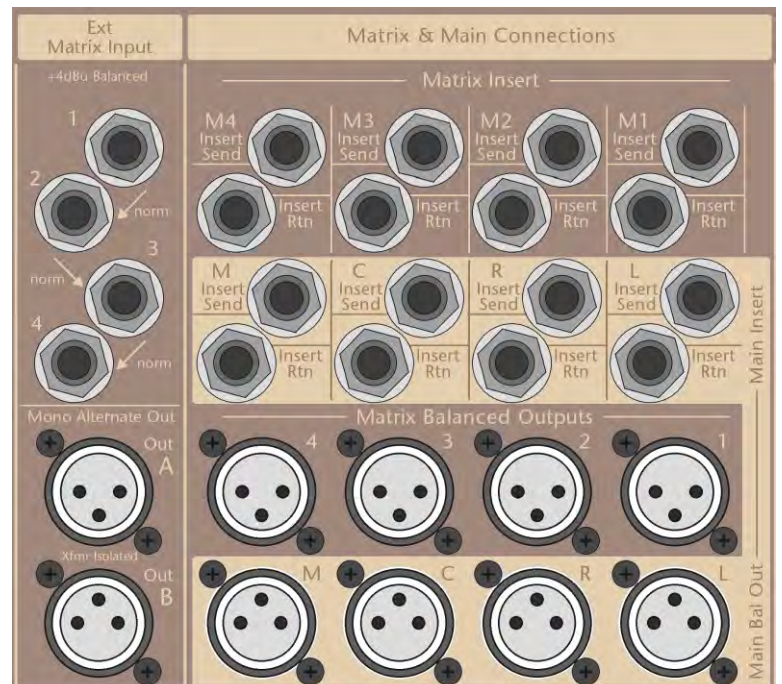

MASTER OUTPUT SECTION

VCA Remote On Switch with LED

This switch will allow the remote control of master and VCA group levels and discrete mutes by an optional external controller. The faders on the console set the reference levels from which the remote faders may attenuate to maximum or boost up to 10dB. The inclusion of this switch prevents remote control of the console when an operator is present. When no operator is present, the console may be preset in advance and made to be out of reach of unauthorized operators, but the remote level and remote control may remain available for general level and mute control. This is useful in house-of-worship and public installations where general use of the audio system is required without an operator present.

– This optional interface is not currently available and is intended for future development.

Peak/Signal Present Master LEDs

4 individual dual color LEDs monitor the Left, Right, Center and Mono mix bus levels. In normal operation, varying intensity of the green LEDs represents acceptable bus signal levels. Should any of these levels approach clipping, the associated LED will illuminate red. This should be an indication to the operator that input fader levels should be decreased until the red peak indicators are no longer activated. (Overall output levels can be adjusted by raising the master fader position to offset any decrease in level caused by lowering the input channel faders).

100mm House Master Fader

This fader controls the voltage being applied to the Left, Right, Center, and Mono VCA elements feeding the main outputs of the console. Any of the 4 Matrix sections may also be selected to follow this master fader. The result is accurate-tracking of volume changes to all primary outputs. (Two THAT Corporation VCA elements are operated in parallel within the Left, Right, Center and Mono signal paths for improved performance over that of a single VCA element). Any of the 3 Alt Outputs can be used if independent or slaved output level is desired for one or more of the Main outputs (see Alt Out description page).

Input Priority Switch with LED

This switch allows for easier solo use when the Spectra is being used as a monitor console. When activated it allows an input channel solo activation to override an output solo'd signal. When an input solo is cleared (locally or with the solo clear switch) the console reverts to the previous output solo position. This allows the operator to keep a critical Aux mix solo'd for monitoring purposes, but easily switch to monitor an input if necessary during a performance. Once the input channel has been listened to and cleared, the console reverts back to monitoring the original (critical) Aux mix.

Solo AFL Mode Center Yes-No Switch

Left-Center-Right post fader input signal is automatically routed to the master section for monitoring when a channel is solo'd in AFL mode. IF the center signal is being used for a purpose other than a center channel, it may be desirable for it NOT to appear as part of the solo'd signal that is being listed to. This switch will turn OFF the center signal feed to the monitor and headphone systems. The solo'd center signal will always appear on the center solo meter regardless of the position of this switch.

Solo PFL/AFL Mode Switch with LED

This switch selects the operation of the solo switches between PFL (pre fader signal monitoring in mono on mono inputs and stereo on stereo input channels) and AFL (post fader stereo or LCR) operating modes. This signal is fed to the monitor/headphone section as well as to the console Left-Center-Right solo meters.

Solo Active Indicator / Solo Clear Switch

When lit, this illuminated button indicates that the Solo system is active. A red Solo Active LED will also illuminate in the Master meter section.

Pressing this switch will clear the active solos. If in Input Priority mode, the first press will clear any Input solos, restoring the previous Output solos (if any). The next press will clear the Output solos.

Group Mute (Discrete Mute Scene) Activation Switches

Four internally illuminated (Red) switches activate the input channels discrete scene mute system. Master Mute functions may also be controlled externally if the Remote Control On switch is activated (optional).

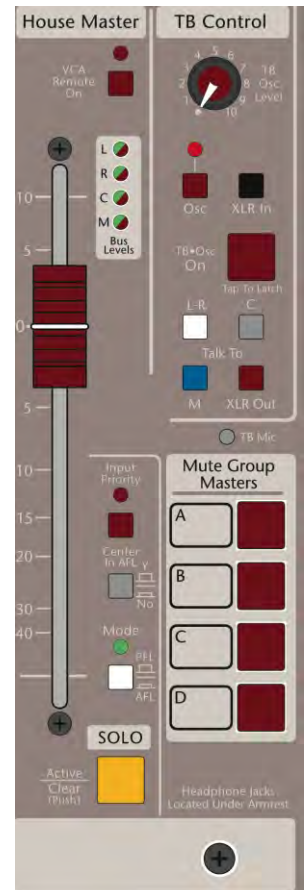

MASTER OUTPUT REAR PANEL CONNECTORS

1/4" TRS Left, Right, Center, And Mono Inserts: 4 x TRS for C/T 8 x TRS for Ci/Ti

External processing or effects electronics can be inserted into the Main bus signal path after the summing amp. Examples of external devices include additional equalization, notch filters, compressors, limiters, etc. The insert sent has an output impedance of 100 ohms (un)balanced and the insert return has an input impedance of 10k ohms (un)balanced.

NOTE: The user should ensure that any device inserted into the Main bus is capable of maintaining the signal integrity of the console. The device must be able to accept a +22dBu signal without clipping, and have an output impedance of 100 Ω or less and be capable of driving +22dBu into a 2k Ω load.

Left, Right, Center, And Mono XLR Balanced Outputs (4 x M-XLR)

These outputs provide a +4dBu balanced line level output (100 Ω balanced) signal for each of the 4 console primary outputs.

NOTE: The Main Outputs are relay-muted while the Console is powering up; a valid PSU-Good signal from either of the power supplies (time delay of ~4 seconds) will un-mute these outputs. Additionally, these outputs will immediately mute when the Console is powered down (or otherwise loses power). This feature prevents any console power-transition thumps from getting into the speakers when the system is driven from these outputs.

Spectra C or T
Single-Point Insert Jack
Unbalanced Send/Return

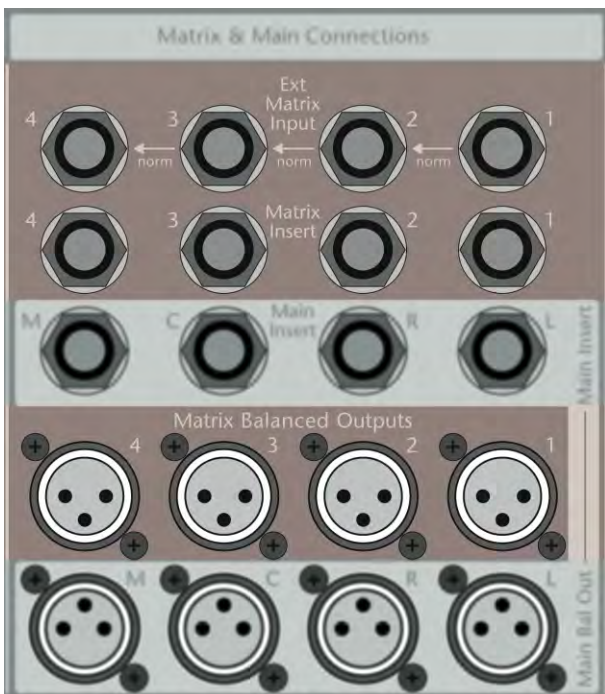

Spectra Ci or Ti
Dual Insert Jacks
Balanced Send/Return

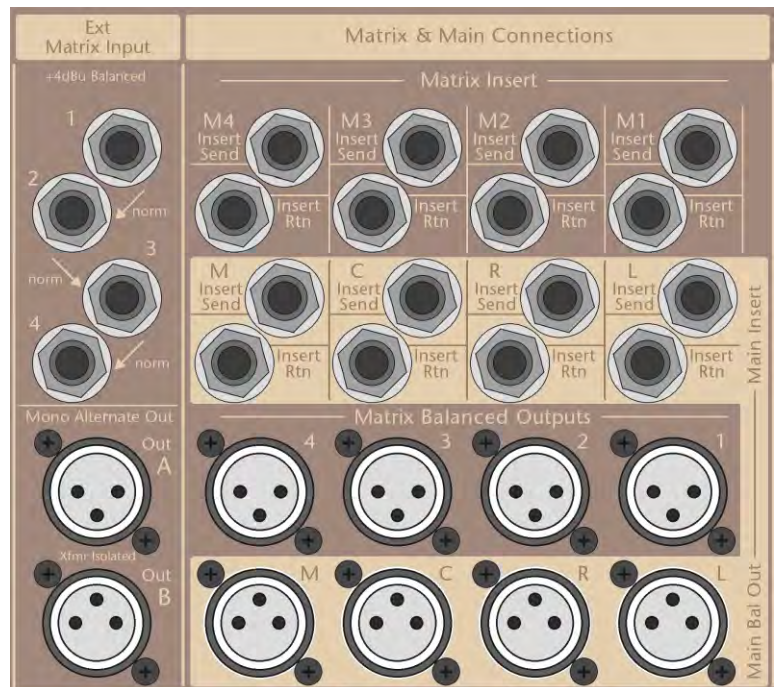

MONO ALTERNATE OUTPUTS (x2)

Pre-Fader Source Switch

Determines if the selected signal source is derived pre or post its associated output level control.

Mono Alternate Output Level Control

This pot controls the (mono) level of the selected alternate output signals.

Left, Right, Center, Mono, Aux 9, Aux 10 Source Switches

Determines signal source to be fed to the associated alternate mono output. These are summing switches and all selected sources mix equally together.

Main Purpose

The two mono alternate outputs provide additional level-controlled mono outputs from the console that may be derived from any mixture of the Left, Right, Center, Mono, Aux 9 and Aux 10 outputs. These signals may be selected pre or post their associated output fader. These Alt outputs are typically used to provide an independently controlled Main output, or used to feed a mono-mixed signal for remote recording. When used as a Main output, the Alt Out can either follow the House Master fader when the Pre-Fader switch is UP, or be totally independent of the house level when the switch is in the Down position. In either case, the associated level control still controls the final output.

Additionally, these +4dBu balanced XLR outputs (Alt Out A and Alt Out B) are transformer isolated and protected from external phantom voltages typically encountered when feeding broadcast camera equipment.

STEREO RECORD (ALTERNATE) OUTPUT

Aux 9-10 Pre-Fader Switch

This switch determines if the Auxiliary 9-10 signal sources are derived pre or post their associated output level control.

Left-Right-Center-Mono Pre-Fader Switch

This switch determines if the Left, Right, Center and Mono signal sources are derived pre or post their associated output level control.

Left/Right, Center, Mono, Aux 9-10 Source Switches

Determines signal source to be fed to the Stereo Record output. These are summing switches and all selected sources mix equally together.

Mute Switch with LED

This switch mutes the rear-panel outputs and illuminates the associated red LED.

Stereo Record Output Level Control

This pot controls the (stereo) level of this output signal.

Main Purpose

The Stereo Record output provides an additional level controlled stereo output that may be derived from any mixture of Left/Right, Center, Mono, and Auxiliary 9 (L) -10 (R) outputs. These signals may be selected pre or post their associated output fader. This output would usually be used as a record output but it may also be used as an output trim of any of the sourced signals.

Impedance-balanced left and right 1/4" TRS connectors are provided at a +4dBu operating level for the Stereo Record Output. (Output Impedance = 100 Ω Impedance Balanced).

RCA connectors are also provided for lower level outputs (-10dBV) of these signals to better match the input requirements of consumer grade recording devices.



MONITOR / HEADPHONE CONTROL

2 Speaker / 3 Speaker Monitor Switch

This switch selects between 2-speaker (stereo) and 3-speaker (LCR) monitoring. When 2-speaker monitoring is chosen, the center channel signal is fed to the left and right outputs as a "phantom center". When in a control room environment in a LCR installation, program material can be monitored in the same format as the Front-Of-House system, including LCR monitoring of the Solo AFL system. For single speaker monitoring (typically used for wedge monitors), the SUM OUTPUT connector on the rear panel is used which is a summed signal of left, right and center. It may also be used as a sub-woofer output.

Solo Trim Control

This rotary control will provide up to a +/-12dB variation of solo'd left-center-right signals in reference to the default monitored signal. This control affects only the solo audio path and does NOT affect the solo meters.

Solo Trim On/Off Switch

The solo system normally will operate in a calibrated mode. Activation of this switch will allow the solo trim control to adjust solo levels over a +/-12dB range.

Pre-Fader Switch (for Left/Right/Center/Mono)

This switch is common for both the headphone and monitor sources and determines if the Left, Right, Center and Mono signals are derived pre or post (House Master) fader. The Aux 9 and Aux 10 signals are always monitored post (Aux) fader.

Headphone Source Switches (all selected sources mix together)

L-R:

When selected, this switch will route the L&R outputs to the left and right stereo headphones.

C (enter):

When this switch is selected, it will route the Center output equally into the left and right stereo headphones, creating a "phantom center" image.

M(ono):

When this switch is selected, it will route the Mono output equally into the left and right stereo headphones, creating a "phantom center" image.

External Monitor Input Switch:

When this switch is selected, it will route the external Line input to the headphones from the rear panel left and right external input connectors.

Aux 9-10 Switch:

When this switch is selected, it will route a post level control Aux 9 (left) and Aux 10 (right) stereo signal to the headphones. This allows for monitoring of this set of auxiliary outputs as a default signal without using the solo system. This is useful when Aux 9-10 are being used to generate a separate record output.

Headphone Level Control

This control adjusts the stereo level being fed to the headphone system. All three headphone jacks are fed from this control: two below the armrest (1/4" & 1/8") and one on the Master rear panel (1/4").

Solo Off To Headphones Switch with LED

A solo signal will normally override any default signal source. When this switch is depressed, it will prevent the solo signal from overriding the selected default headphone signal. An LED will illuminate when this Solo Off switch is activated. This switch can be used if a dedicated output is desired: Select the desired signals to mix together (press their source switches to mix together), adjust the level. With the Solo Off switch depressed, the headphone outputs will NOT be interrupted by the solo system.

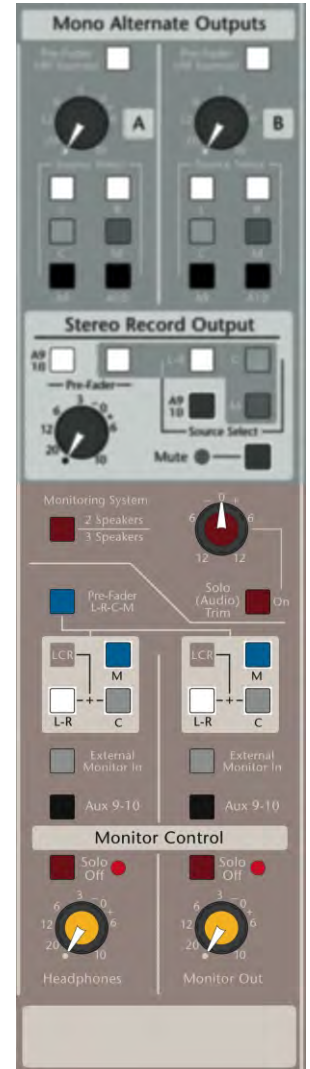

Pre-Fader Switch (for Left/Right/Center/Mono)

This switch is common for both the headphone and monitor sources and determines if the Left, Right, Center and Mono signals are derived pre or post (House Master) fader. The Aux 9 and Aux 10 signals are always monitored post (Aux) fader.

Monitor Source Switches (all selected sources mix together)

L-R:

When selected, this switch will route the L&R Outputs to the left and right monitor outputs.

C (enter):

When this switch is selected, it will route the Center Output to the center output of the monitor system.

When the Monitor System is set for 2-Speakers, a ‘phantom center’ is created by feeding the Center Output equally to both the L&R outputs of the Monitor system.

M(ono):

When this switch is selected, it will route the Mono Output to the center output of the monitor system.

When the Monitor System is set for 2-Speakers, a ‘phantom center’ is created by feeding the Mono Output equally to both the L&R outputs of the Monitor system.

External Monitor Input Switch:

When this switch is selected, it will route the External Line input to the monitors from the rear panel left and right external input connectors.

Aux 9-10 Switch:

When this switch is selected, it will route a post level control Aux 9 (left) and Aux 10 (right) stereo signal to the monitors. This allows for monitoring of this set of auxiliary outputs as a default signal without using the solo system. This is useful when Aux 9-10 are being used to generate a separate record output.

Solo Off To Monitors Switch with LED

A solo signal will normally override any default signal source. When this switch is depressed, it will prevent the solo signal from overriding the selected default Monitor signal. An LED will illuminate when this Solo Off switch is activated. This switch can be used if a dedicated output is desired: Select the desired signals to mix together (press their source switches to mix together), adjust the level. With the Solo Off switch depressed, the Monitor outputs will NOT be interrupted by the solo system.

Monitor (Speaker) Level Control

This control adjusts the stereo or LCR level being fed to the console monitor system. All 4 monitor outputs are affected by this control (L, R, C, and Sum)

Solo AFL Mode Center Yes-No Switch (Located in Solo Control Section)

Left-Center-Right post fader input signal is automatically routed to the master section for monitoring when a channel is solo'd in AFL mode. IF the center signal is being used for other than a center channel, it may be desirable for it NOT to appear as part of the solo'd signal that is being listed to. This switch will turn OFF the center speaker feed to the monitor and headphone systems. The channels solo'd center signal will always appear on the center solo meter regardless of the position of this switch.

Rear Panel Monitor Output Connectors

Impedance Balanced 1/4" output connectors are provided for Left, Center, and Right monitor outputs. An additional 1/4" Impedance Balanced output connector is provided which is a sum of the Left, Center, and Right signals. This connector may be used as a summed mono output to feed a sub-woofer system or to drive a mono wedge monitor system when the console is used as a monitor console.

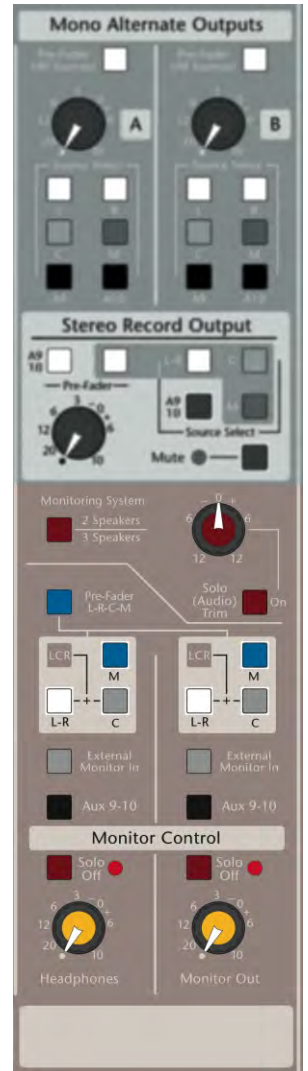

TALKBACK SYSTEM

Talkback Level Control

Adjustment of this pot will vary the talkback (and oscillator) levels to the pre selected talkback locations.

Osc (MIC / 1kHz Oscillator Switch) with LED

This switch selects the source of talkback signal between microphone (internal or XLR), or an internal 1 kHz oscillator. The LED will illuminate when the oscillator is selected.

Note: Both the Osc switch and the TB On switch must be activated (both must be illuminated) before the 1KHz signal can be sent to any selected Talk To destination.

XLR In (Internal/External Microphone Switch)

This switch selects between the internal microphone or the rear panel TB XLR connector as the talkback microphone source (also under-armrest TB XLR for later-production consoles).

TB • Osc On (Master Talkback Switch) internally illuminated

This is a smart switch that will act both as a momentary and latching switch depending on how it is depressed. Pressing and holding the switch down will activate the talkback system until the switch is released. Taping the switch quickly with turn the system on until another quick tap will turn it off. When the talkback system is activated, it will provide the talkback signal to preset locations including any pre-selected Aux master, the left-right, center, mono or external location. When depressed, it will also dim the console monitor system.

Left-Right Preset Switch

This switch pre-assigns the Left/Right mix bus as the destination of talkback signal (or oscillator).

Center Preset Switch

This switch pre-assigns the Center mix bus as the destination of the talkback signal (or oscillator).

Mono Preset Switch

This switch pre-assigns the Mono mix bus as the destination of the talkback signal (or oscillator).

XLR-Out Preset Switch

This switch pre-assigns the talkback system (or oscillator) to the balanced XLR external TB output on the rear panel of the console.

Internal Talkback Microphone

An internal (electret) microphone is provided behind the front panel of the console and is the default signal to the talkback system. This is usually adequate for general use, however, the provided XLR connector(s) can be used to patch in an external TB mic. Pressing the XLR In switch selects the Ext mic(s) and mutes the internal mic.

Rear Panel XLR Talkback Input

This XLR input can be used for microphone level or low level line input signals. An internal jumper is provided to activate +18V phantom power to this connector. The default jumper position is OFF.

A duplicate XLR is located under the armrest (near the HP jacks) on later-production consoles. Both of these XLRs can be used simultaneously; the two signals will sum together.

Auxiliary Talkback Preset Assignment Switch

Switches on each of the Aux master output sections pre-assigns the talkback system (or oscillator) to feed the associated Aux mix bus when the Talkback system is active.

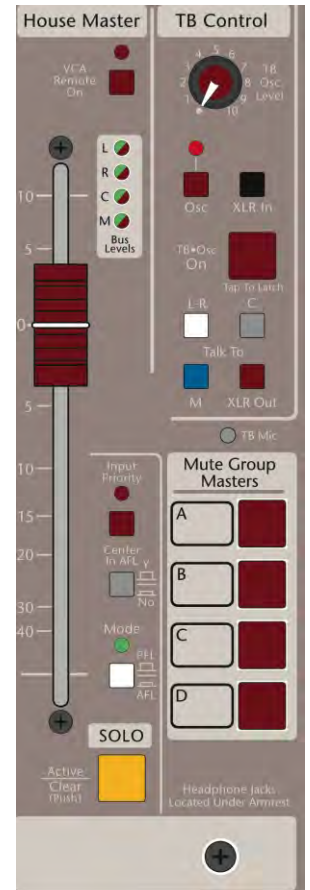

ALTERNATE OUTPUT CONNECTORS

Stereo Record Output (1 pair RCA / 2 x TRS)

RCA connectors are provided for low level outputs of the stereo alternate signal to better match the input requirements of consumer grade recording devices.

- 10dBV operating level, 1kΩ unbalanced
- 1/4" TRS connectors are also provided for the Stereo Alternate Output.
- +4dBu operating level, Output Impedance = 100
- Impedance Balanced

Mono Alternate Outputs A & B (2 x M-XLR)

Isolated XLR outputs are provided for each of the Mono alternate outputs.

- +4dBu operating level
- Output Impedance = 600
- Transformer Balanced / Isolated.

HEADPHONE CONNECTORS (Ci/Ti)

1/4" and a 1/8" headphone connectors are located under the front armrest (below the master section) plus these additional 1/4" and 1/8" jacks on the rear of the Ci/Ti console.

Spectra C or T



Spectra Ci or Ti



MASTER CONNECTORS (Monitor & TB)

Monitor Output (4 x TRS)

1/4" TRS output connectors are provided for Left, Center, and Right monitor outputs. An additional output connector is provided which is a sum of the Left, Center, and Right signals. This connector may be used as a summed mono output to feed a sub-woofer system or to drive a mono wedge monitor system when the console is used as a monitor console.

All 4 TRS outputs operate at +4dBu and are 100 Impedance-balanced

External Monitor In (2 x TRS)

These external Line inputs feed the headphone and monitor sections and can be selected to be monitored separately or combined with the other available sources.

1/4" TRS +4dBu
10K Balanced

TB In & Out XLRs (1F/1M)

This XLR input can be used for microphone level or low level line input signals. An internal jumper provides +18V phantom power to this connector.

Female XLR
2k input impedance
~30dB gain

This XLR output carries the Talk Back signal (Mic or 1kHz Osc) to the outside world if the XLR Out button is pressed on the front-panel TB section.

Male XLR
0dBu level
200 balanced



SYSTEM METERING

Aux Meters (X10)

A full time output meter is provided for each of the 10 auxiliary outputs. These are multi-segmented LEDs and display the actual output levels of the Aux Outputs of the console. (These ARE affected by mute switches or any other activity that may interrupt the output signals).

Note: These meters have a VU-type response and are not peak-reading. Average console levels will show up on the meters at or around the "0" mark.

Matrix Meters (X4) + Solo Metering

An output meter is provided for each of the 4 Matrix outputs. These are multi-segmented and display the actual output levels of the Matrix Outputs of the console.

Note: These meters have a VU-type response and are not peak-reading. Average console levels will show up on the meters at or around the "0" mark.

When a Solo switch is activated on the console, a Red LED below the Matrix 1 meter will illuminate to indicate that these meters are now displaying the solo'd signals. The PFL or AFL signals are then routed to the last three of these meters (with the first matrix meter deactivated) to display solo levels as mono, stereo, or Left-Center-Right. The levels displayed by the solo system are not affected by the solo trim control nor are they associated with any controls within the monitor or headphone section of the console.

Left - Right - Center - Mono Meters

Full time output metering is provided for Left, Right, Center and Mono outputs. These are multi-segmented LED's and display the actual output levels of the Main Outputs of the console. (These ARE affected by mute switches or any other activity that may interrupt the output signals).

Note: These meters have a VU-type response and are not peak-reading. Average console levels will show up on the meters at or around the "0" mark.



CONSOLE DIMENSIONS

FRONT VIEW

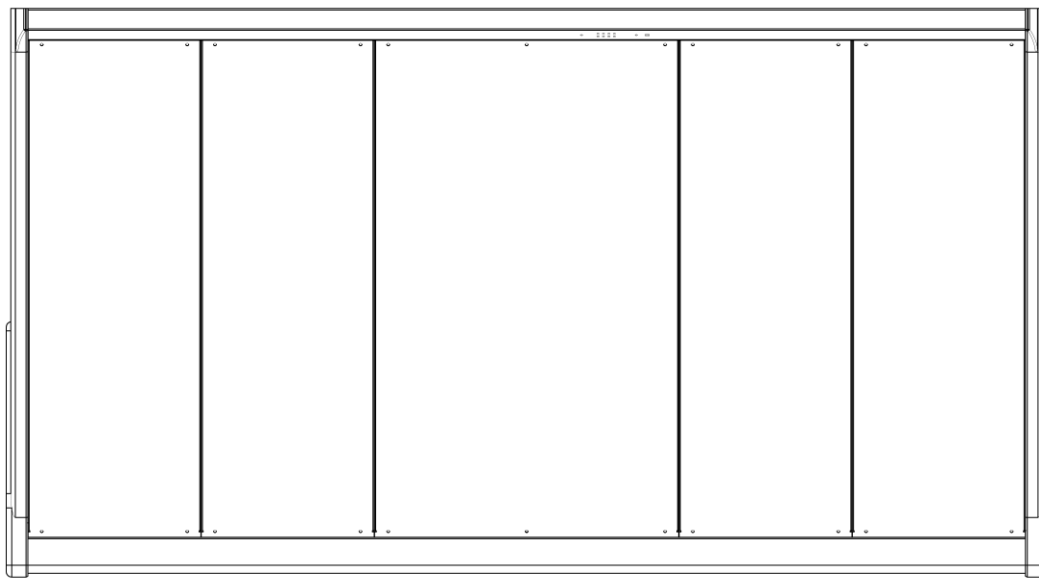
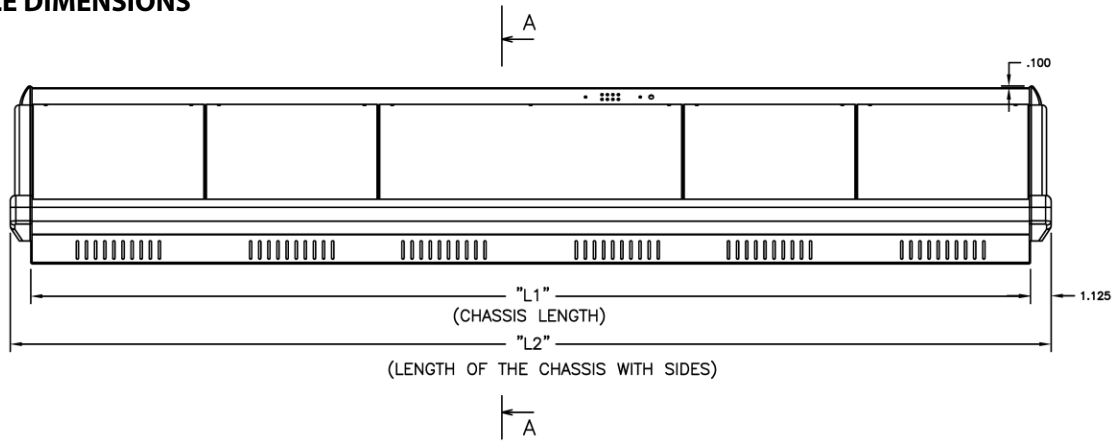

RIGHT SIDE VIEW

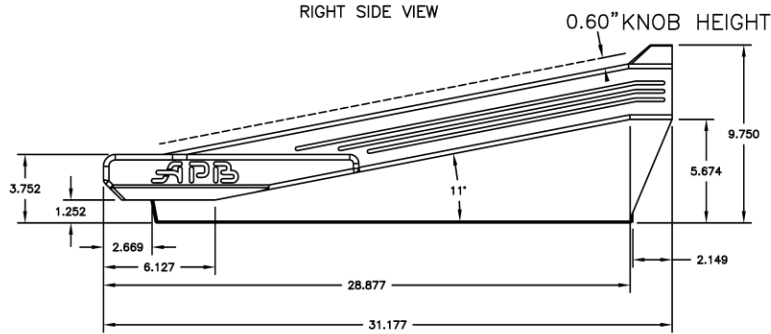

Length inches / Size	EXP	/24	/32	/40	/48	/56
L1 Chassis Only	28.7"	45.32"	54.82"	64.32"	73.82"	83.32"
L2 w/Side Cheeks	30.87"	47.57"	57.07"	66.57"	76.07"	85.57"
Weight-lbs. (kg)	80 (37)	125 (57)	145 (66)	165 (75)	185 (84)	210 (96)

TECHNICAL SPECIFICATIONS

All measurements ref to 20Hz to 20kHz BW unless otherwise noted	
Frequency Response (any input to any output)	+0/-0.5dB 20Hz to 20kHz (ref to 1kHz)
THD + Noise (Mic Input to Main Output)	<.02% @ +15dBu output (Channel VCA and Bus VCA both in-circuit)
Phase Response (Mic Input to Main Output)	+10/-15 degrees 20Hz to 20kHz (ref to 1kHz)
Noise	
Mic EIN	-128dBu @ 60dB gain, 150Ω source
Main Bus (L-R-C-M) Output Noise	-82dBu (32 channels routed w/faders down, House Master fader at unity)
Aux Bus Output Noise	-90dBu (Aux sends down, Aux Master fader at unity)
Matrix Output Noise	-85dBu (Sends down, Matrix Level at unity)
Crosstalk (measured at 1KHz)	
Channel Mute	>100dB
Channel Fader Attenuation	>100dB
Channel Routing	>80dB
Channel Pan Isolation	>80dB
Channel to Channel Isolation	>90dB
Aux Send Attenuation	>90dB
Aux Pan Isolation	>70dB
Input / Output Impedances	
Channel XLR Input	>3KΩ Balanced (with or without Pad)
Channel Line Input (via TRS)	>20KΩ Balanced
Channel Line Input (via XLR w/Pad)	>4KΩ Balanced
Channel TRS Direct Out	100Ω Impedance Balanced
Bus XLR Outputs (Main, Aux, Matrix)	100Ω Balanced (Feed 600Ω or greater)
Channel and Bus Insert Sends>Returns	100Ω Unbalanced / 5KΩ Unbalanced (C/T Models) 100Ω Balanced / 10KΩ Balanced (Ci/Ti Models) (To Feed 2kΩ or greater)
Monitor TRS Outputs	100Ω Impedance Balanced
Input / Output Levels	
Channel Insert	+4dBu: Tip= Send, Ring= Return, Sleeve= Audio Gnd (C/T Models) Max Out= +22dBu +4dBu: Tip= +, Ring= -, Sleeve= Chassis (Ci/Ti Models) Max Out= +22dBu
Channel Direct Out	+4dBu (TRS Impedance Balanced, Tip= "Hot") Max Out= +22dBu
Balanced Outs	+4dBu (XLR Symmetric Balanced, Pin 2= "Hot") Max Out= +26dBu
Bus Insert	-2dBu: Tip= Send, Ring= Return, Sleeve= Audio Gnd (C/T Models) Max Out= +22dBu -2dBu: Tip= +, Ring= -, Sleeve= Chassis (Ci/Ti Models) Max Out= +22dBu

