

OPERATING INSTRUCTIONS

LD-3 Air Attenuation Compensating Line Driver



**Keep these important operating instructions.
Check www.meyersound.com for updates.**

DECLARATION OF CONFORMITY ACCORDING TO ISO/IEC GUIDE 22 AND EN 45014

Manufacturer's Name:

Meyer Sound Laboratories Inc.

Manufacturer's Address:

2832 San Pablo Avenue
Berkeley, CA 94702-2204, USA

declares that the products

Product Name: LD-3 Line Driver

Product Options: All

conforms to the following Product Specifications

Safety: EN 60065:1998

EMC: EN55103-1: 1997 emission¹
EN55103-2: 1997 immunity²

This device complies with the requirements of the Low Voltage Directive 73 / 23 / EEC and the EMC Directive 89 / 336 / EEC.

This device also complies with EN 55103-1 & -2.

Operation is subject to the following two conditions:

(1) this device may not cause harmful interference, and
(2) this device must accept any interference received, including interference that may cause undesired operation.

Supplementary Information

The product herewith complies with the requirements of the Low Voltage Directive 73/23/EEC and the EMC Directive 89/336/EEC.

Office of Quality Manager
Berkeley, California USA
July 3, 2003

European Contact: Your local Meyer Sound dealer or Meyer Sound Germany, GmbH. Carl Zeiss Strasse 13, 56751 Polch, Germany. Telephone: 49.2654.9600.58 Fax: 49.2654.9600.59

Environmental specifications for Meyer Sound Electronics products

Operating temperature	0°C to +45°C
Non-operating temperature	-40°C to +75°C
Humidity	to 95% at 35°C
Operating altitude	to 4600 m (15,000ft)
Non-operating altitude	to 6300 m (25,000ft)
Shock	30 g 11 msec half-sine on each of 6 sides
Vibration	10 Hz to 55 Hz (0.010 peak-to-peak excursion)

Made by Meyer Sound Laboratories
Berkeley, California USA
European Office:
Meyer Sound Lab. GmbH
Carl Zeiss Strasse 13
56751 Polch, Germany



© 2003 Meyer Sound. All rights reserved.

LD-3 Operating Instructions

The contents of this manual are furnished for informational purposes only, are subject to change without notice, and should not be construed as a commitment by Meyer Sound Laboratories Inc. Meyer Sound assumes no responsibility or liability for any errors or inaccuracies that may appear in this manual. Except as permitted by applicable copyright law, no part of this publication may be reproduced, stored in a retrieval system, or transmitted, in any form or by any means, electronic, mechanical, recording or otherwise, without prior written permission from Meyer Sound.





Meyer Sound, Meyer Sound MAPP Online, SIM and QuickFly are registered trademarks of Meyer Sound Laboratories Inc. (Reg. U.S. Pat. & Tm. Off.). All third-party trademarks mentioned herein are the property of their respective trademark holders.

Printed in the U.S.A.

Part Number: 05.118.040.01 B

SYMBOLS USED

These symbols indicate important safety or operating features in this booklet and on the chassis:

			
Dangerous voltages: risk of electric shock	Important operating instructions	Frame or chassis	Protective earth ground
Pour indiquer les risques résultant de tensions dangereuses	Pour indiquer important instructions	Masse, châssis	Terre de protection
Zu die gefahren von gefährliche spanning zeigen	Zu wichtige betriebsanweisung und unterhaltsanweisung zeigen	Rahmen oder chassis	Die schutzerde
Para indicar voltajes peligrosos.	Instrucciones importantes de funcionamiento y/o mantenimiento	Armadura o chassis	Tierra proteccionista

IMPORTANT SAFETY INSTRUCTIONS

1. Read these instructions.
2. Keep these instructions.
3. Heed all warnings.
4. Follow all instructions.
5. Do not use this apparatus near water.
6. Clean only with dry cloth.
7. Do not block any ventilation openings. Install in accordance with Meyer Sound's installation instructions.
8. Do not install near any heat sources such as radiators, heat registers, stoves, or other apparatus that produce heat.
9. Do not defeat the safety purpose of the grounding-type plug. A grounding-type plug has two blades and a third grounding prong. The third prong is provided for your safety. If the provided plug does not fit into your outlet, consult an electrician for replacement of the obsolete outlet.
10. Protect the power cord from being walked on or pinched particularly at plugs, convenience receptacles, and the point where they exit from the apparatus. The AC mains plug or appliance coupler shall remain readily accessible for operation.
11. Only use attachments/accessories specified by Meyer Sound.
12. Use only with the caster rails or rigging specified by Meyer Sound, or sold with the apparatus. Handles are for carrying only.
13. Unplug this apparatus during lightning storms or when unused for long periods of time.
14. Refer all servicing to qualified service personnel. Servicing is required when the apparatus has been damaged in any way, such as the power-supply cord or plug is damaged, liquid has been spilled or objects have fallen into the apparatus, the apparatus has been exposed to rain or moisture, does not operate normally, or has been dropped.

CONTENTS

INTRODUCTION	1
How to use this manual	1
Introducing The LD-3 Air Attenuation Compensating Line driver	1
CHAPTER 1: AC Power Requirements	3
CHAPTER 2: Audio and System Controls	5
Audio Input	5
Atmospheric Correction	5
Temperature	6
Altitude	6
Relative Humidity	6
Array Correction	6
Array Type	7
Array Size	7
The Enter Button	7
Master Input Channels A and B	8
Channels 1-3 (A and B) Outputs	8
Distance Control	9
Insert Switch	10
Insert Inputs	10
Send Outputs	10
Subs A and B	10
Insert Switch	11
Insert Inputs	11
CHAPTER 3: System Design, Integration, and Optimization	13
Example Design Configurations	13
Meyer Sound MAPP Online®	13
Loudspeaker/Subwoofer Integration	14
SIM® Measurement System	15
Source Independent Measurement Technique	15
Applications	15
Appendix A: Specifications	17
Appendix B: Example Configurations	19
Appendix C: Signal Flow Diagram	22

INTRODUCTION

HOW TO USE THIS MANUAL

As you read this manual, you'll find figures and diagrams to help you understand and visualize what you're reading. You'll also find numerous icons that serve as cues to flag important information or warn you against improper or potentially harmful activities. These icons include:



A **NOTE** identifies an important or useful piece of information relating to the topic under discussion.



A **TIP** offers a helpful tip relevant to the topic at hand.



A **CAUTION** gives notice that an action can have serious consequences and could cause harm to equipment or personnel, delays, or other problems.

INTRODUCING THE LD-3 AIR ATTENUATION COMPENSATING LINE DRIVER

Once a challenge to line array system design, environmental conditions are just another part of the mix with the eight-channel LD-3 (Figure i.1), a powerful tool from Meyer Sound for optimizing large-scale sound reinforcement systems by correcting frequency response for the attenuation of sound in air.



Figure i.1. LD-3 line driver, front and rear panels

Feed the day's weather report into the LD-3 through its Atmospheric Correction and Relative Humidity knobs, dial-in the type of loudspeakers and distance of the throw for each section of the array, and the LD-3 goes to work. A RISC microcontroller retrieves response correction coefficients and corrects the output to compensate for the air absorption for those weather conditions.

By utilizing multiple-variable atmospheric loss equations and pre-calculated Meyer Sound MAPP Online® (for more information, see Chapter 3) stored values, the LD-3 delivers results quickly and efficiently. Its high-quality, digitally-controlled analog filters provide the best of both worlds: the low latency and wide dynamic range of analog and the nimble, precise, repeatable results of digital. The LD-3 corrects frequency response up to 16 kHz at a resolution down to 1 dB.

Figures i.2, i.3, and i.4 are example frequency attenuation curves for three different temperatures with a fixed distance of 100 meters, at seven values for relative humidity. Depending on the atmospheric conditions and the distance the array is throwing, the number of possible correction combinations is staggering – and achievable with the LD-3.

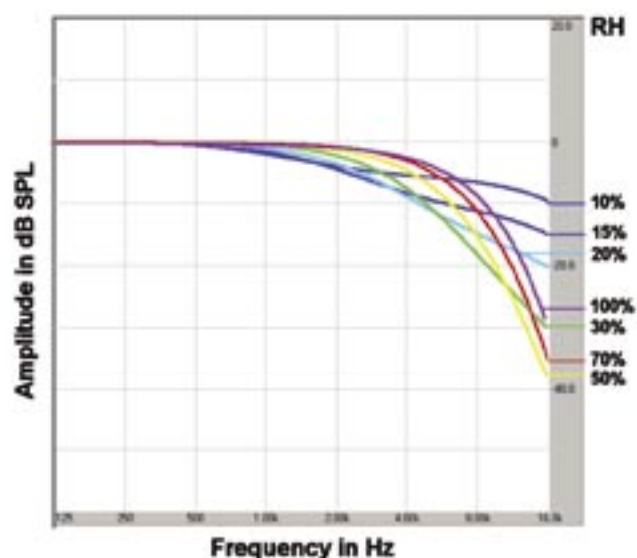

Figure i.2. Air absorption for 10 degrees C at 100 meters

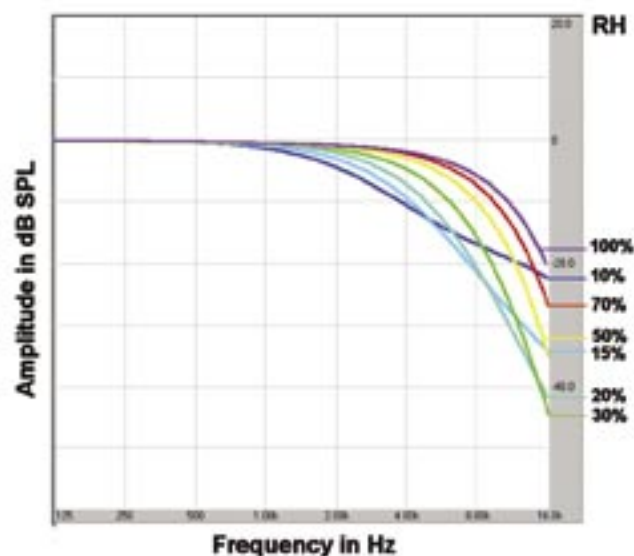

Figure i.3. Air absorption for 20 degrees C at 100 meters

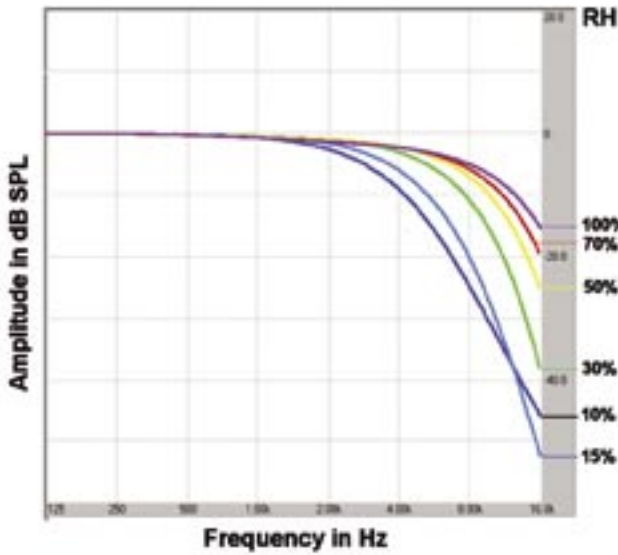

Figure i.4. Air absorption for 30 degrees C at 100 meters

In addition to weather correction, the LD-3's unique ability to compensate for low to mid-low frequency build-up allows the user to fine-tune each channel driving an M Series array. Set the type of loudspeaker being used and the number of cabinets in the array, and the LD-3's stored presets do the rest.

Figure i.5 is an example of a correction made to a MILO array with eight loudspeakers. By applying this correction the result is an incredibly flat system response across a wide range of frequencies.

Each of the LD-3's two master channels consists of a Master Input section, a dedicated subwoofer output, and three outputs to required control. Three Sends and four Insert>Returns provide the control to route the signal and incorporate additional signal processing, such as parametric equalization.

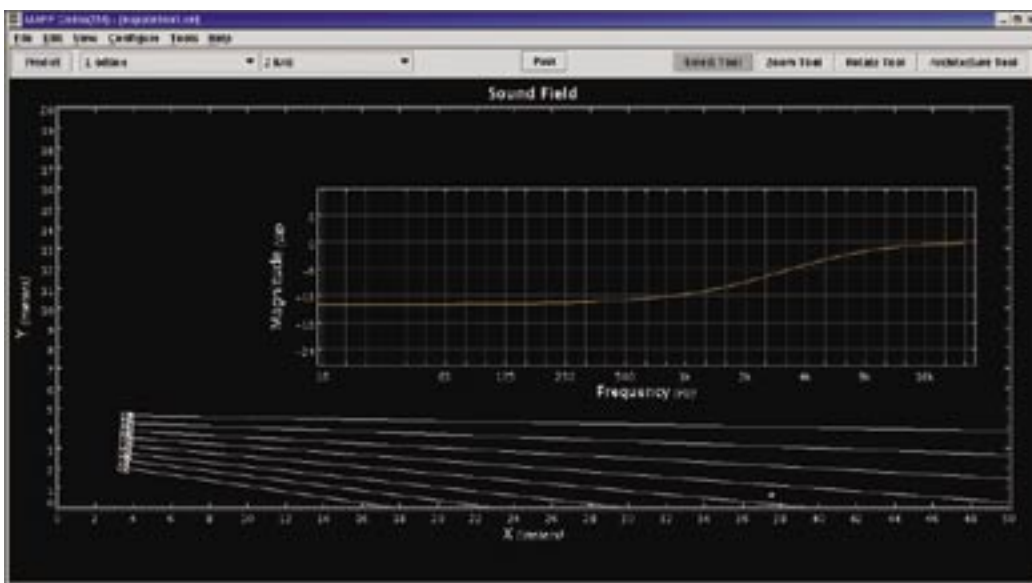

Figure i.5. Correction needed shown with eight MILO loudspeakers at 35 meters

The Master Input section provides individual channel Gain adjustment from -12 to +6 dB, an illuminated Mute switch, Signal/Clip indicator, and a switchable High-Pass Filter (0, 80, or 160 Hz) for boundary correction or optimizing crossover to subwoofers. Master environmental controls include Temperature (0° to 45° C), Altitude (switchable in three ranges: 0-800, 800-2200, and 2200+ m) and Relative Humidity (10 to 100%).

Individual outputs provide Gain trim from -6 to +6 dB, Signal/Clip indicator, an illuminated Mute switch, illuminated Send/Return Insert switches, and Distance controls to define the throw from each sound system branch to its audience coverage area up to 150 meters (492 feet).

The LD-3's dedicated subwoofer control sections feature Polarity switches, Gain trim from -6 to +6 dB, mute, Signal/Clip/Mute indicator, and Send/Return Insert switches. In addition, a high-quality Low-Pass Filter is supplied, switchable to 0, 55, or 80 Hz.

NOTE: While each of the LD-3's output fully independent channels can be used to divide a main system into subsystems, they can also be used to control downfill, front fill, and delay systems, allowing independent signal levels.

In addition to its sophisticated environmental and array control functions, the LD-3 can integrate different types of Meyer Sound self-powered loudspeakers into a cohesive system, while maintaining signal integrity for long cable paths.

The LD-3 occupies two standard 19-inch relay rack spaces. Flash memory for future expansion is built in, and all input and outputs are electronically balanced and utilize XLR (A-3) type connectors. The AC inlet is an IEC standard male connector, protected with a 250 mA 250 V fuse, and switchable in the ranges of 105-125 and 210-250 VAC.

Information and specifications are applicable as of the date of this printing. Updates and supplementary information are posted on the Meyer Sound web site at:

www.meyersound.com

You may contact Meyer Sound Technical Support at:

Tel: +1 510 486.1166

Fax: +1 510 486.8356

Email: techsupport@meyersound.com

CHAPTER 1: AC POWER REQUIREMENTS

The LD-3 uses an international standard IEC 320 mains AC inlet. This convenient rear panel receptacle accepts many power cord types for mains outlets used throughout the world. The LD-3 must have the correct power cord for the AC power in the area in which it will be used.

The LD-3 operates in two AC voltage ranges: 105 – 125 V and 210 – 250 V, at 50 or 60 Hz (Figure 1.1). The voltage select switch on the rear panel must be set to the proper voltage before applying AC power. Connecting the LD-3 to a 225 V AC source with the voltage select switch in the 105 – 125 V position could blow the fuse.

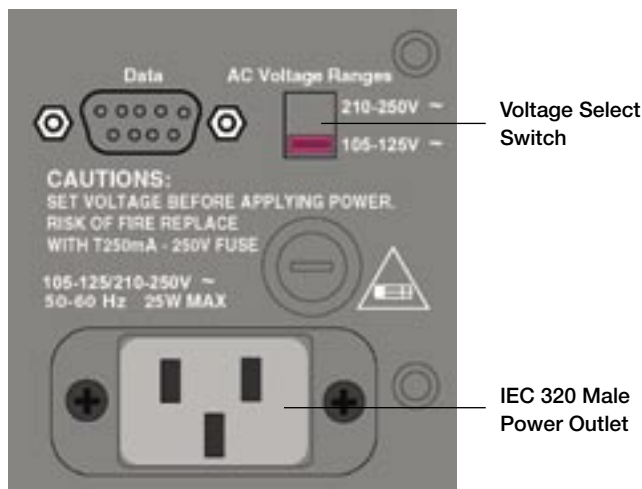
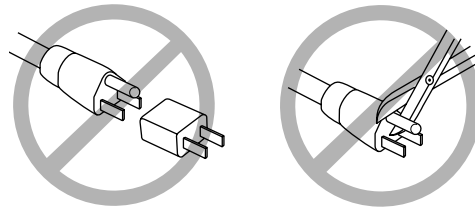

Figure 1.1. Voltage switch and power inlet locations on the LD-3

CAUTION: Always unplug the power cord before changing the voltage select switch.

When the LD-3 is powering on, it takes about two seconds to read stored atmospheric and array correction values, and illuminated *Enter* button (covered in Chapter 3, “Audio and System Controls”) changes from red to green.

Audio outputs are muted internally during normal power on and off, and in case of sudden loss of AC power or unstable line voltage. This precaution prevents noise transmission — and possible damage — to interconnected devices.



CAUTION: Don't use a ground-lifting adapter or cut the AC ground pin. To avoid electrical shock and damage to the unit, use the power cord specified by Meyer Sound or an equivalent that satisfies the requirements of the local safety testing agency.

CAUTION: Do not operate the unit if the power cables are frayed or broken.

Always disconnect the power cord before changing the fuse. To replace the fuse, insert a flat-blade screwdriver in the fuse cap and gently turn counterclockwise; the fuse springs from its socket. Replace only with a 5 x 20 mm, T 250 mA, 250 V, time-lag fuse that conforms to identical safety agency standards. If the fuse blows again, contact Meyer Sound for repair information.

CHAPTER 2: AUDIO AND SYSTEM CONTROLS

Much more than a system integration tool, the LD-3 line driver uses its sophisticated circuitry to bring consistent and predictable results to any M Series line or curvilinear array design. This chapter will help you understand and harness the power of the LD-3's audio and system controls.

AUDIO INPUT

The LD-3 presents a 10 kOhm balanced input impedance to a three-pin XLR connector wired with the following convention:

- Pin 1 — Connected to Earth (AC) ground and chassis through ESD (Electrostatic Discharge) absorption and EMI/RFI (Electromagnetic/Radio Frequency Interference) filters
- Pin 2 — Signal (+)
- Pin 3 — Signal (-)
- Case — Earth (AC) ground and chassis

The LD-3 is balanced in and out, and consequently does not change the polarity unless the “Sub Polarity” switch is engaged on the Sub output section. Pins 2 and 3 carry the input as a differential signal. Use standard audio cables with XLR connectors for balanced signal sources.

The audio input signal should always be applied between pins 2 and 3.



NOTE: All inputs employ ESD absorbers and RF filters.

Pin 1 is connected to the unit's chassis and acts as a safety and current bleed to earth for the ESD and EMI/RFI interference coupled onto the shield of the input cable. Pin 1 is only for bleeding noise to ground, and connecting an audio signal between pins 1 and 2, or pins 1 and 3, results in a noisy audio signal. Most modern balanced audio sources (electronically balanced or transformer output) conform to the wiring convention described above and interface correctly with the LD-3.

ATMOSPHERIC CORRECTION

The LD-3's Atmospheric Correction section (Figure 2.1) uses special atmospheric loss equations and pre-calculated Meyer Sound MAPP Online® stored values from a 2 MB lookup table to correct for key environmental conditions.



Figure 2.1. The Atmospheric Control section is at the heart of the LD-3.

Controls are included for:

- Temperature
- Altitude (atmospheric pressure)
- Relative humidity
- Distance



NOTE: The Distance controls – featuring large green knobs to match the color of the green temperature and relative humidity knobs – are located in sections for individual Channels 1-3 (A and B) outputs, discussed later in this chapter.



NOTE: Atmospheric correction may be disabled per channel on each of the three A and B Output Channels by setting the distance to zero.

Settings are read with 8-bit resolution and a range of coefficient indices are fed to the output channels. The result is corrected frequency response for the attenuation of sound in air up to 16 kHz, with a resolution of approximately 1 dB.

Temperature

The green Temperature control allows you to set temperature in 1° increments from 0° to 45° C. A convenient Fahrenheit (F) to Celsius (c) conversion table is located to the bottom left of the Atmospheric Correction section (Figure 2.2).

Temperature	
F	C
35	2
45	7
55	13
65	18
75	24
85	29
95	35
105	41
115	46
(F-32)/1.8=C	

Figure 2.2. The LD-3 includes a temperature conversion reference table stenciled on its front panel.

Setting temperature is the first step in the atmospheric correction chain; the LD-3 takes the temperature setting and uses it with the other environmental coefficients to find the correction needed across the LD-3's frequency range.

Altitude

The altitude switch supports three ranges:

- 0 to 800 m (0 to 2,624 ft) above sea level
- 800 to 2200 m (2,624 to 7,217 ft) above sea level
- 2200+ m (7,217 ft) above sea level

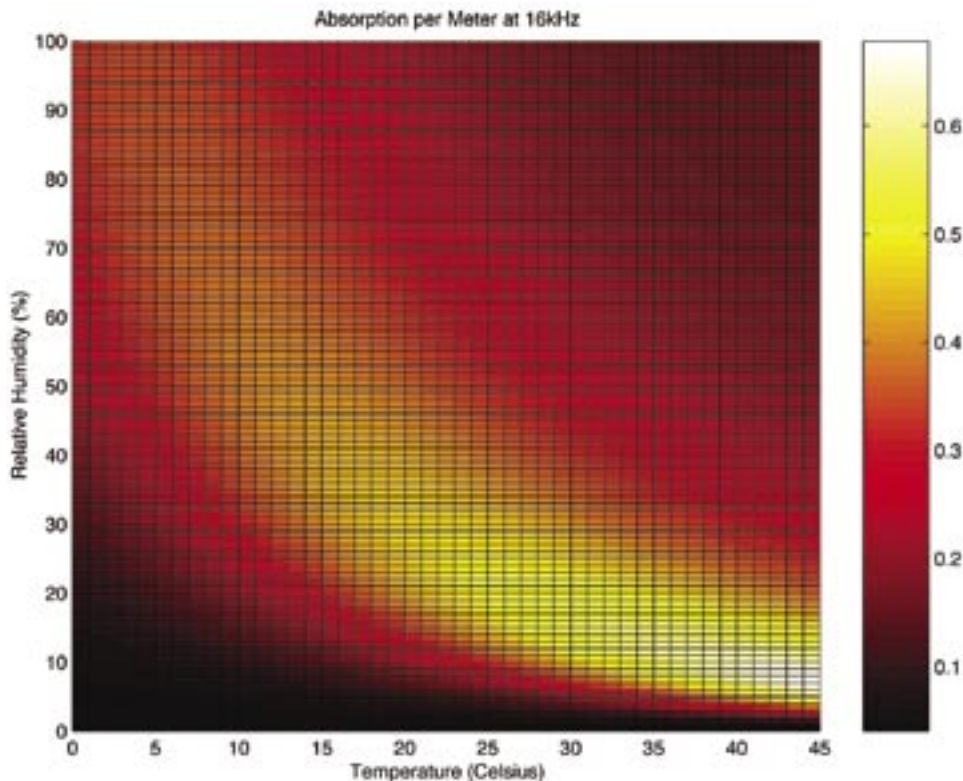

Figure 2.3. Air Absorption per meter at 16 kHz

Setting the altitude notifies the LD-3 of the atmospheric pressure; this setting corresponds to an index into a function which has been pre-solved; the LD-3 then changes how much output correction is needed due to different atmospheric pressure levels.

Relative Humidity

The green Relative Humidity control allows the user to dial-in relative humidity from 10 to 100% in increments from 1 to 5% (the incremental range increases as humidity increases).

The effect of humidity on the attenuation of sound is perhaps the most critical aspect of the LD-3's environmental functionality, and is a fascinatingly complex topic all to itself (and well beyond the scope of this guide). Although it's generally true that the LD-3 will boost frequencies (particularly high frequencies) at an increasing rate as temperature and altitude go up, the effects of humidity are more complex, with few observable ranges that show a consistent, incremental increase.

For instance, at 16 kHz and temperatures above 25° C, a critical range is roughly 10-30% humidity. As shown in Figure 2.3, the higher the humidity in this range, the less air attenuation at that frequency – drier air needs less boost (not a completely intuitive notion in any case).

However, at other humidities (not to mention other temperatures, altitudes and distances) outside of this example range, the rate and pattern of attenuation behaves in other, less intuitive ways.

Because the LD-3's atmospheric control functions are logarithmic rather than exponential (unlike simple filters, for example), they will not always behave in ways you expect "normal" circuitry to behave. For instance, turning the Relative Humidity knob to right doesn't mean that the LD-3 is necessarily adding more correction (it could be adding less).

ARRAY CORRECTION

The LD-3's unique ability to correct the overall frequency response of the line or curvilinear array itself enables you to further fine-tune your system design to correct natural array behavior, such as low frequency build-up.

The Array Correction section (Figure 2.4), lets you set the type of M Series loudspeaker using the Array Type selector switch and the number of cabinets in the array with the Array Size control.



Figure 2.4. The LD-3's Array Correction section

Array Type

The gray Array Type selector (the top knob in the Array Correction section) is a switch that controls the assignment of the LD-3's Array Correction function to any of the following M Series loudspeakers:

- M1D ultra-compact curvilinear array loudspeaker
- M2D compact curvilinear array loudspeaker
- MILO high-power curvilinear array loudspeaker
- M3D line array loudspeaker

The *Remote* setting of the Array Type selector (bottom right side) is for establishing a data link with MAPP Online and downloading a pre-calculated array correction into the LD-3.



TIP: Setting the selector to Remote disables the Array Size selector (covered in the next section).

After loading data via the LD-3's serial Data Port, the Program Loaded LED light, located just below the Remote setting, illuminates.



CAUTION: An unlabeled notch – reserved for future use – exists between the M3D and Remote settings on the Array Type selector. Setting the selector to this notch disables Array Correction functionality.



NOTE: The firmware and ROM (Read Only Memory) which support the LD-3's array correction functions are upgradeable in the field. Contact Meyer Sound or visit the Meyer Sound Web site at www.meyersound.com for more information on when this feature and upgrades will be available.

Array Size

You can set the number of cabinets in your array – up to 24 loudspeakers per channel – using the gray Array Size control. For example, if you have two MILO arrays (typically a left and right array) of 12 cabinets each, you would set the Array Size selector to 12.



NOTE: Setting the Array Size selector to 1 disables Array Correction functionality.

Array correction is also applied to the Sub outputs, and, when active, attenuates the Sub outputs. The Sub section's Gain trim, from –6 to +6 dB, should be used if additional Gain on the Sub outputs is needed.

THE ENTER BUTTON

When the controls in the Atmospheric and Array Correction sections are adjusted, press the illuminated Enter button (Figure 2.5) to enable the changes.

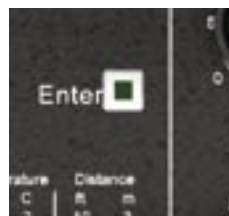

Figure 2.5. The Enter button

Use the Enter button each time a change is made for the following LD-3 functions:

- Temperature
- Altitude
- Relative humidity
- Distance (in any channel)
- Array Type
- Array Size

The Enter button changes from green to red once a change is made on any of the above controls, indicating that it needs to be pressed to update your changes; when the Enter button is pressed, the LD-3 registers the change(s) and the Enter button changes back to green.

For example, if the Temperature is set to 25° and the Relative Humidity to 40%, press Enter, then change the Temperature to 30°; press Enter again for the LD-3 to register the new temperature.

MASTER INPUT CHANNELS A AND B

Master input channels A and B (Figure 2.6) are equipped to control a full-range main system.



Figure 2.6. Master input channels A and B

Each Master Input channel has an illuminated mute switch, signal/clip LED indicator, a switchable high pass filter, and gain. For each channel, the controls perform these functions:

- The gain control sets the overall level from -12 to +6 dB.
- The illuminated Mute switch mutes all channel outputs, which flash red when muted.

NOTE: When muting a master channel, you are effectively muting the individual output circuits located for each sub-channel. Hence each output channel Mute switch will flash red, but its Signal/Clip LED will still be active.

- The bi-colored Signal/Clip LED indicates input signal presence and level with a variable intensity green color, and clipping with flashing red.
- The High Pass Filter switch filters the input signal at 0, 80, or 160 Hz for boundary correction or optimizing crossover to subwoofers. The filter affects Channels 1-3 for each Master Input channel A and B.

NOTE: The High-Pass Filter set to 160 is identical to setting the “Lo-cut” filter on the LD-1A and LD-2 line drivers; it is a 2nd Order (12 dB/octave) at 162 Hz with a Q of 1.82. The 80 Hz filter is an elliptical filter with fast initial attenuation – without the phase shift associated with filters of higher order.

These filters are used to optimize integration with subwoofers; in several cases they can augment an array’s headroom by filtering low frequencies out.

NOTE: When driving loudspeakers with high-pass filters and/or subwoofers with low-pass filters engaged, phase shift caused by the filters in the region where frequencies overlap may require that you change subwoofer polarity – even if they are co-planar or near each other.

CHANNELS 1-3 (A AND B) OUTPUTS

Six individual output channels – three for each Master Input channel – provide Gain trim, illuminated Mute switches, Signal/Clip indicators, and Insert switches (Figure 2.7). In addition, individual distance controls define the throw from each sound system branch to its audience coverage area up to 150 meters.

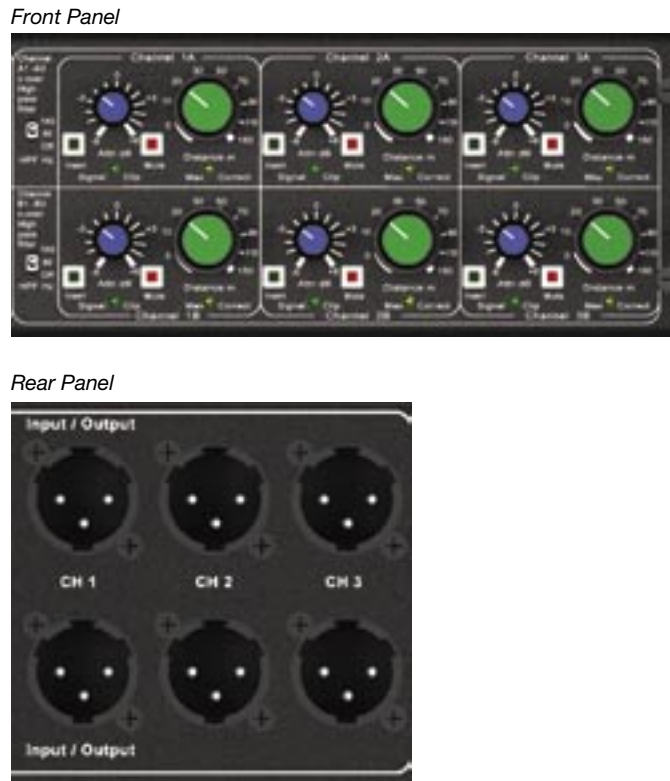

Figure 2.7. The LD-3’s output channel section

For each channel, the controls perform these functions:

- The Gain control sets the output level from -6 to +6 dB.
- The illuminated Mute switch mutes the channel, flashing red when muted.
- The bi-colored Signal/Clip LED indicates signal presence and level with a variable intensity green color, and clipping with flashing red.

NOTE: Although the LD-3 offers a large gain range (-6 to +6 dB) for each output, gain tapering is not recommended for arrays. Adjusting zones with an overall amplitude control for each zone results in the following:

1. Directionality decreases.
2. Low-frequency headroom decreases.
3. The length of the line or curvilinear array column is effectively shortened.

Distance	ft	m
10	3	
70	21	
130	40	
190	58	
250	76	
310	94	
370	113	
430	131	
490	149	
1100	3048	m

Figure 2.8. The LD-3 includes an easy distance conversion reference table stenciled on its front panel.

Distance Control

The green Distance control allows you dial-in the throw from the array on each output channel, from 0 to 150 meters.

NOTE: Setting distance to 0 meters bypasses the atmospheric correction functions.

Setting the Distance enables the LD-3 to adjust the correction curve according to the throw of the loudspeakers on each channel. This setting corresponds to coefficients (in increments from 2 to 10, increasing as distance increases) which provide just the right amount and shape of correction as a function of the other atmospheric variables (Temperature, Altitude, and Relative Humidity). As suggested by Figure 2.9, there are a multitude of correction scenarios for even a handful of distances.

A convenient feet (ft) to meters (m) conversion table is located to the bottom left of the Atmospheric Correction section (Figure 2.8).

NOTE: After dialing in a new distance for any channel, press the Enter button.

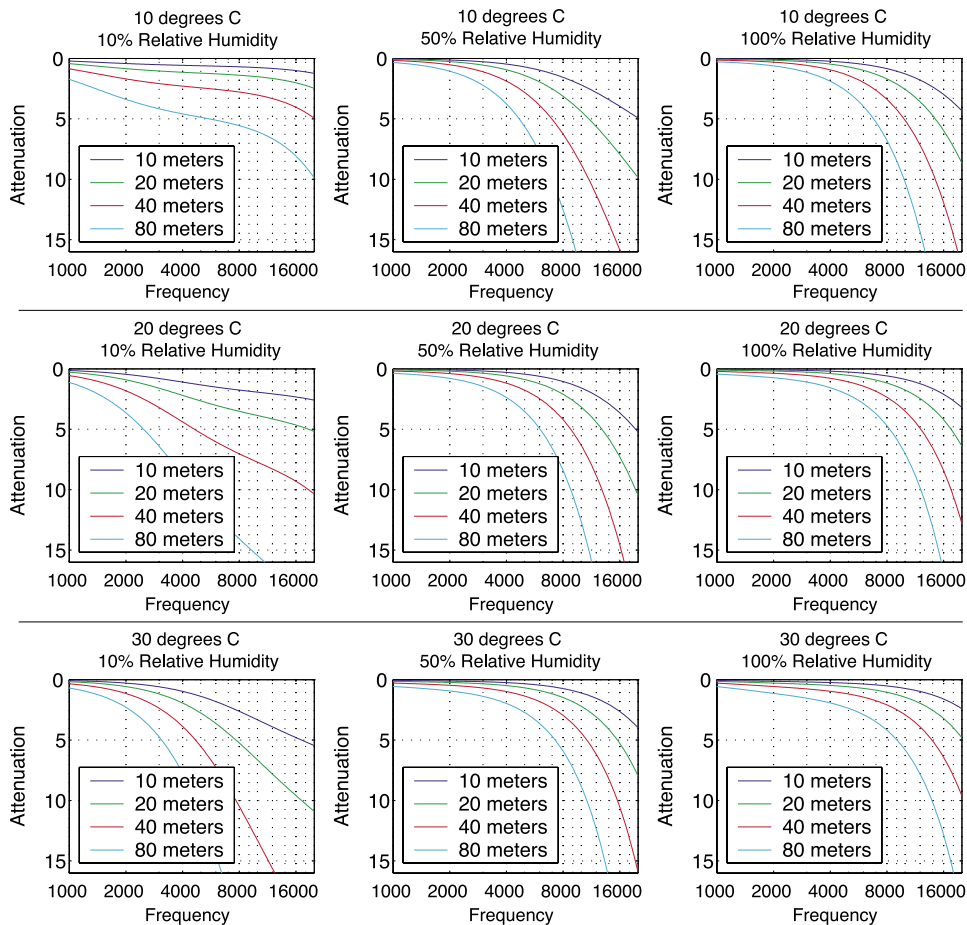

Figure 2.9. Sample atmospheric correction curves for the attenuation of sound in air at 10, 20, 40 and 80 meters.

Once the correction changes are enabled, press the Enter button and the LD-3 changes how much correction is needed due to the throw of your M Series line or curvilinear array on the channel.

Insert Switch

Each output channel utilizes an Insert switch which allows you to add outboard signal processing such as parametric equalization. Figure 2.10 shows the Insert/Return Inputs, as well as the auxiliary output section (Sends), with a Meyer Sound CP-10 complementary phase parametric equalizer.

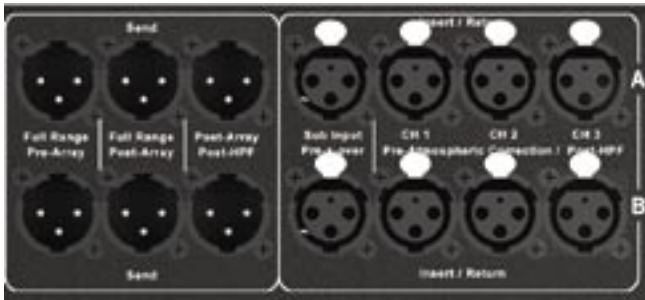

Figure 2.10. The LD-3's back panel showing Sends and Returns for 1-3, A & B; a CP-10 can be added to the signal processing chain



CAUTION: The LD-3's insert inputs are not normalized; if the Insert switch is depressed with nothing connected, the channel will be effectively muted.

Insert Inputs

The Insert/Returns — one for each Channel 1-3 (A and B) — inputs are not affected by the setting of the High-Pass Filter (pre-HPF) but are affected by the settings of the Atmospheric Correction (post-atmospheric correction).

Send Outputs

The LD-3 features three Sends that are straightforward and are derived from three different places before the atmospheric correction (pre-atmospheric) in the signal path:

- Full Range Pre-Array –The output signal is sent to your outboard equipment without any array correction and no filtering.
- Full Range Post-Array – The output signal is sent to your outboard equipment with full array correction and no filtering.
- Post-Array Post-HPF – The output signal is sent to your outboard equipment with full array correction with the high pass filter for the master channel (A or B) on.

SUBS A AND B

Two subwoofer control sections (Figure 2.11) feature Polarity switches, Gain trim, illuminated Mute switches, Signal/Clip indicators, and Insert switches to accommodate outboard signal processing such as parametric equalization and/or delay.

Front Panel



Rear Panel



Figure 2.11. The LD-3's sub section

For each of the two Sub channels, these controls perform the following functions:

- The Gain control sets the output level from -6 to $+6$ dB.
- The illuminated Mute switch mutes the channel, flashing red when muted.
- The bi-colored Signal/Clip LED indicates signal presence and level with a variable intensity green color, and clipping with flashing red.
- The blue illuminated Polarity switch allows you to change polarity where as needed, according to the subwoofer you're using and its interaction with the primary line or curvilinear array(s) in your design.
- The Low Pass Filter switch employs a smooth, high-quality elliptical filter at 55 or 80 Hz; the filter can be disabled by flipping the switch to "Off."

Insert Switch

Each Sub channel utilizes an Insert switch (Figure 2.12) which, when engaged, is useful for driving a sub with a different send or output from a console, or other outboard equipment, if desired.



Figure 2.12. The LD-3's Sub inserts



CAUTION: The Sub section's Insert inputs are not normalized; if the Insert switch is depressed with nothing connected, the channel will be effectively muted.

Insert Inputs

The Insert>Returns are not affected by the array correction, but are affected by the Low-Pass Filter. The Sub section's inserts have a summing stage. If not engaged, the LD-3 will sum the signal from the main input with the signal from the Insert input. This can be useful for making a mono sum left and right channels to drive the subs mono from the main inputs.

CHAPTER 3: SYSTEM DESIGN, INTEGRATION, AND OPTIMIZATION

The LD-3 opens up a number of design and integration scenarios. Its versatility, in conjunction with different M Series loudspeakers and/or subwoofers, gives you the freedom to not only plan for the atmospheric conditions and optimized the array, but to hone the design through quantitative Meyer Sound tools and software. This chapter will take you through some example configurations and introduce you to some real-world options for achieving your design quickly and efficiently.

EXAMPLE DESIGN CONFIGURATIONS

The multiple input, output, insert/returns, and sends on the LD-3 makes the unit very versatile; it can accommodate a number of configurations to satisfy a wide number of applications. See Appendix B for three example configurations that demonstrate the flexibility and utility of the LD-3.

MEYER SOUND MAPP ONLINE

To quantitatively plan your system design, Meyer Sound provides MAPP Online (Figure 3.1), a powerful, cross-platform, Java-based application for accurately predicting the coverage pattern, frequency response, impulse response, and maximum SPL output of single or arrayed Meyer Sound loudspeakers.

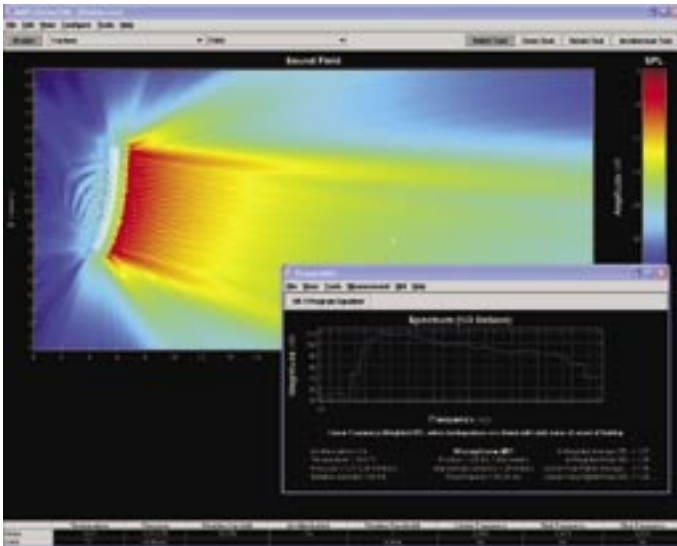



Figure 3.1. MAPP Online is an intuitive, powerful system design tool.

Residing on your computer, MAPP Online facilitates configuring arrays of a wide variety of Meyer Sound products and, optionally, defines the environment in which they will operate, including air temperature, pressure, and humidity, as well as the location and composition of walls.

You can find MAPP Online at:

www.meyersound.com/products/software/mapponline

 **NOTE:** In order to use MAPP Online, you will need to register by clicking “Apply for MAPP Online” on the Web page listed above. After registration and upon approval, an e-mail will be sent to you with a username and password along with the address for the Web page where you can download MAPP Online. Online instructions will guide you through the download and setup process.

As its name indicates, MAPP Online is an online application: when a prediction is requested, data is sent over the Internet to a high-powered server at Meyer Sound that runs a sophisticated acoustical prediction algorithm using high-resolution, complex (magnitude and phase) polar data. Predicted responses are returned over the Internet and displayed on your computer in color.

With MAPP Online, you can:

- Plan an entire portable or fixed loudspeaker system and determine delay settings for fill loudspeakers.
- Clearly see interactions among loudspeakers and minimize destructive interference.
- Place microphones anywhere in the sound field and predict the frequency response, impulse response, and sound pressure level at the microphone position using MAPP Online’s Virtual SIM feature.
- Refine your system design to provide the best coverage of the intended audience area.
- Use a virtual VX-1 program equalizer to predetermine the correct control settings for best system response.
- Gain valuable load information about the array to determine rigging capacities.

MAPP Online enables you to come to an installation prepared with a wealth of information that ensures the system will satisfy your requirements “out of the box” – including basic system delay and equalization settings. Its accurate, high-resolution predictions eliminate unexpected onsite adjustments and coverage problems. With MAPP Online, every sound system installation has a maximum chance of success.

MAPP Online is compatible with Windows, Linux, Unix, and Apple Macintosh computers running Mac OS X version 10.1.2 or higher. The MAPP Online Web page above lists additional system requirements and recommendations.

LOUDSPEAKER/SUBWOOFER INTEGRATION

Using the LD-3's filters helps to easily integrate and optimize your M Series arrays with subwoofers. High-pass filters augment array headroom by removing frequencies near the low end of the loudspeaker's operating range, while low-pass filters can remove unwanted mid-low frequencies reproduced by the subwoofers.



NOTE: Full-range signals may be applied to Meyer Sound's self-powered loudspeakers and subwoofers because they have built-in active crossovers. However, the use of external filters – like the ones in the LD-3 – is optional, and should be used very carefully to avoid phase shifts that can cause cancellations or dips in the response.

The use of these filters reduces areas of overlap and minimizes the interaction and possible cancellations between subsystems, usually resulting in highly desirable behavior, such as very flat frequency response. As shown in Tables 3.1 through 3.8, some of the loudspeaker and subwoofer combinations you can implement using the LD-3's filtering capabilities can go a long way toward fine-tuning your system.

All data in Tables 3.1 through 3.8 are based on designs in a close-proximity, coplanar orientation, at a **2:1 ratio** of loudspeakers to subwoofers. Out of all possible combinations, these yield the flattest frequency response.

Table 3.1: MILO and M3D-Sub

HPF	LPF	∅ Reverse Switch	Result
80	80	Engaged	Flat response
80	Off	Engaged	Flat response
160	Off	Engaged	Very flat response
Off	Off	Off	Boost in the 80 Hz region

Table 3.2: MILO and 650-P (650-P set to pin 2 positive)

HPF	LPF	∅ Reverse Switch	Result
Off	Off	Engaged	Boost in the 100 Hz region
160	Off	Engaged	Very flat response
80	80	Off	Very flat response
160	80	Off	Flat response

Table 3.3: M3D and M3D-Sub

HPF	LPF	∅ Reverse Switch	Result
Off	Off	Off	Flat response
80	Off	Off	Very flat response, +3 dB sub gain recommended

Table 3.4: M3D and 650-P

HPF	LPF	∅ Reverse Switch	Result
Off	Off	Engaged	Flat response
Off	55	Engaged	Flat response
80	55	Off	Very flat response, +6 dB sub gain recommended
160	80	Off	Very flat response, +6 dB sub gain recommended

Table 3.5: M2D and M2D-Sub

HPF	LPF	∅ Reverse Switch	Result
Off	Off	Off	Very flat response
80	Off	Off	Very flat response, +3 dB sub gain recommended
80	80	Engaged	Very flat response, +3 dB sub gain recommended

Table 3.6: M2D and 650-P (650-P set to pin 2 positive)

HPF	LPF	∅ Reverse Switch	Result
Off	55	Off	Flat response, -6 dB sub gain recommended*
80	80	Engaged	Very flat response, -6 dB sub gain recommended*

* Unlike the matched sensitivity of the M2D and M2D-Sub, the 650-P is +6 dB more sensitive than the M2D/M2D-Sub.

Table 3.7: M1D and M1D-Sub

HPF	LPF	∅ Reverse Switch	Result
Off	Off	Off	Very flat response
80	80	Engaged	Flat response, +3 dB sub gain recommended

Table 3.8: M1D and USW-1P

HPF	LPF	∅ Reverse Switch	Result
Off	55	Off	Flat response, -6 dB sub gain recommended*
80	80	Engaged	Very flat response, -6 dB sub gain recommended*



NOTE: When loudspeakers and subwoofers are physically separated by more than 4 feet – or delay must be used between them – a measurement system such as SIM (covered in the next section) should be used to determine the correct delay and polarity.

SIM® MEASUREMENT SYSTEM

Meyer Sound also offers a self-contained design and troubleshooting package: the SIM Measurement System. SIM is a measurement and instrumentation system including a selection of hardware and software options, microphones and accessory cables. SIM is optimized for making audio frequency measurements of an acoustical system with a resolution of up to $1/24^{\text{th}}$ of an octave; the high resolution enables you to apply precise electronic corrections to adjust system response using frequency and phase (time) domain information.

Source Independent Measurement Technique

SIM implements the Meyer Sound source independent measurement technique, a dual-channel method that accommodates statistically unpredictable excitation signals. Any excitation signal that encompasses the frequency range of interest (even intermittently) may be used to obtain highly accurate measurements of acoustical or electronic systems. For example, concert halls and loudspeaker systems may be characterized during a musical performance using the program as the test signal, allowing you to:

- View measurement data as amplitude versus time (impulse response) or amplitude and phase versus frequency (frequency response)
- Utilize a single-channel spectrum mode
- View frequency domain data with a logarithmic frequency axis
- Determine and internally compensate for propagation delays using SIM Delay Finder function

Applications

The main application of SIM is loudspeaker system testing and alignment. This includes:

- Measuring propagation delay between the subsystems to set correct polarities and set very precise delay times
- Measuring variations in frequency response caused by the acoustical environment and the placement and interaction of the loudspeakers to set corrective equalization
- Optimizing subwoofer integration
- Optimizing loudspeaker arrays

SIM can also be used in the following applications:

- Microphone calibration and equalization
- Architectural acoustics
- Transducer evaluation and correction
- Echo detection and analysis
- Vibration analysis
- Underwater acoustics

APPENDIX A

LD-3 Line Driver Specifications

ATMOSPHERIC CORRECTION (Affects Output Channels 1-3, both A & B)	
Temperature	0 to 45° Celsius
Relative Humidity	10 to 100% RH
Altitude	3 position switch: 0 to 800, 800 to 2200, 2200 and up
Distance	See "Outputs: Channels 1-3 (A&B)"
ARRAY CORRECTION	
Type	M1D, M2D, MILO, M3D, upgradable Remote Setting
Array Size	1 to 24 Elements in the array (If set to 1 element, bypasses array correction)
MASTER INPUTS	
Attenuation Control	-12 to +6 dB
Mute	Master mute, controls output mutes
OUTPUTS: SUB OUT	
Attenuation Control	-6 to +6 dB
Mute	Mutes at the output stage
Polarity Switch	Toggles the polarity of the sub output
Low-Pass Filter/crossover	3 position switch: OFF, 55 Hz and 80 Hz
Insert Switch	When switch is "in" it disconnects Master signal from Sub signal path and allows only Sub Insert/Return XLR to drive Sub signal path. When switch is "out" the Master signal and Sub Insert XLR are summed onto the Sub signal path. Master signal is muted if switch is "in" and no signal is present at Sub Insert. Sends and Inserts operate 3dB lower than Master signal, therefore signals applied to Sub Insert XLR will have 3 dB greater gain through LD-3.
Signal/Clip Indicator	Glows green with signal and red when output is in clipping
OUTPUTS: CHANNELS 1-3 (A&B)	
High-Pass Filter/Crossover	3 position switch: OFF, 80 Hz and 160 Hz. Affects all 3 channel outputs
Attenuation Control	-6 to +6 dB (-6 to -3 and +3 to +6 settings not recommended to preserve array behavior)
Distance	1 to 150 m; works in conjunction with the Atmospheric Correction section (If set to 0 m, bypasses atmospheric correction)
Mute	Mutes at the output stage
Insert Switch	Toggles the input from Master to Insert/Return. Not normalized, mutes channel when engaged if no signal is present at Insert/Return.
Signal/Clip Indicator	Glows green with signal and red when output is in clipping
Maximum Correction Indicator	Glows when the correction has reached 16 dB
AUDIO INPUTS	
Type	Differential balanced input circuit
Impedance	10 k Ω differential (between pins 2 and 3)
Wiring	Pin 1: chassis/earth ground; Pin 2: signal (+); Pin 3: signal (-)
RF Filter	Common Mode: 425 kHz low-pass; Differential Mode: 142 kHz low-pass
Common Mode Rejection Ratio	> 80 dB (typically 90 dB); measured in the range 50 Hz - 1 kHz
Signal Presence	LED (Variable intensity; monitored at the input for each channel)
	Threshold: -26 dBV (50 mV rms) pink noise or sinewave
	Full Intensity: -10 dBV (300 mV rms) pink noise or sinewave

INPUT CONNECTORS	
Master A & B	2 Female XLR; 1 per input channel
<i>Insert/Return</i>	
Sub Input	2 Female XLR; 1 per input channel
Channels 1-3 (A&B)	6 Female XLR; 1 per input channel; Insert is Pre-Atmospheric Correction / Post-High Pass Filter/Crossover
AUDIO OUTPUTS	
Type	Balanced, cross-coupled simulated transformer topology
Impedance	50 Ω balanced (between pins 2 and 3)
RF Filter	Pins 2 and 3 shunted to chassis via 500 pF capacitance
Wiring	Pin 1: chassis/earth ground; Pin 2: signal; Pin 3: signal
DRIVE CAPABILITY	
Maximum Voltage	600 Ω Load: ± 17.8 V pk (+22 dBV, +24.2 dBu sinewave) No Load: ± 19 V pk (+22.5 dBV, +24.7 dBu sinewave) NOTE: 0 dBV = 1 V rms; 0 dBu = 0.775 V rms; 0 dBm = 1 mW rms.
Maximum Current	± 70 mA pk (10 V rms into 200 Ω)
Cables and Load	> 100,000 pF (> 1000 ft cable) without instability or distortion
OUTPUT CONNECTORS	
Sub Output	2 Male XLR; 1 per output channel
Channels 1-3 (A&B)	6 Female XLR; 1 per output channel
<i>Send Outputs</i>	
Full Range Pre	2 Male XLR; 1 per output channel; Send is Pre-Array, Pre-Atmospheric correction
Full Range Post	2 Male XLR; 1 per output channel; Send is Post-Array, Post-Atmospheric correction
Post Array and HPF	2 Male XLR; 1 per output channel; Send is Post-Array, Post-Atmospheric correction and Post High Pass filter/Crossover
AUDIO PERFORMANCE	
Frequency Response	< ± 0.2 dB 20 Hz - 20 kHz (All corrections disabled)
Dynamic Range	> 110 dB NOTE: Ratio of maximum sinewave to A-weighted noise floor.
Noise Floor	> -90 dB V A-weighted; > -88 dB V un-weighted NOTE: Level set to unity gain (0 dB).
THD	< 0.02% (typically 0.005%)
Gain Accuracy	< ± 0.15 dB at +6 dB gain; < ± 0.25 dB at 0 dB gain
Mute Attenuation	> 88 dB
AC POWER	
Connector	IEC 320 (line, neutral/line, earth)
Operating Voltage	105 - 125 V AC, 210 - 250 V AC (selectable with rear panel switch); 50/60 Hz
Maximum Power	25 W; Fuse: 5 x 20 mm, T 250 mA, 250 V, time-lag

APPENDIX B

Example Configurations

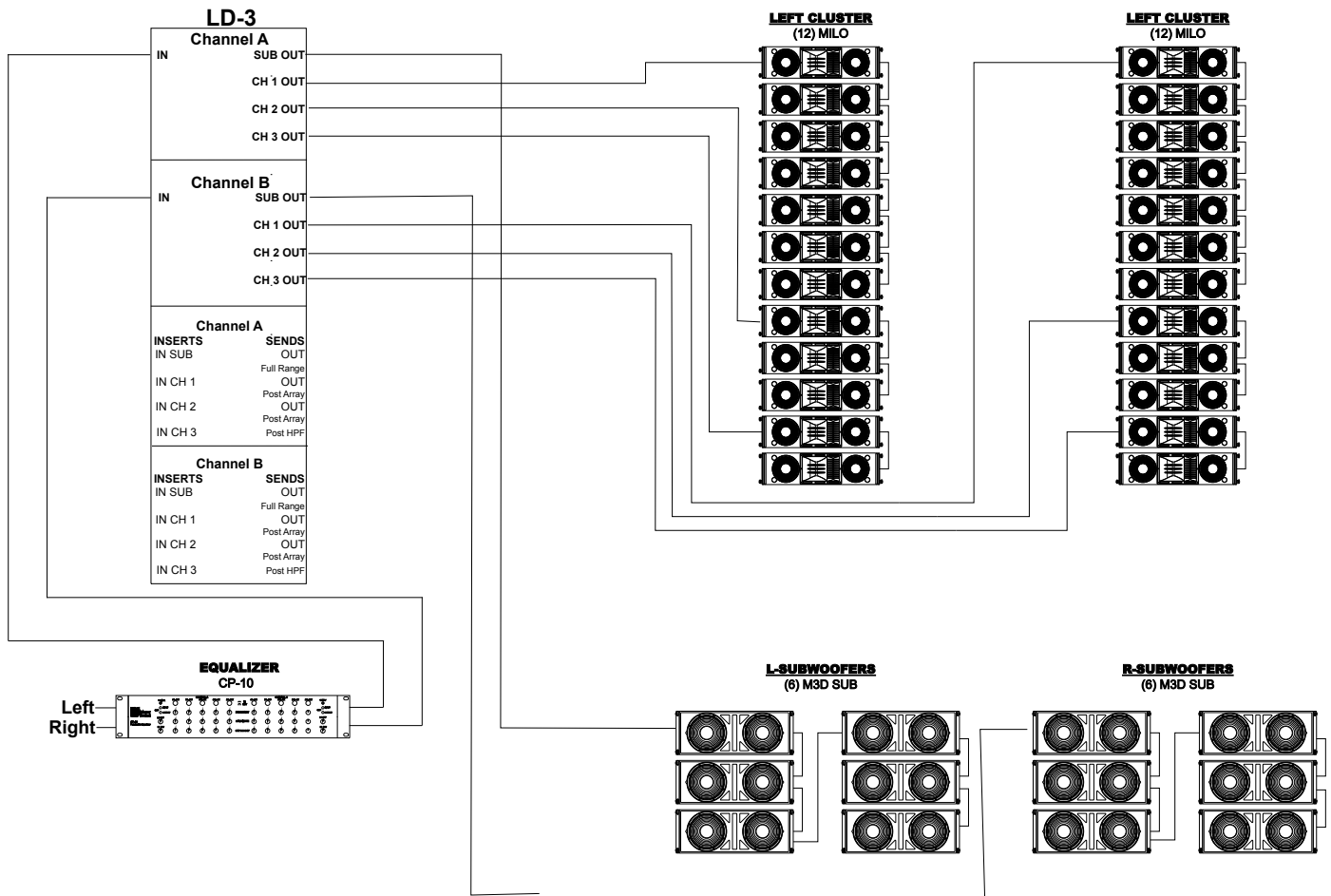

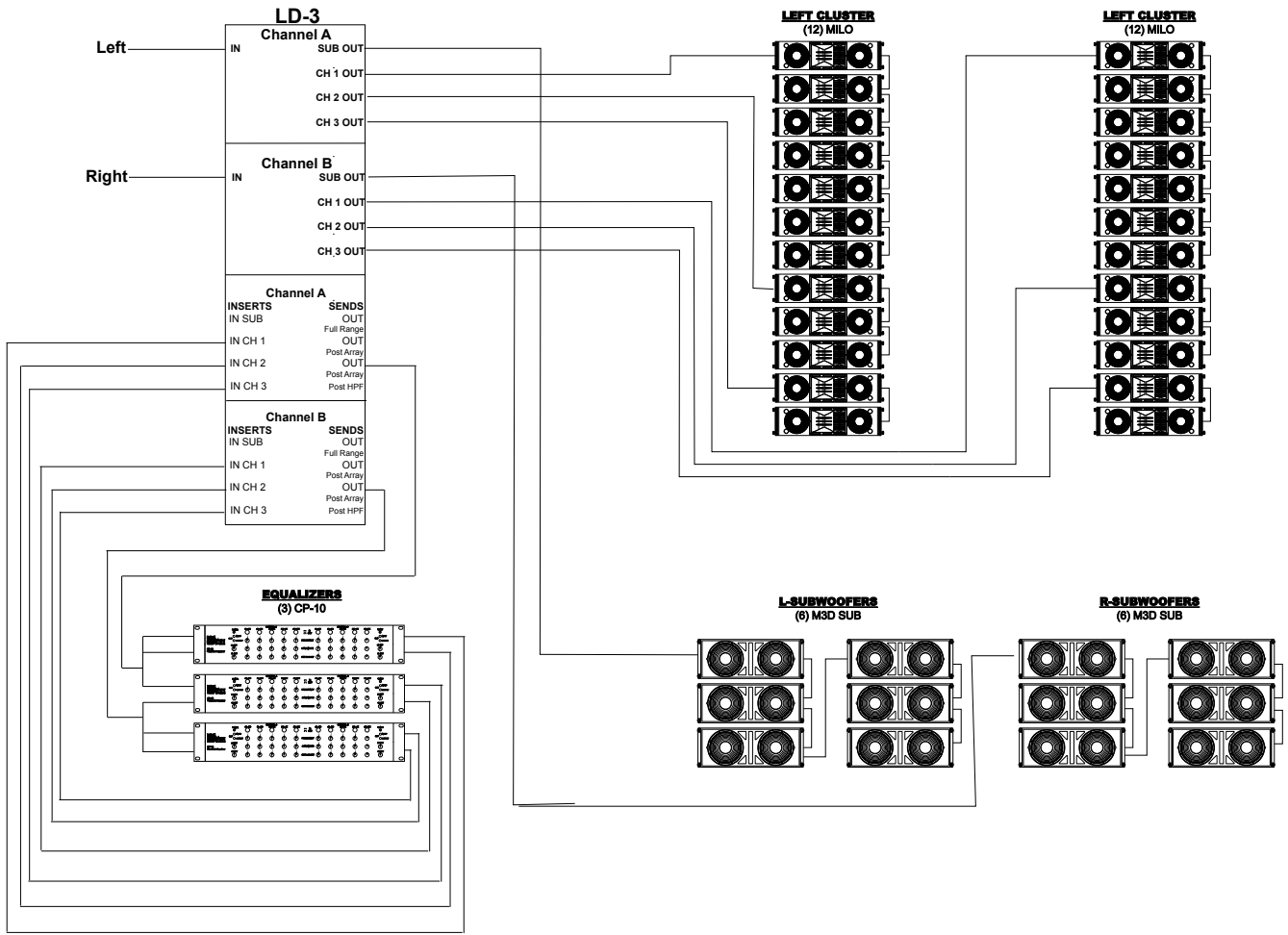

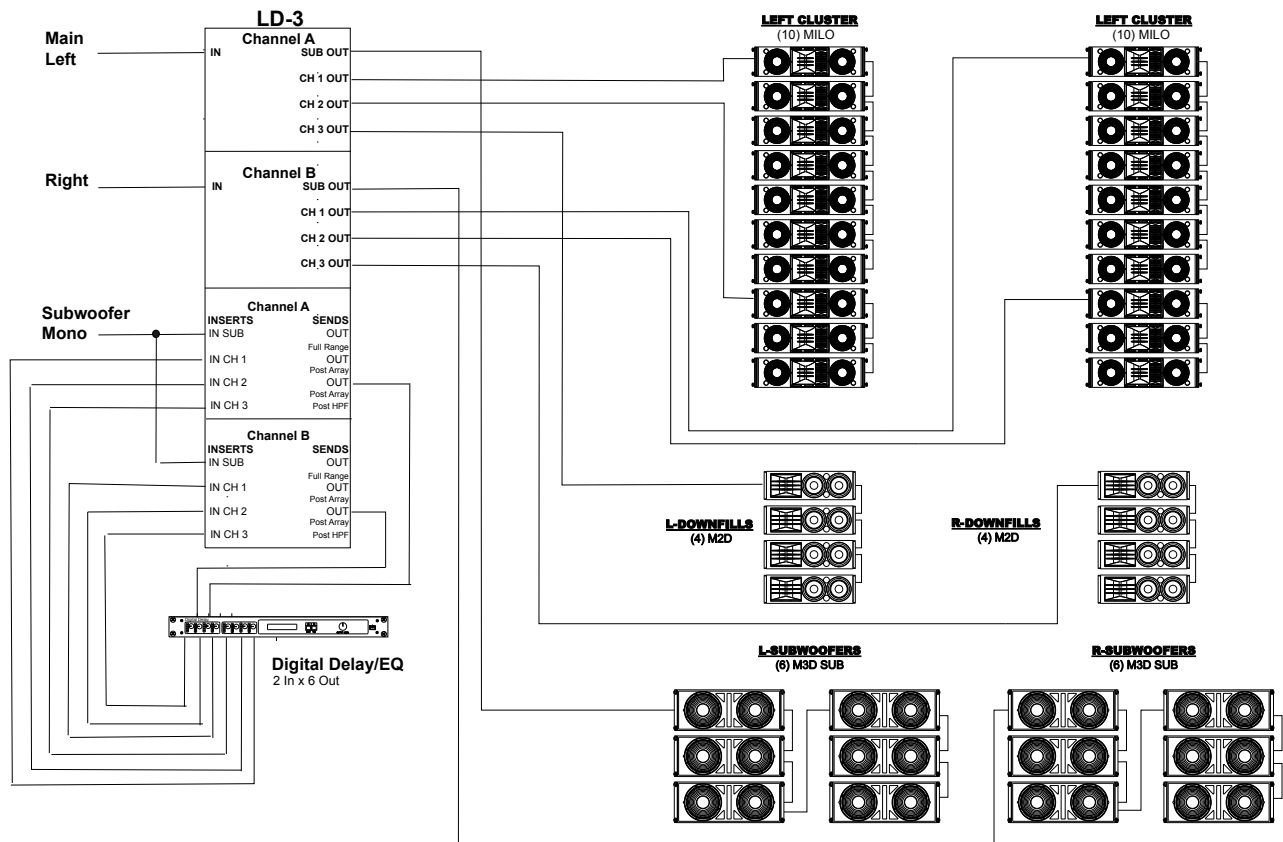

APPENDIX C

LD-3 Signal Flow Diagram

