



# M32 DIGITAL CONSOLE

Digital Console for Live and Studio with 40 Input Channels,  
32 MIDAS Microphone Preamplifiers and 25 Mix Buses

User Manual





# Table of Contents

<b>Precautions</b> .....	<b>4</b>
<b>Introduction</b> .....	<b>5</b>
<b>1. Control Surface</b> .....	<b>6</b>
1.1 Channel Strip - Input Channels .....	6
1.2 Channel Strip - Group/Bus Channels .....	7
1.3 Config/Preamp .....	8
1.4 Gate.....	8
1.5 Dynamics .....	9
1.6 Equaliser .....	9
1.7 Bus Sends.....	10
1.8 Main Bus.....	11
1.9 RECORDER .....	11
1.10 Main Display (Summary) .....	12
1.11 Monitor .....	13
1.12 Talkback.....	15
1.13 Show Control .....	16
1.14 Assign .....	18
1.15 Mute Groups.....	19
<b>2. Main Display</b> .....	<b>20</b>
2.1 Main Display - Top Section .....	20
2.2 Meters.....	24
2.3 Routing.....	25
2.4 Setup .....	28
2.5 Library.....	31
2.6 Effects .....	32
2.7 Mute Group .....	33
2.8 Utility.....	33
2.9 Internal Effects.....	34
<b>3. Rear Panel</b> .....	<b>44</b>
3.1 MONITOR / CONTROL ROOM OUT .....	44
3.2 AC / POWER .....	44
3.3 XLR OUT 1-16.....	44
3.4 XLR IN 1-32 .....	44
3.5 KLARK TEKNIK DN32-USB .....	44
3.6 REMOTE CONTROL.....	44
3.7 MIDI .....	45
3.8 AES / EBU OUT .....	45
3.9 ULTRANET .....	45
3.10 AES50 .....	45
3.11 AUX IN / OUT.....	45
<b>4. Appendices</b> .....	<b>46</b>
4.1 Appendix A: Technical Specifications.....	46
4.2 Appendix B: MIDI Operation .....	48
4.3 Appendix C: Dimensions .....	50
4.4 Appendix D: Block Diagram.....	52
4.5 Appendix E: Service Information .....	53
4.6 Appendix F: Glossary.....	54

## EN Important Safety Instructions





 Terminals marked with this symbol carry electrical current of sufficient magnitude to constitute risk of electric shock. Use only high-quality commercially-available speaker cables with plugs pre-installed. All other installation or modification should be performed only by qualified personnel.

 This symbol, wherever it appears, alerts you to the presence of uninsulated dangerous voltage inside the enclosure - voltage that may be sufficient to constitute a risk of shock.

 This symbol, wherever it appears, alerts you to important operating and maintenance instructions in the accompanying literature. Please read the manual.

 **Caution**  
To reduce the risk of electric shock, do not remove the top cover (or the rear section). No user serviceable parts inside. Refer servicing to qualified personnel.

 **Caution**  
To reduce the risk of fire or electric shock, do not expose this appliance to rain and moisture. The apparatus shall not be exposed to dripping or splashing liquids and no objects filled with liquids, such as vases, shall be placed on the apparatus.

 **Caution**  
These service instructions are for use by qualified service personnel only. To reduce the risk of electric shock do not perform any servicing other than that contained in the operation instructions. Repairs have to be performed by qualified service personnel.

1. Read these instructions.
2. Keep these instructions.
3. Heed all warnings.
4. Follow all instructions.
5. Do not use this apparatus near water.
6. Clean only with dry cloth.
7. Do not block any ventilation openings. Install in accordance with the manufacturer's instructions.
8. Do not install near any heat sources such as radiators, heat registers, stoves, or other apparatus (including amplifiers) that produce heat.

9. Do not defeat the safety purpose of the polarized or grounding-type plug. A polarized plug has two blades with one wider than the other. A grounding-type plug has two blades and a third grounding prong. The wide blade or the third prong are provided for your safety. If the provided plug does not fit into your outlet, consult an electrician for replacement of the obsolete outlet.

10. Protect the power cord from being walked on or pinched particularly at plugs, convenience receptacles, and the point where they exit from the apparatus.

11. Use only attachments/accessories specified by the manufacturer.



injury from tip-over.

13. Unplug this apparatus during lightning storms or when unused for long periods of time.

14. Refer all servicing to qualified service personnel. Servicing is required when the apparatus has been damaged in any way, such as power supply cord or plug is damaged, liquid has been spilled or objects have fallen into the apparatus, the apparatus has been exposed to rain or moisture, does not operate normally, or has been dropped.

15. The apparatus shall be connected to a MAINS socket outlet with a protective earthing connection.

16. Where the MAINS plug or an appliance coupler is used as the disconnect device, the disconnect device shall remain readily operable.



17. Correct disposal of this product: This symbol indicates that this product must not be disposed of with household waste, according to the WEEE Directive (2012/19/EU) and your national law. This product should be taken to a collection center licensed for the recycling of waste electrical and electronic equipment (EEE). The mishandling of this type of waste could have a possible negative impact on the environment and human health due to potentially hazardous substances that are generally associated with EEE. At the same time, your cooperation in the correct disposal of this product will contribute to the efficient use of natural resources. For more information about where you can take your waste equipment for recycling, please contact your local city office, or your household waste collection service.

12. Use only with the cart, stand, tripod, bracket, or table specified by the manufacturer, or sold with the apparatus. When a cart is used, use caution when moving the cart/apparatus combination to avoid

## LEGAL DISCLAIMER

MUSIC Group accepts no liability for any loss which may be suffered by any person who relies either wholly or in part upon any description, photograph, or statement contained herein. Technical specifications, appearances and other information are subject to change without notice. All trademarks are the property of their respective owners. MIDAS, KLARK TEKNIK, TURBOSOUND, BEHRINGER, BUGERA and DDA are trademarks or registered trademarks of MUSIC Group IP Ltd. © MUSIC Group IP Ltd. 2014 All rights reserved.

## LIMITED WARRANTY

For the applicable warranty terms and conditions and additional information regarding MUSIC Group's Limited Warranty, please see complete details online at [music-group.com/warranty](http://music-group.com/warranty).

## Precautions

**Before installing, setting up or operating this equipment make sure you have read and fully understand all of this section and the 'IMPORTANT SAFETY INSTRUCTIONS' at the front of this manual.**

This equipment is supplied by a mains voltage that can cause electric shock injury!

The following must be observed in order to maintain safety and electromagnetic compatibility (EMC) performance.

### Safety warnings

Signal 0V is connected internally to the chassis.

To completely isolate this equipment from the AC mains, while observing full safety precautions (see 'Power' on page xiii), switch off the isolator switch (above the mains power sockets on rear of control centre) and then switch off the mains at the three mains outlets. Unplug the three mains leads from the rear of the control centre. For details of how to remove Volex locking type plug, see 'Power' below.

To avoid electrical shock do not remove covers.

### General precautions

In the event of ground loop problems, disconnect the signal screen at one end of the connecting cables. Note that this can only be done when the equipment is used within a balanced system.

Do not remove, hide or deface any warnings or cautions.

### Power

The system power supplies contain LETHAL VOLTAGES greatly in excess of the mains voltage and its rails can produce extremely large currents that could burn out equipment and wiring if shorted.

The internal power supplies are of the switch mode type that automatically sense the incoming mains voltage and will work where the nominal voltage is in the range 100 VAC to 240 VAC.

Each mains inlet is to be sourced from its own separate wall-mounted mains outlet socket.

Otherwise, their mains sources must be suitably distributed so as to meet local safety regulations.

A Volex locking type plug is fitted on each supplied mains cable, which plugs into a mains IEC connector on the unit. When fitted properly the Volex plug locks into place, preventing it from working loose, or being inadvertently knocked loose or pulled out. To fit a Volex plug, insert it into the mains IEC connector and push it in until it locks in place. Then, check to make sure it is locked in place. To remove it, release its locking device and then pull it out. When fitting or removing a Volex plug, always hold the plug itself and never use the cable, as this may damage it.

During operation, a minimum of two of its three mains inlets must be connected and supplying power.

When removing the equipment's electric plugs from the outlets, always hold the plug itself and not the cable. Pulling out the plug by the cable can damage it.

Never insert or remove an electric plug with wet hands.

*Do not* connect/disconnect a mains power connector to/from the M32 Control Centre while power is being applied to it. Switch the power off first.

Before switching the M32 Control Centre on or off, make sure that all monitor loudspeaker power amplifiers are turned off or muted.

### Handling the equipment

Completely isolate the equipment electrically and disconnect all cables from the equipment before moving it.

When lifting or moving the equipment, always take its size and weight into consideration. Use suitable lifting equipment or transporting gear, or sufficient additional personnel.

Do not insert your fingers or hands in any gaps or openings on the equipment, for example, vents.

Do not press or rub on the sensitive surface of the GUI screens.

If the glass of the GUI screen is broken, liquid crystals shouldn't leak through the break due to the surface tension of the thin layer and the type of construction of the LCD panel. However, in the unlikely event that you do make contact with this substance, wash it out with soap.

### Installation

Before installing the equipment:

Make sure the equipment is correctly connected to the protective earth conductor of the mains voltage supply of the system installation through the mains leads

Power to the equipment must be via a fused spur(s)

Power plugs must be inserted in socket outlets provided with protective earth contacts. The electrical supply at the socket outlets must provide appropriate over-current protection

Both the mains supply and the quality of earthing must be adequate for the equipment

Before connecting up the equipment, check that the mains power supply voltage rating corresponds with the local mains power supply. The rating of the mains power supply voltage is printed on the equipment.

### Location

Ideally a cool area is preferred, away from power distribution equipment or other potential sources of interference.

Do not install the equipment in places of poor ventilation.

Do not install this equipment in a location subjected to excessive heat, dust or mechanical vibration. Allow for adequate ventilation around the equipment, making sure that its fans and vents are not obstructed. Whenever possible, keep the equipment out of direct sunlight.

Do not place the equipment in an unstable condition where it might accidentally fall over.

Make sure that the mains voltage and fuse rating information of the equipment will be visible after installation.

**Ensure that all underside vents are left clear during operation.**

## Audio connections

To ensure the correct and reliable operation of your equipment, only high quality, balanced, screened, twisted pair audio cable should be used.

XLR connector shells should be of metal construction so that they provide a screen when connected to the control centre and, where appropriate, they should have Pin 1 connected to the cable screen.



### Electrostatic discharge (ESD) precautions

Observe full electrostatic discharge (ESD) — also known as ‘anti-static’ — precautions when carrying out procedures in this manual that are accompanied by the ESD Susceptibility Symbol (shown above). This caution symbol shows you that ESD damage may be caused to items unless proper ESD precautions are taken, which include the following practices:

- Keep the work area free from plastic, vinyl or styrofoam
- Wear an anti-static wrist strap
- Discharge personal static before handling devices
- Ground the work surface
- Avoid touching ESD-sensitive devices.

### Radio frequency interference—Class A device

This equipment has been tested and found to comply with the limits for a Class A digital device, pursuant to Part 15 of the FCC Rules.

These limits are designed to provide reasonable protection against harmful interference when the equipment is operated in a commercial environment. This equipment generates, uses, and can radiate radio frequency energy and, if not installed and used in accordance with the instruction manual, may cause harmful interference to radio communications.

Operation of this equipment in a residential area is likely to cause harmful interference in which case the user will be required to correct the interference at his own expense.

### Electric fields

#### Caution:

**In accordance with Part 15 of the FCC Rules & Regulations, “... changes or modifications not expressly approved by the party responsible for compliance could void the user’s authority to operate the equipment.”**

Should this product be used in an electromagnetic field that is amplitude modulated by an audio frequency signal (20 Hz to 20 kHz), the signal to noise ratio may be degraded. Degradation of up to 60 dB at a frequency corresponding to the modulation signal may be experienced under extreme conditions (3 V/m, 90% modulation).

### Safety equipment

Never remove, for example, covers, housings or any other safety guards. Do not operate the equipment or any of its parts if safety guards are ineffective or their effectiveness has been reduced.

### Optional equipment

Unless advised otherwise, optional equipment must only be installed by service personnel and in accordance with the appropriate assembly and usage regulations.

### Special accessories

To comply with part 15 of the FCC Rules, any special accessories (that is, items that cannot be readily obtained from multiple retail outlets) supplied with this equipment must be used with this equipment; do not use any alternatives as they may not fulfil the RF requirement.

## Introduction

Welcome to the M32 Digital Console User manual! After years of intense development, we are proud to offer a mixer that combines tremendous power and flexibility with a very user-friendly layout and intuitive workflow that allows you to get up and running right away.

The M32 combines a control surface with streamlined workflow, extensive I/O and signal processing into a compact desktop form factor. Employing award-winning MIDAS PRO Series microphone preamplifiers and the custom-designed MIDAS PRO motorised faders that are rated for one million cycles, along with a daylight-viewable TFT screen, the control surface is designed to allow immediate access to critical functions with total and automatic recall of settings. Extensive onboard I/O includes 40 A/D and 24 D/A Cirrus Logic converters, 96 bi-directional channels over SuperMAC AES50, stereo AES/EBU out, 16 channels of Ultratnet personal monitoring and 32 x 32 channels of recording over USB.

Abundant analogue connectivity is provided by 32 MIDAS PRO Series digitally-controllable microphone preamps, six line-level auxiliary inputs and outputs, 16 XLR outputs, stereo monitoring outs on XLR/TRS and dual phones outputs. Each of the 32 microphone inputs can accept balanced or unbalanced mic- or line-level signals, and include switchable phantom power, 72 dB gain range and maximum +23 dBu level before clip. A separate external microphone input and the internal talkback mic allow communication to various destinations.

Dual AES50 Ethernet jacks that employ KLARK TEKNIK SuperMAC technology contribute 96 x 96 signals to the total count of 168 x 168 accessible sources and destinations. Motorised faders, recallable mic preamps, programmable routing and the ability to save and recall entire scenes make set or programme changes quick and simple. A top panel USB connector enables system data to be stored, or a board mix to be recorded directly to external flash or hard drives.

The Input section is home to 16 high-resolution 100 mm motorised faders, providing control over channels 1-16, 17-32, Aux inputs/USB playback/FX returns. A separate section of eight motorised faders controls DCA groups 1-8, bus masters 1-8 and 9-16, as well as matrices 1-6. The channel editing section provides tangible controls for instant access to the selected channel’s gain, dynamics, EQ and other functions. A custom-assignable section allows certain control functions to be mapped directly to a set of dedicated rotary controls and buttons.

A main seven inch-wide, high-contrast colour display provides information for editing pertinent parameters of the active function or effect. Relevant parameters are quickly recalled to the display for editing via ‘VIEW’ buttons in each subsection. Each channel also features a small, customisable LCD screen for track name, number, colour and source graphic.

A virtual FX rack offers eight true-stereo (16 mono) multi-effects processors, with over 60 effects models that eliminate the need for any additional outboard gear. Four high-quality effects such as delay, chorus and reverb can run concurrently with eight channels of 31-band graphic equalisation.

Transmit up to 32 channels of audio to and from a computer using the KLARK TEKNIK DN32 USB audio interface.

The M32 integrates seamlessly with other M32 consoles, the MIDAS DL16 digital stagebox and the Behringer P-16 personal monitoring system for a complete live, studio and installed sound solution.

Control the mixer from a distance with the free iPad application, or with editing and remote control software connected via Ethernet. The M32’s ease of use, intuitive workflow, diverse feature set and integration with other equipment make it an ideal centrepiece for installed and production sound in any setting.

Continue through this User Manual to learn all about the functionality that this powerful mixer has to offer. We also recommend that you check [midasconsoles.com](http://midasconsoles.com) to make sure you have the latest firmware installed, as we release frequent updates.

# 1. Control Surface

## 1.1 Channel Strip - Input Channels

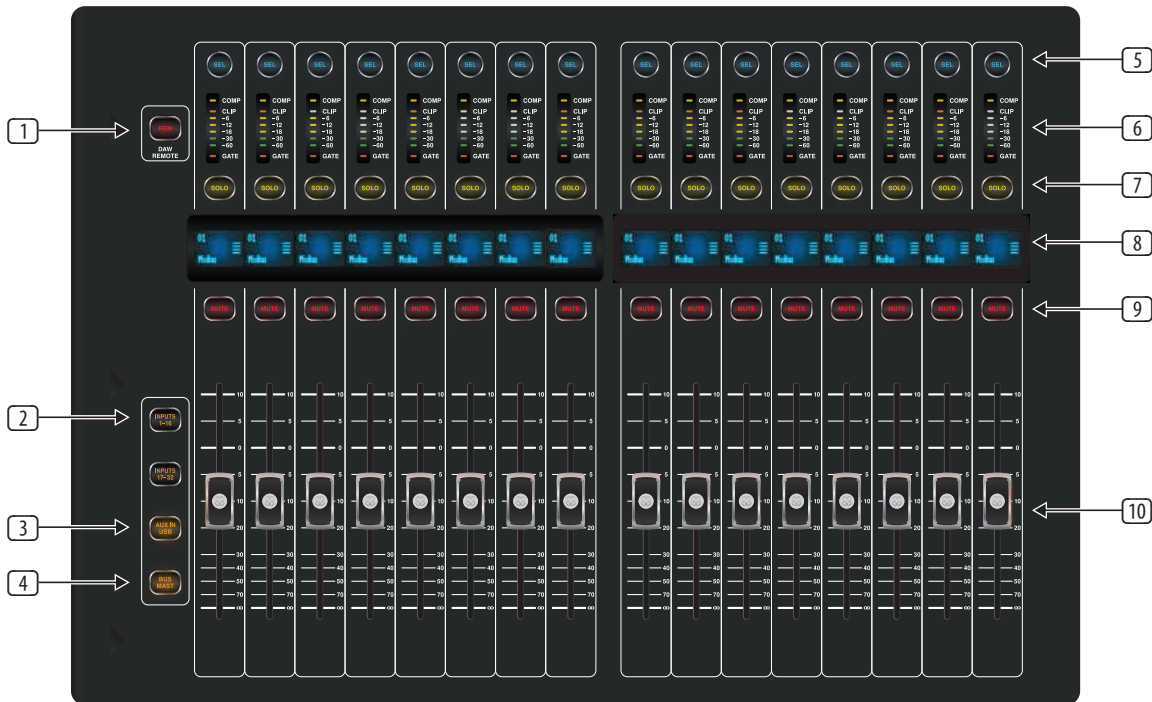

### 1 REM - DAW Remote Button

Press this button to enable remote control of your Digital Audio Workstation software using the Group/Bus fader section controls. This section can emulate HUI or Mackie Control Universal communication with your DAW.

### Layer Select Buttons

#### 2 INPUTS 1-16 / INPUTS 17-32

Pressing one of these buttons selects either the channel 1-16 layer, or the channel 17-32 layer.

#### 3 AUX IN / USB

Press to select the Aux In / USB Recorder and FX 1-4 Returns layer.

#### 4 BUS MAST

Press to bring up all the 16 Bus Master channels.

### Individual Channel Strip Controls

Each of the above layers operates in a similar way by use of the following controls:

#### 5 SEL Button

Press to select an input or bus (depending on which layer is active) and allow it to be edited by the Channel Strip and Main Display.

#### 6 Channel Meter

This displays the signal level of the input or bus, depending on which layer is active. The COMP and GATE LEDs light to indicate that compression and/or noise gate are active.

#### 7 SOLO Button

Press to send the channel to the solo bus.

#### 8 Scribble Strip

Information such as channel number, input source and a graphic icon are displayed here.

#### 9 MUTE Button

Press to mute the channel.

#### 10 Fader

Use the MIDAS PRO Motor Fader to adjust the channel output volume. In Sends on Faders mode channel faders represent the send level from channels to the currently selected output bus (see next page).

## 1.2 Channel Strip - Group/Bus Channels

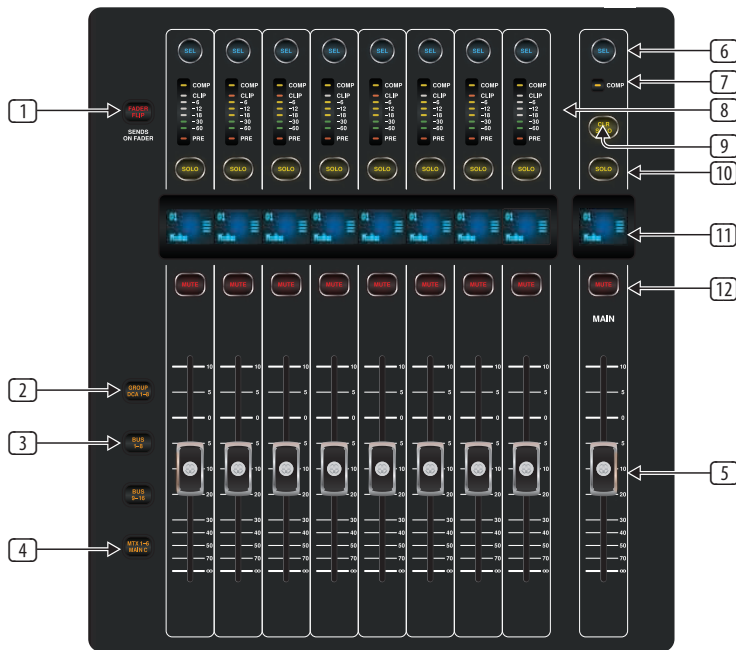

### 1 FADER FLIP - SENDS ON FADER Button

Press to activate the M32's Sends on Fader function. This function aids with the level setting of channels sent to any of the 16 Mix Buses. It is only for channels assigned to Mix Buses 1-16, and does not work for DCA groups, main or matrix buses. The Sends on Fader function works in two convenient ways to cover the most obvious situations in a live environment:

### When preparing a monitor mix for a specified musician

- Select the monitor bus (**BUS 1-8** or **BUS 9-16**) that feeds the musician's stage monitor
- Press the Sends on Fader button, which will then flash
- Select one of the three input channel layers (**INPUTS 1-16**, **INPUTS 17-32**, **AUX IN / USB** or **BUS MAST**)
- As long as **Sends on Fader** is active all faders in the input channels section correspond to the send levels on the selected monitor mix bus.

### When checking or editing where a selected input signal is to be sent

- Select the input channel in the left-hand section
- Press the **Sends on Fader** button, which will then flash
- Select either bus channel layer (**BUS 1-8** or **BUS 9-16**)
- The bus faders now represent the send levels of the selected input channel.

**TIP:** Sends on Fader can also be used for conveniently sending Bus or Main M/C signals to Matrices.

### Layer Select Buttons

#### 2 GROUP DCA 1-8

Press this button to select the Group DCA layer.

A DCA group is a grouping function, made possible by the console's digital operation, where individual input channels can be grouped together and controlled with a single output fader on the right-hand side of the console. Unlike the traditional sub-grouping function found on analogue consoles, a DCA group does not combine the different input channels into a common sub-mix. Instead, the individual input channels still retain their original routing characteristics, but their level adjustments are commonly controlled.

#### 3 BUS 1-8 / 9-16

Press one of these buttons to select either the Bus 1-8 layer or the Bus 9-16 layer.

#### 4 MTX 1-6 / MAIN C

Press to select the Aux In / USB channel layer.

### Individual Channel Strip Controls

Each of the above layers operates in a similar way by use of the following controls:

#### 6 SEL Button

Press to select a DCA or bus (depending on which layer is active) and allow it to be edited by the Channel Strip and Main Display.

#### 8 Channel Meter

This displays the signal level of the DCA or bus, depending on which layer is active. The PRE LED lights to indicate that the bus is sourced pre-fader, while the COMP LED lights to indicate that compression is active.

#### 10 SOLO Button

Press to send the channel to the solo bus.

#### 11 Scribble Strip

Information such as channel number, input source and a graphic icon are displayed here.

#### 12 MUTE Button

Press to mute the channel.

#### 5 Fader

Use the MIDAS PRO Fader to adjust the channel volume or bus sends in Sends on Faders mode. The faders will automatically display the current status as layers and functions are changed.

**Main****6 SEL Button**

Press to select the Main bus for editing.

**7 COMP**

The **COMP** indicator will illuminate when compression is being applied to the stereo output mix.

**9 CLR SOLO Button**

Press to clear all sources assigned to the solo bus.

**10 SOLO Button**

Press to solo the main bus.

**11 Scribble Strip**

Customisable information relating to the main bus are displayed here.

**12 MUTE Button**

Press to mute the main bus.

**5 Fader**

Use the MIDAS PRO Fader to adjust the output of the main bus.

**12 MUTE Button**

Press to mute the main bus.

**5 Fader**

Use the MIDAS PRO Fader to adjust the output of the main bus.

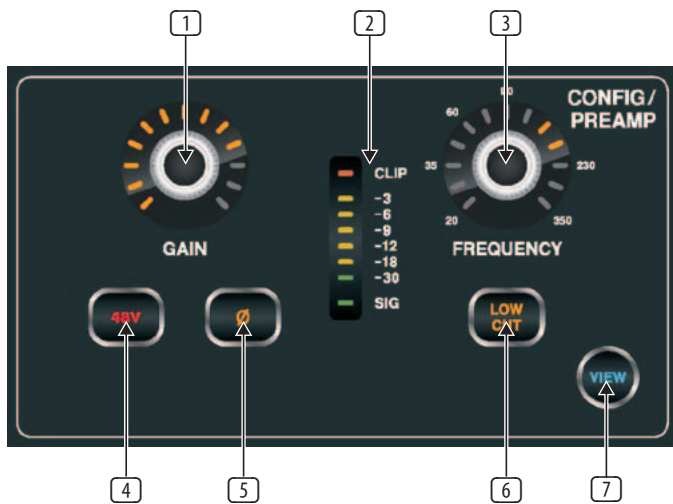
**1.3 Config/Preamp****1 GAIN Rotary Control**

On a microphone preamplifier, input gain varies the amount of amplification applied to the microphone. Adjust the preamp gain for the selected channel with the **GAIN** rotary control.

**2 LED Display**

The LED display in the Config/Preamp section illustrates the signal input level for the selected channel. This is shown as a value between 0 dB and -30 dB. When there is a signal present, but below -30 dB, the **SIG** LED is lit. When the signal exceeds 0 dB the **CLIP** LED illuminates.

Please note that, when pressing the **VIEW** button, the signal input level displayed on the Main Display shows a value of between 0 dB and -60 dB.

**3 FREQUENCY Rotary Control**

The **FREQUENCY** rotary control selects the frequency at which the low cut filter begins to filter unwanted frequencies for the selected channel. The filter is engaged by pressing the **LOW CUT** button (see below).

Please note that the low cut filter is only available for the 32 primary input channels.

**4 48 V**

Phantom power is a method for transmitting DC electric power through microphone cables to operate microphones that contain active electronic circuitry. It is most commonly used with condenser microphones, though many active direct boxes also use it. The technique is also used in other applications where power supply and signal communication take place over the same wires. Press the **48 V** button to apply phantom power on the selected channel's physical input.

**5 Ø**

An audio signal's 'phase' refers to its position in a point of time along the waveform cycle, with each cycle being 360°. Press the **Ø** button to reverse the selected channel's phase by 180°. This can be useful when using the reverse phase function to cancel noise across more than one channel.

**6 LOW CUT**

Press the **LOW CUT** button to engage the low cut filter for the selected channel.

Please note that the low cut filter is only available for the 32 primary input channels.

**7 VIEW**

Press the **VIEW** button to access more detailed parameters on the Main Display. See the section **Main Display - config** for more details.

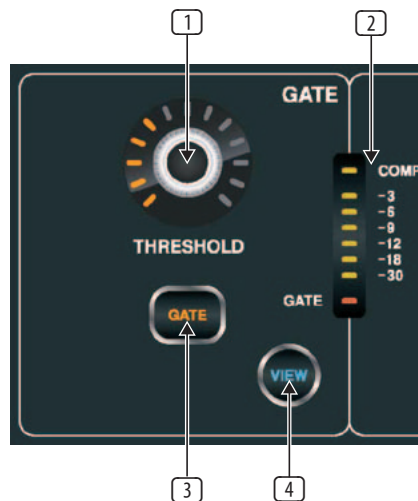
**1.4 Gate****1 THRESHOLD Rotary Control**

A noise gate is a device that is used to control the volume of an audio signal. Often used in conjunction with a compressor (see **DYNAMICS**), which attenuate signals above a certain threshold, noise gates attenuate signals that register below the threshold. By turning the **THRESHOLD** rotary control, the audio level at which the gate affects the signal can be controlled.

**2 LED Display**

The LED display illustrates when the Gate is functioning for the selected channel by illuminating the red **GATE** LED at the bottom of the display.

**3 GATE**

Pressing the **GATE** button engages the noise gate for the selected channel.

**4 VIEW**

Press the **VIEW** button to access more detailed parameters on the Main Display. See the section **Main Display - gate** for more details.



## 1.5 Dynamics



### 1 THRESHOLD Rotary Control

Dynamic Range Compression, or just Compression is a device that is used to control the volume of an audio signal. Often used in conjunction with a noise gate (see GATE), which attenuate signals below a certain threshold, compressors attenuate signals that register above the threshold. By turning the **THRESHOLD** rotary control, the audio level at which the compressor affects the signal can be controlled.

### 2 LED Display

The LED display illustrates when the Dynamics are functioning for the selected channel by illuminating the red **COMP** LED. The level of attenuation that is being applied to the signal is shown as a value between 0 dB and -30 dB.

Please note that, when pressing the **VIEW** button, the attenuation level displayed on the Main Display shows a value of between 0 dB and -60 dB.

### 3 COMP

Pressing the **COMP** button engages the compressor for the selected channel.

### 4 VIEW

Press the **VIEW** button to access more detailed parameters on the Main Display. See the section **Main Display - dyn** for more details.

## 1.6 Equaliser

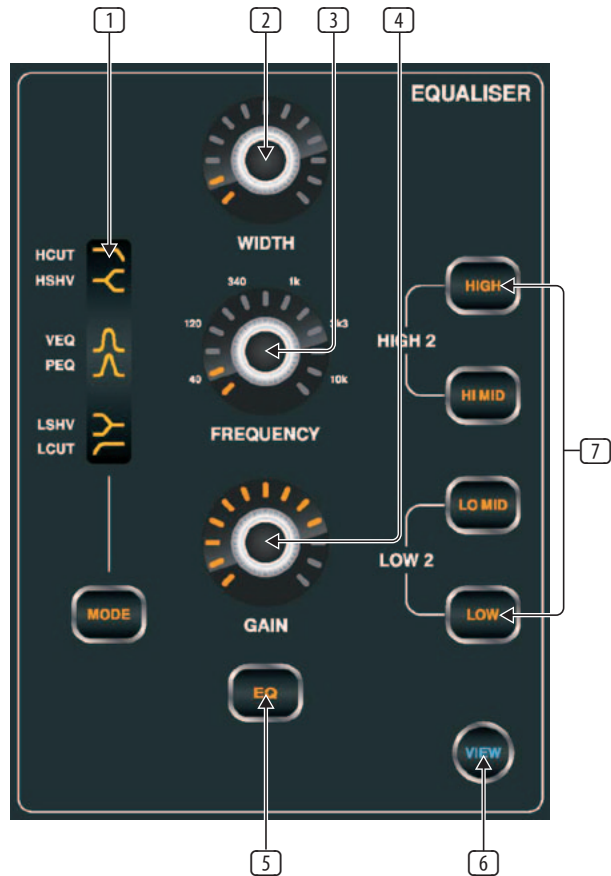

### 1 MODE Select Button and Display

Pressing the **MODE** button cycles through each of the EQ modes for the currently selected frequency range. Each of the modes and the frequency ranges to which they apply are listed below:

#### HCUT

A high-cut function which attenuates signals above the selected frequency.

#### HSHV

A high-shelving function which boosts or attenuates signals above the selected frequency. Only available with the **HIGH 2 - HIGH** setting.

#### VEQ

A bell filter that provides a more 'Vintage EQ' sound. Available on all frequency settings.

#### PEQ

A bell filter that provides a classic 'Parametric EQ' sound. Available on all frequency settings.

#### LSHV

A low-shelving function which boosts or attenuates signals below the selected frequency. Only available with the **LOW 2 - LOW** setting.

#### LCUT

A low-cut function which attenuates signals below the selected frequency.

**NOTE:** Low-Cut and High-Cut Modes do not have Gain and Width settings.

**2 WIDTH Rotary Control**

The **WIDTH** rotary control determines the span of frequencies around that specified by the **FREQUENCY** rotary control, which will be affected by adjusting the **GAIN** control.

**3 FREQUENCY Rotary Control**

Select the specific frequency to be adjusted with the **FREQUENCY** rotary control. Each frequency can be adjusted between 20 Hz and 20 kHz. The equaliser provides four discrete filter bands for input channels and even six discrete bands for buses and matrices as follows:

**7 Individual Band Frequencies****HIGH**

A band intended for high frequencies, with access to **HCUT**, **HSV**, **VEQ** and **PEQ** EQ modes.

**HI MID**

A band intended for high-mid frequencies, with access to **VEQ** and **PEQ** EQ modes.

**LO MID**

A band intended for low-mid frequencies, with access to **VEQ** and **PEQ** EQ modes.

**LOW**

A band intended for low frequencies, with access to **LCUT**, **LSV**, **VEQ** and **PEQ** EQ modes.

**HIGH 2**

Press **HIGH** and **HI MID** concurrently to access the **HIGH 2** band of any bus equaliser.

**LOW 2**

Press **LOW** and **LO MID** concurrently to access the **LOW 2** band of any bus equaliser.

**4 GAIN Rotary Control**

Boost or attenuate the selected frequency by turning the **GAIN** rotary control. The selected equaliser band is inactive when the Gain control is in the centre position (0 dB).

**5 EQ Button**

Engages the EQ function for the selected channel.

**6 VIEW**

Press the **VIEW** button to access more detailed parameters on the Main Display. See the section **Main Display - eq** for more details.

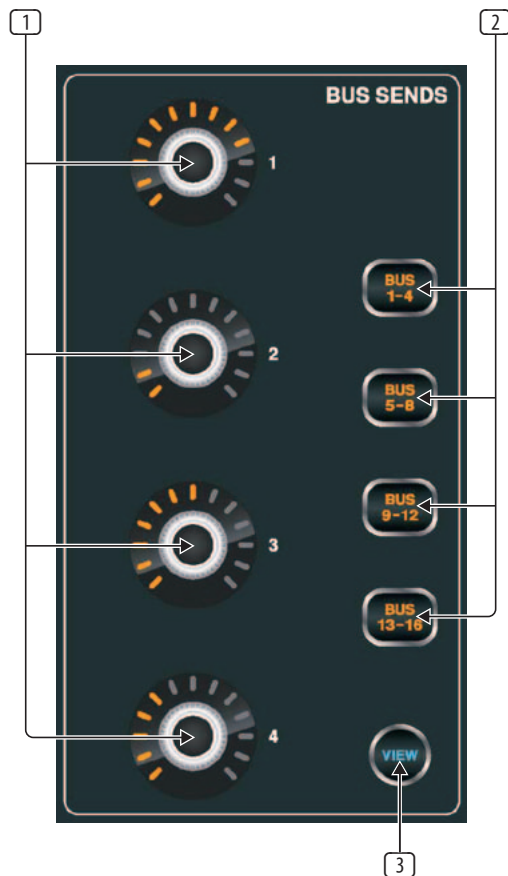
**1.7 Bus Sends****1 Rotary Controls 1-4**

Bus Sends are selected in banks of four with the Select Buttons (see below). The rotary controls adjust each of the four buses currently selected.

**2 Select Buttons 1-4, 5-8, 9-12 & 13-16**

Select one of the banks of Bus Sends with either of the Select buttons on the right of the panel. The bank that is currently selected will be highlighted on the Main Display.

**3 VIEW**

Press the **VIEW** button to access more detailed parameters on the Main Display. See the section **Main Display - sends** for more details.

## 1.8 Main Bus

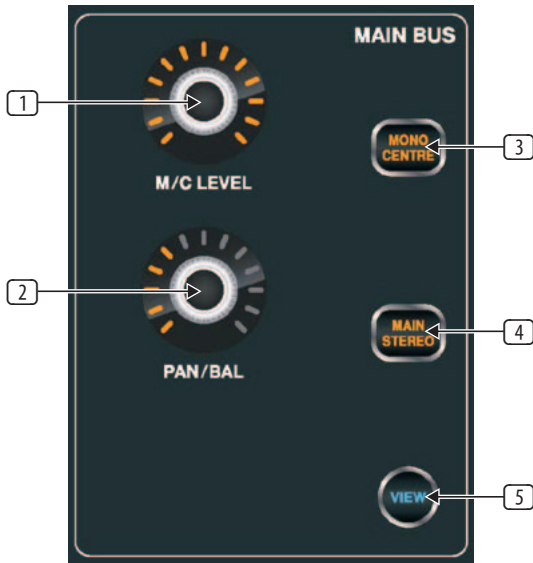

### 1 LEVEL Rotary

Adjust the overall send level to the Mono Bus with the **LEVEL** rotary control.

### 2 PAN/BAL Rotary

When the selected channel is assigned to the Stereo Bus, the **PAN/BAL** rotary control adjusts the left to right positioning of the audio signal.

### 3 MONO

Press the **MONO** button to assign the selected channel to the Main Mono/Centre Bus.

### 4 ST

Press the **ST** select button to assign the selected channel to the Main Stereo Bus.

### 5 VIEW

Press the **VIEW** button to access more detailed parameters on the Main Display. See the section **Main Display - main** for more details.

## 1.9 RECORDER

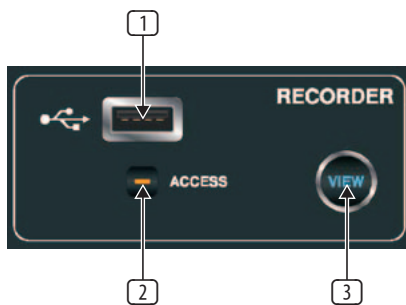

### 1 USB Port

Connect a USB stick to install firmware updates and to record performances.

### 2 ACCESS

The **ACCESS** LED illuminates to indicate that a USB stick is in place and is being written to or read from.

### 3 VIEW

Press the **VIEW** button to open the USB Recorder pages on the Main Display.

### Operation

The M32 offers functionality for playing back uncompressed stereo WAV files, and for recording any available signal in the console directly onto USB stick or compatible USB hard drive.

To record to a USB stick, perform the following steps:



1. Plug a FAT-formatted (FAT12, FAT16, FAT32) USB stick into the USB port as illustrated above.
2. Press the **VIEW** button in the **RECORDER** panel. This will then display a graphic representation of an analogue tape deck on the Main Display **home** tab.
3. On the **config** tab you can select the source of the recording, the default being the main L & R outputs.
4. Press the fifth push encoder, labelled **Record**.



5. To adjust the volume during playback, press the **AUX IN/USB** button next to the input channel faders, and adjust the volume using AUX faders 7 & 8.

## 1.10 Main Display (Summary)



### 1 DISPLAY SCREEN

The controls in this section are used in conjunction with the colour screen in order to navigate and control the graphical elements it contains.

By including dedicated push encoders that correspond to the adjacent controls on the screen, as well as including cursor buttons, the user can quickly navigate and control all of the colour screen's elements.

The colour screen contains various displays that give visual feedback for the operation of the console, and also allow the user to make various adjustments not provided for by the dedicated hardware controls.

### 2 MAIN/SOLO METERS

This triple 24-segment meter displays the audio signal level output from the main bus, as well as the main centre or solo bus of the console.

### 3 SCREEN SELECTION BUTTONS

These eight illuminated buttons allow the user to immediately navigate to any of the eight master screens that address different sections of the console. The sections that can be navigated are:

#### HOME

The **HOME** screen contains an overview of the selected input or output channel, and offers various adjustments not available through the dedicated top-panel controls.

The **HOME** screen contains the following separate tabs:

**home:** General signal path for the selected input or output channel.

**config:** Allows selection of the signal source/destination for the channel, configuration of insert point, and other settings.

**gate:** Controls and displays the channel gate effect beyond those offered by the dedicated top-panel controls.

**dyn:** Dynamics - controls and displays the channel dynamics effect (compressor) beyond those offered by the dedicated top-panel controls.

**eq:** Controls and displays the channel EQ effect beyond those offered by the dedicated top-panel controls.

**sends:** Controls and displays for channel sends, such as sends metering and send muting.

**main:** Controls and displays for the selected channel's output.

## METERS

The **METERS** screen displays different groups of level meters for various signal paths, and is useful for quickly ascertaining if any channels need level adjustment. Since there are no parameters to adjust for the metering displays, none of the metering screens contain any 'bottom of the screen' controls that would normally be adjusted by the six push encoders.

The **METERS** screen contains the following separate screen tabs, each containing level meters for the relevant signal paths: **channel**, **mix bus**, **aux/fx**, **in/out** and **rta**.

## ROUTING

The **ROUTING** screen is where all signal patching is done, allowing the user to route internal signal paths to and from the physical input/output connectors located on the console's rear panel.

The **ROUTING** screen contains the following separate tabs:

**home:** Allows patching of physical inputs to the 32 input channels and aux inputs of the console.

**out 1-16:** Allows patching of internal signal paths to the console's 16 rear panel XLR outputs.

**aux out:** Allows patching of internal signal paths to the console's six rear panel 1/4" / RCA auxiliary outputs.

**p16 out:** Allows patching of internal signal paths to the 16 outputs of the console's 16-channel P16 Ultratnet output.

**card out:** Allows patching of internal signal paths to the 32 outputs of the expansion card.

**aes50-a:** Allows patching of internal signal paths to the 48 outputs of the rear panel AES50-A output.

**aes50-b:** Allows patching of internal signal paths to the 48 outputs of the rear panel AES50-B output.

**xlr out:** Allows the user to configure the XLR outs on the rear of the console in blocks of four, from either local inputs, the AES streams, or expansion card.

## SETUP

The **SETUP** screen offers controls for global, high-level functions of the console, such as display adjustments, sample rates & synchronisation, user settings, and network configuration.

The **SETUP** screen contains the following separate tabs:

**global:** This screen offers adjustments for various global preferences of how the console operates.

**config:** This screen offers adjustments for sample rates and synchronisation, as well as configuring high-level settings for signal path buses.

**remote:** This screen offers different controls for setting up the console as a control surface for various DAW recording software on a connected computer. It also configures the MIDI Rx/Tx preferences.

**network:** This screen offers different controls for attaching the console to a standard Ethernet network. (IP address, Subnet Mask, Gateway.)

**scribble strip:** This screen offers controls for various customisation of the console's LCD scribble strips.

**preamps:** Shows the analogue gain for local mic inputs (XLR at the rear) and phantom power, including setup from remote stage boxes (e.g. DL16) connected via AES50.

**card:** This screen selects the input/output configuration of the installed interface card.

## LIBRARY

The **LIBRARY** screen allows loading and saving of commonly-used setups for the channel inputs, effects processors, and routing scenarios.

The **LIBRARY** screen contains the following tabs:

**channel:** This tab allows the user to load and save commonly used combinations of the channel processing, including dynamics and EQ.

**effects:** This tab allows the user to load and save commonly used effects processor presets.

**routing:** This tab allows the user to load and save commonly used signal routings.

## EFFECTS

The **EFFECTS** screen controls various aspects of the eight effects processors. On this screen the user can select specific types of effects for the eight internal effects processors, configure their input and output paths, monitor their levels, and adjust the various effects parameters.

The **EFFECTS** screen contains the following separate tabs:

**home:** The home screen provides a general overview of the virtual effects rack, displaying what effect has been inserted in each of the eight slots, as well as displaying input/output paths for each slot and the I/O signal levels.

**fx1-8:** These eight duplicate screens display all of the relevant data for the eight separate effects processors, allowing the user to adjust all parameters for the selected effect.

## MUTE GRP

The **MUTE GRP** screen allows for quick assignment and control of the console's six mute groups, and offers two separate functions:

Mutes the active screen during the process of assigning channels to mute groups. This ensures that no channels are accidentally muted during the assignment process during a live performance.

It offers an additional interface for muting/unmuting the groups in addition to the dedicated mute group buttons at the bottom of the console.

## UTILITY

The **UTILITY** screen is a supplemental screen designed to work in conjunction with the other screens that may be in view at any particular moment. The **UTILITY** screen is never seen by itself, it always exists in the context of another screen, and typically brings up copy, paste and library or customisation functions. For example:

- When you are adjusting the EQ of a channel, pressing the **UTILITY** button will offer copying, pasting or loading functionality, or saving of EQ settings
- Pressing the **UTILITY** button while editing a channel's **CONFIG/PREAMP** screen will offer copying, saving or loading preamp configurations

**NOTE:** Pressing the **UTILITY** button while holding the channel Select button is a shortcut to editing the channel's scribble strip display icon, naming or colour.

- On the **ROUTING** screen, pressing **UTILITY** will offer the ability to load or save different presets of routing scenarios
- On the **CUES**, **SCENES**, **SNIPPETS**, **PARAM SAFE** and **CHAN SAFE** pages, pressing **UTILITY** also offers different levels of import/export functions:
- **Cues:** Utility allows importing or exporting complete Show data, including all Cues, Scenes, Snippets and Safes to attached USB media.
- **Scenes:** Utility offers selecting a number of scenes for exporting or importing on attached USB media.
- **Snippets:** Utility offers selecting a number of snippets for exporting or importing on attached USB media.
- **Param Safes/Chan Safes:** Utility allows setting/resetting the Safe flags for a complete column of entries at once.

## 4 PUSH ENCODERS

These six push encoders are used to adjust the various elements located directly above them. Each of the six encoders can be pushed inward to activate a button-press function. This function is useful when controlling elements that have a dual on/off status that is best controlled by a button, as opposed to a variable state that is best adjusted by a rotary control.

## 5 UP/DOWN/LEFT/RIGHT NAVIGATION CONTROLS

The **LEFT** and **RIGHT** controls allow for left-right navigation among the different pages contained within a screen set. A graphical tab display shows which page you are currently on. On some screens there are more parameters present than can be adjusted by the six push encoders underneath. In these cases, use the **UP** and **DOWN** buttons to navigate through any additional layers contained on the screen page. The **LEFT** and **RIGHT** buttons are sometimes used to confirm or cancel confirmation pop-ups.

Please refer to the **MAIN DISPLAY** chapter for more information on these topics.

## 1.11 Monitor

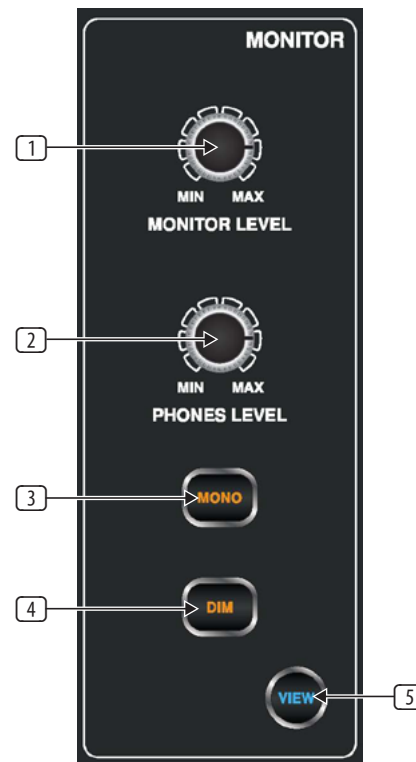

### 1 MONITOR LEVEL Rotary Control

Adjust the level of the monitor outputs with the **MONITOR LEVEL** rotary control. This will be the output device connected to the sockets in the **MONITOR / CONTROL ROOM OUT** section on the rear panel.

### 2 PHONES LEVEL Rotary Control

Adjust the level of the signal through the headphones or other output devices connected via the headphone jack sockets located under the front of the console.

### 3 MONO

Press the **MONO** button to monitor the audio signal in mono.

### 4 DIM

Press the **DIM** button to reduce the monitor volume by a predefined amount. The amount of attenuation can be defined via the Main Display when the **VIEW** button is pressed.

## 5 VIEW

Press the **VIEW** button to access more detailed parameters on the Main Display.

**Operation**

The **MONITOR** section shares a Main Display screen with the **TALKBACK** section. On this screen, only the **monitor** tab contains functionality which relates to the **MONITOR** section. This tab controls various console options relating to the solo bus, as well as the console's control room outputs. These options include various solo settings, speaker dimming, speaker delay, and a selection of sources for the control room output.

To adjust the settings on the **monitor** tab, perform the following steps:

- Adjust the first push encoder to change the gain of the monitor signal. This digital stage occurs as a first preliminary level control, before the top panel's analogue-based monitor level control. A display above the push encoder shows the currently set gain value in dB.
  - A multi-segment level meter is displayed on the Main Display to allow for proper gain staging of the monitor signal.
- Adjust the second push encoder to scroll through the various solo methods available to the console when audio is routed to the solo bus. Available options include:
  - Exclusive (last):** In this mode, pressing another **SOLO** button disengages the previous solo
  - Solo Follows Select:** When this method is selected, the audio of the currently selected channel will automatically be sent to the solo bus. Since a user will often select a channel to adjust its dedicated DSP controls, this method is useful because the audio of the channel will now already be feeding the solo bus where it can be monitored with headphones in a live sound environment



- Select Follows Solo:** When this method is selected, any channel that is soloed will automatically become the currently selected channel
- Ch Solo AFL:** The channel and select button do not have any correlation to each other. When a channel's **SOLO** button is pressed, its audio is sent to the solo bus in 'after-fader-listen' mode, reflecting the current level of the channel fader and any channel DSP that has been applied. The default setting for input channels is off for 'pre-fader-listen'.
- MixBus Solo AFL:** Selecting this method will set the mix bus solo to post-fader
- DCA Solo AFL:** Selecting this method will set the DCA solo to post-fader
- Use DIM for PFL:** Selecting this option will apply **DIM** to all PFL signals
- Use Master Fader:** This allows the main fader/**MUTE** button to control the solo/mon output.

- Tap the second encoder to select and assign the currently chosen solo option.
- Turn the third encoder to adjust the amount of digital delay that is applied to the control room signal path. The display on the screen will show the current amount of delay in feet, metres and milliseconds.
- Tap the third encoder to toggle the delay function on or off.
 

**TIP:** The delay function is useful for aligning the sound of audio monitored through headphones, or speakers used at front-of-house position with audio that is coming from the stage location.

By delaying the control room audio, it can be brought into alignment with the slightly-delayed audio that has to travel from the stage to the front-of-house position.
- Adjust the fourth encoder to set the amount of volume reduction that occurs when the control room bus has its **DIM** function enabled. The amount of volume reduction ranges from -40 dB to 0 dB (no change).
- Tap the fourth encoder to toggle the **DIM** function on or off.
- Turn the fifth encoder to adjust the volume trim for the source currently feeding the control room bus, allowing it to be level matched with the SOLO bus. The amount of trim can be adjusted from -20 dB to +20 dB.
- Tap the fifth encoder to toggle the control room between mono and stereo operation. This is very useful in a studio context for checking how a mix sounds when played back on a mono speaker such as a cock radio.
- Adjust the sixth encoder to select what specific signal source to monitor in the control room. Choices include:
  - Off (no source) in the control room, when no SOLO is active
  - LR Bus
  - LR + C/M
  - LR PFL (Pre-Fade Listen)
  - LR AFL (After-Fade Listen)
  - Auxiliary returns 5/6
  - Auxiliary returns 7/8 (USB Recorder).
- Tap the sixth encoder to activate the signal source that has been chosen.

## 1.12 Talkback



### 1 EXT MIC Port

Connect a microphone to the console via a standard XLR cable. The output carries 48 V phantom power, allowing the use of condenser or dynamic microphones.

### 2 TALK LEVEL Rotary Control

Adjust the level of the Talkback volume with the **TALK LEVEL** rotary control.

### 3/4 TALK A / B

Select the destination of the Talkback mic signal with either the **TALK A** or **TALK B** buttons. Press the **VIEW** button to edit the Talkback routing for A and B.

### 5 VIEW

Press the **VIEW** button to access more detailed parameters on the Main Display.

### Operation

#### talkback Tab

The **TALKBACK** screen offers various adjustments for the talkback paths of the console, such as destination of the talkback signal and more.

To adjust the various settings on the **talkback** tab, perform the following steps:



1. The screen displays a multi-segment level meter showing the strength of the talkback signal as it has currently been set. It also displays a multi-segment gain reduction meter, showing the user how much compression has been automatically applied to the talkback signal.
2. Tap the first push encoder to enable the talkback circuit. The internal/external talkback microphone will now transmit audio to the **talkback** path's assigned destination.
3. Adjust the third encoder to set the gain of the **talkback** signal. This is an additional gain stage that follows the initial gain stage set by the top panel **TALK LEVEL** control.
4. Tap the third encoder to toggle on/off the talkback circuits 'auto-dim' function. This function is useful in a studio setting, and will automatically dim the control room outputs when the talkback circuit is active. This prevents the talkback microphone from picking up too much sound from the nearby studio monitors.
5. Adjust the fourth encoder to scroll through the various talkback destinations, which include:
  - Mix Bus 1-16
  - LR Bus
  - Centre/Mono Bus.
6. Tap the fourth encoder to activate any talkback destination when it is currently selected. Multiple talkback destinations can be selected, allowing the talkback signal to reach many destinations at the same time.
7. Tap the fifth encoder to toggle the dedicated top-panel talkback buttons between latching and non-latching operation.
8. Turn the sixth encoder to adjust the brightness of the lamp that is connected to the console's rear panel lamp connector.
9. Tap the sixth encoder to toggle the attached lamp on or off.

#### oscillator Tab

The **oscillator** tab offers controls for the console's onboard oscillator, a very handy tool that can be used for setting up PA systems and testing various signal flow paths without the need for a live source feeding a microphone. Settings include oscillator type, frequency, volume and routing destinations.

To adjust the various settings on the oscillator tab, perform the following steps:



1. Adjust the first push encoder to set the level of the onboard oscillator.
2. Tap the first encoder to toggle the oscillator on or off.
  - The Main Display shows a multi-segment level meter that shows the current level of the oscillator.
3. Adjust the second encoder to set the frequency of the primary onboard oscillator.
4. Adjust the third encoder to set the frequency of the alternate onboard oscillator.
5. Tap the third encoder to alternate between Sine F1 and Sine F2.

6. Adjust the fourth encoder to select the type of oscillator to be used. Choices include:
  - Sine Wave
  - Pink Noise
  - White Noise.
7. Tap the fourth encoder to engage the selected oscillator type.
8. Adjust the sixth encoder to select a destination for the onboard oscillator. Choices include:
  - Mix Bus 1-16
  - Main L Bus
  - Main R Bus
  - Main L+R Bus
  - Main Centre / Mono
  - Matrix Outputs 1-6.
9. Tap the sixth encoder to assign the selected oscillator destination.

### 1.13 Show Control

The **SHOW CONTROL** section on the control surface can be used to select, activate and navigate saved Cues, Scenes or Snippets, depending on the selected preference on SETUP/global.

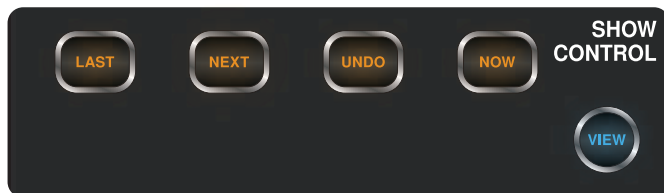

**LAST** - navigates to the previous scene.

**NEXT** - navigates to the next scene.

**UNDO** - undoes the previous action.

**NOW** - navigates to the current scene.

**VIEW** - This give you access to more detailed parameters of the **SCENES** function via the Main Display.

The **SCENES** screen on the Main Display allows setup for saving and recalling different memory scenes of the M32. The comprehensive recallability of the console (including gain settings for the digitally-controlled mic preamps) is one of the most powerful aspects of the console.

The **SCENES** screen contains the following separate tabs:

**home:** This screen contains a general overview of the scenes contained in the console, along with their custom names and what parameters are included in each scene.

**scenes:** This screen allows the user to configure, edit and rename the individual scenes.

**snippets:** This screen allows for the editing of the new 'Snippets' functionality.

**param safe:** This screen configures which console parameters are and are not saved or switched with the console scenes.

**chan safe:** This screen configures which console channels are and are not changed when a console scene change occurs.

**MIDI:** This screen allows the console to associate different scenes with incoming and outgoing MIDI messages, allowing the console's scene changes to control or be controlled by external MIDI equipment.

### HOME

The **SHOW CONTROL** screen's **home** tab shows a general overview of the Cues that have been configured in the console, along with their custom names and what parameters are included in each Cue.

A Cue is simply a single event (such as a Scene, Snippet or MIDI command) or a collection of events. These can be grouped together and stored for future recall. Up to 500 Cue entries can be stored in the M32 at any time.

For a setting where these events are used heavily and are critical (such as a theatre performance), this would be a good screen to leave on at all times so that the console operator can be completely sure what Cue the console currently resides on, and what Cue will come up next when the **GO** button is pressed.

To adjust the various Cue settings on the **home** tab, perform the following steps:



1. Rotate the first push encoder to scroll among the available Cues in the list, which is displayed on the left side of the Main Display.
2. Tap the first push encoder to go to the currently selected Cue in the list, switching the console to the state it was in when that Cue was stored.
3. Turn the second push encoder to select a Cue in the list to be skipped when cycling through Cues using the **LAST** and **NEXT** buttons.
4. Tap the second push encoder to complete the skip command on the currently selected Cue. That Cue will now be skipped when scrolling through the list.
5. Turn the third push encoder to scroll back through recent changes.
6. Tap the third push encoder to undo the recent change.
7. Turn the fourth encoder to select a slot to save a new Cue.
8. Tap the fourth push encoder to complete the save operation. The console's current state will be overwritten on the Cue number that was selected with the push encoder.
9. Turn the sixth rotary to select which aspects of the console's routing are excluded from a Cue change, and will be unaffected by any Cue changes that occur. Routing choices that can be made safe include:
  - Routing
  - Output Patch
  - Mic Preamp Gain (HA, short for Head-Amplifier)
  - Configuration
  - Channel Processing
  - Mix Buses
  - Effects
  - Talkback.
10. Tap the sixth push encoder to select any of the above choices as the encoder rotation is used to select them. Multiple categories can be selected at the same time.



## Utility

Pressing the **UTILITY** button to the right of the Main Display changes the bottom of the **home** tab to the following configuration:



Each of the functions on this layer can be controlled with the adjacent push encoder as follows:

**Copy** - Allows the user to make a copy of the currently-selected Cue.

**Edit Cue** - Allows the user to edit the currently-selected Cue.

**Add Cue** - Adds a new Cue into the current Showfile.

**Delete** - Deletes the currently-selected Cue.

**Import Show** - Imports a Showfile from a connected USB drive.

**PLEASE NOTE** that this will replace the existing Showfile, so this should be saved beforehand.

**Export Show** - Exports the current Showfile to a connected USB drive.

## SCENES

Use the **Load**, **Save** and **Edit** functions by pressing the adjacent push encoder to load, save and edit the scenes. The **Scenes Safe** function works in a similar way to the **PARAMETER SAFE** function, though only applies to specific scenes.

## Utility

Pressing the **UTILITY** button to the right of the Main Display changes the bottom of the **scenes** tab to the following configuration:



Each of the functions on this layer can be controlled with the adjacent push encoder as follows:

**Copy** - Allows the user to make a copy of the currently-selected Scene.

**Paste** - Pastes a Scene from the virtual clipboard.

**Edit** - Allows the user to edit the currently-selected Scene.

**Delete** - Deletes the currently-selected Scene.

**Import Scenes** - Imports a Scene from a connected USB drive.

**Export Scenes** - Exports a Scene to a connected USB drive.

## SNIPPETS

The M32 has a new flexible structure called 'Snippets', which allows for setting selective parameters and channel filters for storage. Recalling a Snippet will exclusively affect the stored bits of information, leaving the remaining console status untouched. This allows to surgically introduce specific bits of automation into the current mix status. Up to 100 Snippets can be stored at any time. Use the **Load**, **Save** and **Edit** functions by pressing the adjacent push encoder to load, save and edit the Snippet.

A Snippet can be focused on any specific selection of parameters a user may find suitable, such as EQ, Insert, Fader, Mute, Send levels, etc. A Snippet will also be focused on a random selection of channels (inputs, returns or any mixes). When loading this Snippet only the previously stored information will replace the respective console parameters, while the rest remains as is.

## Utility

Pressing the **UTILITY** button to the right of the Main Display changes the bottom of the **snippets** tab to the following configuration:



Each of the functions on this layer can be controlled with the adjacent push encoder as follows:

**Copy** - Allows the user to make a copy of the currently-selected Snippet.

**Paste** - Pastes a Snippet from the virtual clipboard.

**Edit** - Allows the user to edit the currently-selected Snippet.

**Delete** - Deletes the currently-selected Snippet.

**Import Snippets** - Imports the selected Snippet(s) from a connected USB drive.

**Export Snippets** - Exports the selected Snippet(s) to a connected USB drive.

## PARAMETER SAFE

The **SHOW CONTROL** screen's **param safe** tab configures which of the M32's parameters are or are not saved or switched with the console scenes. This is very useful when the operator has certain parameters of which they wish to remain in control, and would never want to have altered during a scene change, for example the mic pre gains on the input channels.

To adjust the various settings on the **param safe** tab, perform the following steps:

1. Turn any of the first four push encoders to navigate among the checkboxes on the Main Display, which represent various console areas that can be isolated from scene changes.
2. Tap any of the first four push encoders to select the console areas that have been selected with the push encoders. In each of the four columns, multiple console areas can be selected an isolated from scene changes.

The following areas of the M32 can be isolated from scene changes, and are divided up into four columns on the Main Display:

### Column 1: Input Channels

- HA (Head Amp / Microphone Preamp)
- Configuration
- Channel EQ
- Channel Gate / Compressor
- Channel Insert
- Channel Groups
- Fader, Pan, Mute, Mix Ons.

### Column 2: Input Channels

- Mix Sends 1-16.

### Column 3: Mix Buses

- Mix Sends 1-16
- Configuration
- EQ
- Compressor
- Insert
- Groups
- Fader, Pan, Mute, Matrix Ons.

**Column 4: Console**

- Configuration
- Solo
- Routing
- Output Patch.

**CHANNEL SAFE**

The **SHOW CONTROL** screen's *chan safe* tab configures which console channels are and are not changed when a scene change occurs. This allows the user to protect certain channels from ever changing during a scene change, giving them as much control as possible for key audio sources.

For example, in a theatre context, the console operator may have dialled in just the right EQ and compressor settings, and channel volume for the voice of the lead actor, and does not want to have them altered when the console changes scenes and alters various other parameters.

To adjust the various settings on the *chan safe* tab, perform the following steps:

1. Turn any of the six push encoders to navigate among the checkboxes on the Main Display, which represent various groups of channels that can be isolated from scene changes.
2. Tap any of the six encoders to select the console areas that have been highlighted with the push encoders. In each of the six columns, multiple console areas can be selected and isolated from scene changes.

The following areas of the M32 can be isolated from scene changes, and are divided up into six columns on the Main Display:

**Column 1: Channels**

- Input Channels 1-16

**Column 2: Channels**

- Input Channels 17-21.

**Column 3: Buses**

- Aux 1-8
- FX 1L through 4R.

**Column 4: Returns**

- Mix 1-6.

**Column 5: Main / Matrix / Groups**

- Matrix 1-6
- LR Bus
- Centre / Mono Bus
- DCA Groups 1-8.

**Column 6: Effects Slots**

- FX 1-8.

**MIDI**

The **MIDI** tab on the **SHOW CONTROL** screen allows the console to associate different Cues with incoming and outgoing MIDI messages, allowing the console's scene changes to control or be controlled by external MIDI equipment.

For instance, the user could configure the console to issue a MIDI Program Change message as each new Cue is recalled, with the outgoing MIDI message triggering a MIDI-equipped lighting controller.

Conversely, the user could configure the console to change Cues in response to an incoming MIDI Program Change message, allowing the console to switch to a new audio scene when a new scene is recalled on a MIDI-equipped lighting controller.

To adjust the various settings on the **MIDI** tab, perform the following steps:

1. Turn the first push encoder to select a Cue to edit.
2. Turn the third push encoder to select what type of MIDI event is transmitted by the console when a scene change is issued. The choices include:
  - Off (no MIDI event)
  - MIDI Program Change
  - MIDI Control Change
  - Note.
3. Push encoders 4, 5 and 6 adjust the channel, number and value or velocity, where applicable.

The Main Display shows the MIDI data associated with the currently selected screen.

**1.14 Assign****Rotary Controls 1-4**

Assign the four rotary controls to various parameters for instant access to commonly used functions. Details can be found on the Main Display by pressing the **VIEW** button (see below).

**LCD Displays**

These displays provide quick reference to the assignments of the active layer of custom controls.

**Buttons 5-12**

Assign the eight buttons to various parameters for instant access to commonly used functions. Details can be found on the Main Display by pressing the **VIEW** button (see below).

**SET Buttons A, B, C**

The currently active set, A, B or C, is indicated by a radio button and an amber outline on the main display.

Press the left (1st) push-encoder to toggle through the sets, and press the right (6th) push-encoder for opening the corresponding edit page.

Alternatively, you may use the page left and right buttons below the main display, for navigating between the tabs.

**VIEW**

This gives you more detailed access to the **ASSIGN** functions via the Main Display.

The **ASSIGN** screen allows setup for the four user-assignable rotary controls and the eight user-assignable buttons. Using this screen the console operator can assign three sets of 12 custom controls to be available for adjustment at all times.

The **ASSIGN** screen contains the following separate tabs:

**home:** This screen provides a general overview of the 12 assigned controls for all three control sets at the same time.

**set A:** This screen allows assignment of different console parameters to the 12 custom controls for Set A.

**set B:** Works as described above, but for custom controls Set B

**set C:** Works as described above, but for custom controls Set C

## HOME



The **ASSIGN** screen's **home** tab provides a visual overview of the 12 assigned controls for all three sets at the same time.

The **home** tab offers visual feedback of the controls that have been assigned to all three sets of custom controls, without having to bank between the three sets one-by-one, or relying on abbreviated syntax shown in the custom control's dedicated LCD displays.

To adjust the various settings on the **home** tab, perform the following steps:

1. Turn any of the push encoders 1-5 to move screen focus to different custom-assignable rotary controls and buttons in the A, B and C sets. The controls currently selected with each of the four rotary controls are highlighted with an orange outline.
2. Tap any of the push encoders 1-5 to switch to the edit screen for the specific custom control that was highlighted on the **home** tab screen.

## SET A, B & C

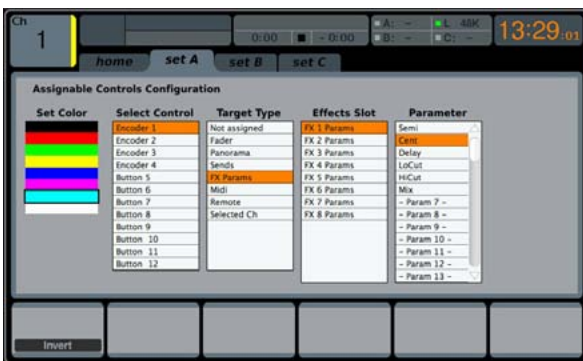

The **set A, B & C** tabs allow mapping of specific console parameters to the eight assignable buttons and four assignable rotary controls. Using these screens the user can map the exact parameters that are most useful to them to the desired controls, in the desired order.

To adjust the various settings on the **set A, B & C** tabs, perform the following steps:

1. Adjust the first push encoder to select the colour used for the LCD screens within that set.
2. Adjust the second push encoder to select to which of the 12 assignable controls in the appropriate set you wish to map a parameter.

3. Adjust the third push encoder to scroll through a list of parameter categories to which the selected assignable control can be mapped. Choices for the buttons include:

- Not Assigned
- Jump to Page
- Mute Channel
- Inserts
- Effect Button
- MIDI
- Remote.

Choices for the rotary controls include:

- Not Assigned
- Panorama
- Sends
- Dynamics
- FX Parameters
- MIDI
- Remote.

4. Tap the third push encoder to select the desired type of parameter.
5. Where applicable, tap/select the fourth, fifth and sixth push encoders to assign the specific parameter.

## 1.15 Mute Groups



Use these buttons to select and activate or deactivate one of the user-defined Mute Groups.

The **MUTE GRP** screen allows for quick assignment and control of the console's six mute groups, and offers two separate functions:

1. It disables the buttons in the MUTE GROUPS section during the process of assigning channels to mute groups. This ensures that no channels are accidentally muted during the assignment process in a live performance.
2. It offers an alternative interface for muting or unmuting the mute groups while the dedicated mute group buttons on the console's control surface are blocked.

When activated, the **MUTE GRP** screen only covers the bottom portion of the Main Display, allowing the middle portion to continue displaying the usual screen content.

To assign channels to one of the six mute groups, perform the following steps:

1. Press the **MUTE GRP** screen selection button to switch the main display to the Mute Groups view.
2. Press and hold the desired mute group button on the lower right-hand side of the console's control surface.
3. While holding the mute group button, press the **SEL** button of any input or output channel, on any layer, that you wish to assign to that mute group.

- When you have assigned all of the desired channels to the mute group, release the dedicated Mute Group button.

**NOTE:** The individual channel MUTE buttons will remain fully functional during the assignment process, only the mute group buttons are blocked.

To use the **MUTE GRP** screen to mute or unmute the groups, perform the following steps:

- Tap any of the six push encoders to mute the corresponding group, and thus mute all channels that are assigned to that mute group.
- Tap the push encoder of a currently-muted group to unmute the mute group.
- When finished working with mute groups, tap the **MUTE GRP** screen selection button to exit the **MUTE GRP** screen. The entire screen will again display its full set of controls for the current page.

## 2. Main Display

### 2.1 Main Display - Top Section

The top section of the **Main Display** permanently covers useful status information. The top left corner shows the selected channel number, its user-assigned name and the selected icon. The next block shows the current scene number and name in amber, as well as the next upcoming scene. The centre section displays the playback file name along with elapsed and remaining time, and a recorder status icon. The next block to the right has four segments to show the status of the AES50 ports A and B, the Card slot, and the audio clock synchronisation source and sample rate. Small green square indicators show proper connectivity. The rightmost block shows the console time, which can be set under **Setup - Config**.

#### 2.1.1 Home

The **HOME** screen contains a high-level overview of the selected input or output channel, and offers various adjustments not available through the dedicated top-panel encoders.

The **HOME** screen is divided into the following tabs:

**home:** General signal path for the selected input or output channel.

**config:** Allows selection of signal source/destination for the channel, configuration of insert point, and other settings.

**gate:** Controls and displays the channel gate effect beyond those offered by the dedicated top-panel encoders.

**dyn:** Controls and displays the channel dynamics effect (compressor) beyond those offered by the dedicated top-panel encoders.

**eq:** Controls and displays the channel EQ effect beyond those offered by the dedicated top-panel encoders.

**sends:** Controls and displays the channels sends, such as sends metering and sends muting.

**main:** Controls and displays the selected channel's output.

### home

The **home** tab of the **HOME** screen displays a general signal path for the currently selected input or output channel. It visually displays various parameters of the input, gate, insert point, EQ, dynamics, output path and buses.



The **home** tab contains the following parameters (divided into two pages) that can be adjusted using the six push encoders.

#### Page 1

- Turn the first push encoder to adjust the input gain (trim) of the channel.
- Tap the first encoder to link the channel with its adjacent channel.
- Adjust the second encoder to set the threshold of the channel noise gate.
- Tap the second encoder to toggle the channel noise gate in/out of the signal path.
- Adjust the third encoder to toggle the channel's insert point between pre-fader and post-fader status.
- Tap the third encoder to toggle the channel insert in/out of the signal path.
- Adjust the fourth encoder to toggle the channel dynamics between pre-EQ and post-EQ status.
- Tap the fourth encoder to toggle the channel EQ in/out of the signal path.
- Adjust the fifth encoder to set the threshold of the channel compressor.
- Tap the fifth encoder to toggle the channel compressor in/out of the signal path.
- Adjust the sixth encoder to pan the selected channel within the main stereo output.
- Tap the sixth encoder to assign the selected channel to the main stereo output.

#### Page 2

- Adjust the first push encoder to select the console channel currently controlled by the HOME screen.
- Tap the first encoder to toggle +48V phantom power on/off for the currently selected input.
- Tap the second encoder to toggle the phase flip on/off for the currently selected channel.
- Adjust the third encoder to select to which of the eight DCA groups the currently selected channel will be assigned.
- Tap the third encoder to assign the currently selected channel to the selected DCA group.

6. Adjust the fourth encoder to select to which of the six mute groups the currently selected channel will be assigned.
7. Tap the fourth encoder to assign the currently selected channel to the selected mute group.
8. Tap the fifth encoder to toggle solo on/off for the currently selected channel.
9. Turn the sixth encoder to adjust the fader level for the currently selected channel.
10. Tap the sixth encoder to toggle mute on/off for the currently selected channel.

## config

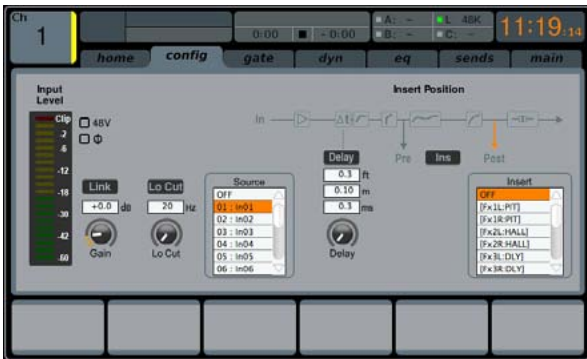

The **configuration** tab allows selection of signal source/destination for the channel, configuration of insert point, and other settings, as well as configuration of the channel delay.

The **config** tab of input channels 1-32 contains the following parameters that can be adjusted using the six push encoders:

1. Turn the first push encoder to adjust the input gain (trim) of the channel.
2. Tap the first encoder to allow linking of the channel to the adjacent channel.
3. Adjust the second encoder to set the low-cut frequency of the channel.
4. Tap the second encoder to toggle the low-cut filter in/out of the signal path.
5. Adjust the third encoder to scroll among all of the possible sources for the channel.
6. Tap the third encoder to select the currently highlighted source and assign it to the channel.
7. Adjust the fourth encoder to set the amount of digital line delay applied to the channel.
8. Tap the fourth encoder to toggle the delay in/out of the signal path.
9. Adjust the fifth encoder to toggle the channel insert between pre- and post-EQ/compressor.
10. Tap the fifth encoder to toggle the channel insert in/out of the signal path.
11. Adjust the sixth encoder to scroll among the signal path choices for the insert point.
12. Tap the sixth encoder to assign the selected signal path to the insert point.

**NOTE:** Mix Bus channels do not have Gain, Low Cut, Phantom, Phase, Source and Delay. But they do have a macro feature for setting all channel send taps to the selected bus at once. As an example, this can be used for switching all sends from Pre Fader to Post Fader or for ensuring that all channel taps are consistent.

## gate



The **gate** tab displays all aspects of the channel noise gate, and allows for very deep control of the gate effect. Whereas the top panel's dedicated **GATE** section allows control of the gate's threshold and in/out status, the gate tab offers many more controls. This tab can be accessed directly by pressing the **VIEW** button in the top panel **GATE** section.

The **gate** tab contains the following parameters, divided among two pages, that can be adjusted using the six push encoders:

### Page 1

1. Adjust the first push encoder to set the input threshold of the gate.
2. Tap the first encoder to toggle the noise gate in/out of the signal path.
3. Adjust the second encoder to set the range of a 'ducking effect' applied to the channel.
4. Tap the second encoder to toggle the ducker effect in/out of the signal path.
5. Adjust the third encoder to set the attack time of the onset of the noise gate effect.
6. Adjust the fourth encoder to set the hold time of the noise gate effect.
7. Adjust the fifth encoder to set the release time of the noise gate, controlling how quickly the gate opens up and lets the signal through.

### Page 2

1. Push encoders 1 & 2 function the same on pages 1 & 2.
2. Adjust the fourth encoder to set the frequency of the key filter that can be used to trigger the noise gate.
3. Tap the fourth encoder to toggle the key filter on/off, allowing a specific frequency to control the gate.
4. Adjust the fifth encoder to set the steepness of the EQ slope used in the key filter.
5. Tap the fifth encoder to send the key source to the solo bus, allowing the key source to be monitored and evaluated.
6. Adjust the sixth encoder to select the specific key source to be used. Choices include 'Self' (the channel's own signal), as well as any other input/output of the console.
7. Tap the sixth encoder to assign the selected key source to the gate.

## dyn



The **dynamics** tab displays all aspects of the channel compressor, and allows for very deep control of the effect. Whereas the top panel's dedicated compressor section allows control of the threshold and in/out status, the **dyn** tab offers many more controls. This tab can be accessed directly by pressing the **VIEW** button in the top panel **DYNAMICS** section.

The **dyn** tab contains the following parameters that can be adjusted using the six push encoders:

**Page 1**

1. Adjust the first push encoder to set the input threshold of the compressor.
2. Tap the first encoder to toggle the compressor in/out of the signal path.
3. Adjust the second encoder to set the ratio of the compressor.
4. Tap the second control to switch the channel dynamics effect between compression and expansion.
5. Adjust the third encoder to set the attack time of the compressor effect.
6. Tap the third encoder to switch the compressor between Peak and RMS (root mean squared) mode, where the average level of the signal is evaluated more than any specific peak of the channel material.
  - **PEAK:** A peak-sensing compressor responds to the instantaneous level of the peak signal. While providing tighter peak control, peak sensing might yield very quick changes in gain reduction, more evident compression, or sometimes even distortion. This mode is suitable for control/limiting of dynamic material.
  - **RMS:** In this mode, the compressor applies an average function on the input signal before its level is compared to the threshold. This allows a more relaxed compression that also more closely relates to our perception of loudness. Sharp dynamic transients will be less affected in this mode. This mode is good for controlling levels in a mix.
7. Turn the fourth encoder to adjust the hold time of the compressor.
  - Hold time is a parameter not often found on commercial units, but is very useful. If a compressor is set to use a very fast attack/release time, audible distortion can occur, because the compressor is trying to work on individual waveform cycles of the signal instead of the sound envelope as a whole. The Hold parameter works around this issue by providing a short delay. This delay prevents the compressor from releasing until a certain period of time has elapsed.

8. Tap the fourth encoder to switch between Linear and Logarithmic modes for the compressor. Following are some brief descriptions of those different modes:

**LOG:** This mode is used in many well-respected compressors and is the natural result of more recent analogue units employing logarithmic side chains and resistor/capacitor time constants. The exponential/dB law has some interesting characteristics. Firstly the time taken to complete a compression event tends to stay the same however large the dynamic signal excursion is. Also, since the peak rate of gain change increases with dynamic excursion, the resulting harmonic content due to compress tends to follow the loudness of the signal in a way that the ear expects. This helps to mask the effect of the compressor and thus provides the most forgiving solution, being tolerant of differing timing settings and signal material. This makes it the best choice for general compression use and overall dynamic control of complex musical signals.

**LINEAR:** In this mode, the rate of gain change is constant (as set by the timing controls). Therefore the greater the signal dynamic excursion, the longer the compressor will take to complete a gain change. Also, since the total time that the compressor spends in attack or decay is proportional to the size of the gain excursion, the harmonic content of the compression artefact will seem to reduce in frequency content, the louder the signal excursion. This type of compressor is useful for generating dynamic sound effects because the sonic character of the compressor is much more affected by time control settings and signal material than the exponential type.

9. Adjust the fifth encoder to set the release time of the compressor.
10. Adjust the sixth encoder to set the makeup gain of the compressor; useful when the compression effect has reduced the overall signal level of the channel too much.

**Page 2**

1. Push encoders 1 & 2 function the same on pages 1 & 2.
2. Adjust the third encoder to set the steepness of the compressor knee angle between five separate settings. Adjust this control to switch between a harder sounding, or more transparent compressor effect.
3. Tap the third encoder to move the compressor effect before or after the EQ in the channel signal path.
4. Adjust the fourth encoder to set the frequency of the key filter that can be used to trigger the compressor.
5. Tap the fourth encoder to toggle the key filter on/off, allowing a specific frequency to control the compressor.
6. Adjust the fifth encoder to set the steepness of the EQ slope used in the compressor.
7. Tap the fifth encoder to send the key source to the solo bus, allowing the key source to be monitored and evaluated.
8. Adjust the sixth encoder to select the specific key source to be used, Choices include 'Self' (the channel's own signal), as well as any other input/output of the console.
9. Tap the sixth encoder to assign the selected key source to the compressor.

## eq

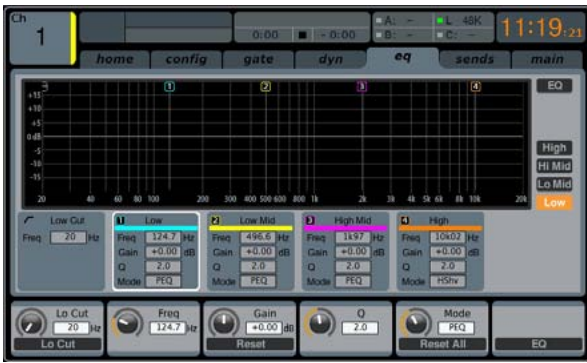

The **eq** tab displays all aspects of the channel EQ, and also displays a detailed visual graphic of the current EQ curve. This tab can also be accessed directly by pressing the **VIEW** button on the top panel **EQUALISER** section.

1. If the currently selected channels is an input, the channel EQ contains four bands, with various aspects of each band adjusted by push encoders 2-5.
2. If the currently selected channel is a bus, the channel EQ contains six bands, with various aspects of each band adjusted by encoders 1-6.
3. On the EQ screen, the various push encoders are always tied to the various EQ bands, and the Up/Down navigation controls are used to toggle whether the four/six push encoders adjust:
  - Gain
  - Frequency
  - Width
  - EQ mode.

**Page 1 (Gain)**

1. Adjust the first push encoder to set the frequency of the channel low-cut filter.
2. Tap the first encoder to toggle the low-cut filter in/out of the signal path.
3. Adjust the second encoder to boost/cut the gain of the low band.
4. Adjust the third encoder to boost/cut the gain of the low-mid band.
5. Adjust the fourth encoder to boost/cut the gain of the high-mid band.
6. Adjust the fifth encoder to boost/cut the gain of the high band.
7. Tap the sixth encoder to toggle the EQ in/out of the signal path.

**Page 2 (Frequency)**

1. Works as above, but the push encoders now adjust the frequency centre points for the different EQ bands.

**Page 3 (Width)**

1. Works as above, but the push encoders now adjust the bandwidth for the different EQ bands. Use a narrow slope for working with a specific frequency, or use a broader slope for general tone-shaping.

**Page 4 (Mode)**

1. Works as above, but the push encoders now adjust the EQ mode for each EQ band. Choices include:
  - Low cut
  - Low shelf
  - Parametric EQ
  - Vintage EQ
  - High shelf
  - High cut.

## sends

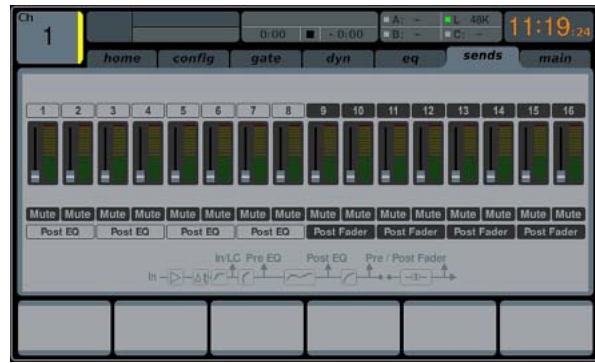

The **sends** tab displays and controls all aspects of the channel sends to the 16 mix buses. Compared to the dedicated top panel send controls, this screen offers additional functions, such as send muting and simultaneous metering of the selected channel's 16 sends. This tab can also be accessed directly by pressing the **VIEW** button in the top panel **SENDS** section.

The **sends** tab contains the following parameters that can be adjusted using the six push encoders:

**Page 1**

1. Adjust the first push encoder to set the level for the first send of the currently selected four-send group.
2. Tap the first encoder to mute the first send of the currently selected four-send group.
3. Repeat the process with the next three encoders for the remaining three sends in the currently selected four-send group.
4. Adjust the sixth encoder to select which four sends to control with the rotary controls, shifting focus two sends at a time.
5. Tap the sixth encoder to select which four sends to control with the rotary controls, shifting focus four at a time.

**Page 2**

1. Adjust the first push encoder to select from where in the signal chain the send is tapped, for the first two sends of the currently focused four sends. Options include:
  - Pre-EQ
  - Post-EQ
  - Pre-fader
  - Post-fader
  - Sub-group.
2. Adjust the third encoder to perform the same operation for the second two sends of the currently focused four sends.
3. Adjust the sixth encoder to select which four sends to control with the rotary controls, shifting focus two sends at a time.
4. Tap the sixth encoder to select which four sends to control with the rotary controls, shifting focus four at a time.

## main



The **main** tab displays and controls all aspects of the main bus assignments.

The **main** tab contains the following parameters that can be adjusted using the six push encoders:

1. Adjust the first push encoder to pan the selected channel within the main stereo output.
2. Tap the first encoder to assign the selected channel to the main stereo output.
3. Turn the second encoder to adjust the level of the currently selected channel within the mono (centre) bus.
4. Tap the second encoder to assign the selected channel to the mono output signal path. Use this function when crafting an LCR mix, as opposed to a mono or stereo mix.
5. Tap the fifth encoder to solo/unsolo the currently selected channel.
6. Adjust the sixth encoder to set the fader level for the currently selected channel.
7. Tap the sixth encoder to mute/unmute the currently selected channel.

## 2.2 Meters

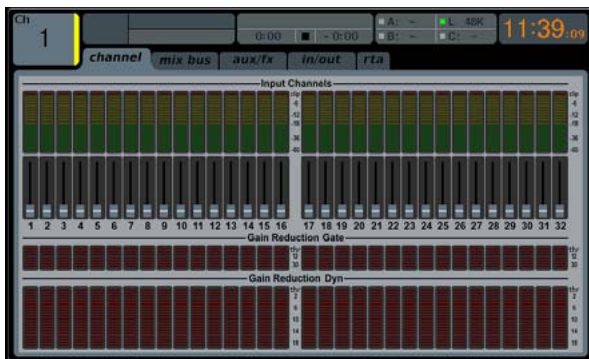

The **METERS** screen displays different groups of level meters for various signal paths on the console, and is useful for quickly ascertaining if any channels need level adjustment. Since there are no parameters to adjust for the metering displays, none of the metering screens (with the exception of the **rta** tab; see below) contain any 'bottom-of-screen' controls that would normally be adjusted by the six push encoders.

The **METERS** screen contains the following separate screen tabs, each containing level meters for the following signal paths:

### channel

- Level meters and fader levels for the 32 input channels.

### mix bus

- Level meters, fader levels and gain reduction meters for the 16 bus masters
- Level meters, fader levels and gain reduction meters for the six matrix outputs

- Level meters, fader levels and gain reduction meters for the stereo main bus and the mono bus.

### aux/fx

- Level meters for the six auxiliary sends
- Level meters and fader levels for the eight auxiliary returns
- Level meters and fader levels for the four stereo effects returns.

### in/out

- The 32 input channels
- The eight auxiliary returns
- The six auxiliary sends
- The two rear panel digital outputs
- Monitor outputs
- The 16 rear panel analogue outputs
- The P16 Ultraset outputs.

### rta

The **rta** tab shows details of the M32's Real Time Analyser - a real-time spectrum analyser that displays details of the audio signal on the selected signal path. The M32 features both bar graph and spectrograph with a 10-second window, that are displayed on the Main Display, and can be used in a variety of applications. The frequency resolution of both analysers is 100 bands, with constant relative bandwidth from 20 Hz to 20 kHz. Hence they are three times more detailed than typical third-of-an-octave RTAs. Both graphs can be visualised in a separate Meter screen, on top of each channel parametric EQ and on the FX rack graphic EQ screens.

### RTA Source



Depending on the application the analyser input signal can be taken from the selected channel itself, any other pre-defined channel or dynamically depending on monitor source signals (i.e. Main/Solo). When EQ-ing a main PA system for example, the Graphic EQ may be inserted in Main LR, while the analyser signal may come from a dedicated measuring mic input channel. Select the source signal using the sixth push encoder.

### Solo Priority

When switched on, the selected RTA source signals will be replaced with the monitor solo bus whenever a channel solo is active.

**TIP:** *This option might be useful, if you wish to analyse a group of channels concurrently, or if you have a fixed signal on the RTA that needs to be replaced only temporarily with some other channel's signal.*

### Pre / Post

The analysers can tap their input signals from pre- or post-EQ, allowing you to see the impact of your EQ in that channel. Tap the fifth push encoder to toggle between the two.



## Gain

When engaged, the Auto Gain function simplifies adjusting the analyser views and ensuring meaningful readings. In most cases it should be switched on. When switched off, the RTA gain can be set manually using the push encoder, which may be necessary for comparing absolute frequency band levels between different channels. Tap the fourth push encoder to engage the Auto Gain function.

## EQ Overlay

When using the analysers on top of the channel EQ plot or over the graphic EQ screens, the meter's opacity can be adjusted to your liking. Something around 50% is typically a good starting point. Turn it down to 0% with the fifth push encoder if you don't need to see the RTA on top of the channel EQ or graphic EQ screens.

## RTA On Channel EQ View

The channel EQ RTA function will always display the respective channel's frequency distribution, independent from the RTA Source definition. Use the EQ Overlay control for adjusting the amount of RTA on top of the EQ plot. Default preferences when opening any channel EQ view can be set to 'Pre-EQ' (off is Post-EQ) and 'Spectrograph' (off is bar graph). They can however be overruled on the respective EQ page.

## RTA On Graphic EQ View

The Graphic EQ RTA function will always display the respective FX slot's frequency distribution, independent from the RTA Source definition, unless the 'Use RTA Source' mark is ticked. Use the EQ Overlay control for adjusting the amount of RTA on top of the GEQ sliders. Default preferences when opening any GEQ view can be set to 'Post-GEQ' (off is pre-graphic EQ) and 'Spectrograph' (off is bar graph). They can however be overruled on the respective GEQ page.

## 2.3 Routing

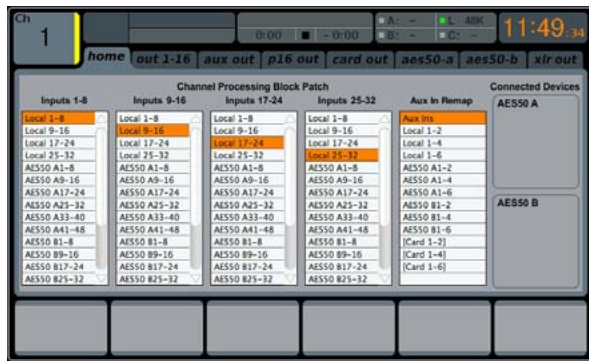

The **ROUTING** screen is where all signal patching is done, allowing you to route internal signal paths to and from the physical input/output connectors located on the M32's rear panel.

The **ROUTING** screen contains the following separate tabs:

**home:** Allows patching of physical inputs to the 32 input channels and auxiliary inputs of the console.

**out 1-16:** Allows patching of internal signal paths to the console's 16 rear-panel XLR outputs.

**aux out:** Allows patching of internal signal paths to the console's six rear-panel ¼"/RCA auxiliary outputs.

**p16 out:** Allows patching of internal signal paths to the 16 outputs of the console's 16-channel P16 Ultraset output.

**card out:** Allows patching of internal signal paths to the 32 outputs of the DN32-USB card.

**aes50-a:** Allows patching of internal signal paths to the 48 outputs of the rear-panel AES50-A output.

**aes50-b:** Allows patching of internal signal paths to the 48 outputs of the rear-panel AES50-B output.

**xlr out:** Allows patching of internal signal paths to the XLR out connections on the rear.

None of the **ROUTING** screen's tabs contain a secondary level of functions. When routing audio, the Up/Down navigation controls do not need to be used.

### home

The **ROUTING** screen's **home** tab allows the user to patch the M32's physical rear-panel inputs to the 32 input channels and auxiliary inputs of the console.

As a default, the M32 maps its 32 rear-panel analogue inputs to the respective 32 channel inputs that are accessed on input fader layers one and two, and maps the rear-panel line-level (auxiliary) inputs to the third input fader level.

However, the **home** tab of the **ROUTING** screen can be used to change this default assignment and cross-patch different physical inputs to different channel inputs, in banks of eight channels at a time. This allows the user to create a custom layer of channel inputs that differs from the order that the sources are plugged into the rear panel, and is easier than physically re-patching audio cables.

To assign various inputs to the M32's input channels, perform the following steps:

1. Adjust the first push encoder to select which 8-channel audio input source feeds input channels 1-8 of the console. As the control is rotated, the currently selected input will be highlighted in the vertical list of choices.
2. When the desired 8-channel source is selected, push the first push encoder to connect the currently selected 8-channel source. The selected source now feeds input channels 1-8 of the console.
3. Input choices that can be assigned include:
  - Local 1-8
  - Local 9-16
  - Local 17-24
  - Local 25-32
  - AES50-A 1-8
  - AES50-A 9-16
  - AES50-A 17-24
  - AES50-A 25-32
  - AES50-A 33-40
  - AES50-A 41-48
  - AES50-B 1-8
  - AES50-B 9-16
  - AES50-B 17-24
  - AES50-B 25-32
  - AES50-B 33-40
  - AES50-B 41-48
  - Card 1-8
  - Card 9-16
  - Card 17-24
  - Card 25-32.
4. To assign an 8-channel source from the other input channels of the console (9-16, 17-24, 25-32), simply repeat the process above, using the other four push encoders on the same screen.
5. Choices for Aux 1-4 include:
  - Aux Ins
  - Local 1-2
  - Local 1-4
  - Local 1-6

- AES50A 1-2
- AES50A 1-4
- AES50A 1-6
- AES50B 1-2
- AES50B 1-4
- AES50B 1-6
- Card 1-2
- Card 1-4
- Card 1-6.

### out 1-16

The **ROUTING** screens **out 1-16** tab allows the user to patch the M32's various internal signal paths to the 16 analogue XLR outputs that are located on the console's rear panel.

The M32 allows for many different kinds of output signal paths, and this screen is where these outputs are assigned to a physical rear panel output, so that the signal path can be patched to their eventual destination, such as front-of-house PA speakers or a powered stage monitor.

To assign the various output paths to the rear panel XLR outputs, perform the following steps:

1. Adjust the first push encoder to select to which of the 16 rear panel analogue outs you wish to assign an output signal path.
2. Adjust the third encoder to select an output path category. These include:
  - Off
  - Main (LRC) Mix
  - Mix Bus Outputs
  - Matrix Outputs
  - Direct Outs
  - Monitor.
3. Adjust the fourth encoder to select a specific output path, including:
  - Off
  - Main L
  - Main R
  - Main C/M
  - Any of the 16 Mix Outputs
  - Any of the six Matrix Outputs
  - Any of the 32 Direct Outputs
  - Any of the eight Auxiliary Outputs
  - Any of the FX Direct Outputs
  - Monitor L
  - Monitor R
  - Talkback.
4. Tap the fourth encoder to assign the selected output path, completing the process.
5. Adjust the fifth encoder to select the signal tap point for the output assignment. This determines where in the audio signal path the source is 'tapped' as it is sent to the physical rear panel output. The available signal tap points include:
  - IN/LC
  - IN/LC +M
  - PreEQ
  - PreEQ +M
  - PostEQ
  - PostEQ +M
  - PreFdr
  - PreFdr +M
  - Post Fader.

6. Tap the fifth encoder to assign the selected signal tap point.
7. Turn the sixth encoder to adjust the amount of digital line delay applied to the output path as it is sent to the rear panel physical output. As the amount of delay is adjusted, the current delay time is displayed in three different units of measurement: feet, metres and milliseconds.
8. Tap the sixth encoder to toggle delay on/off. The **Delay** label illuminates when the delay is inserted into the signal path.

**TIP:** Applying a delay to an output signal is typically done when the console is used in a 'multi-zone' PA speaker setup, where some PA speakers are located near the stage, and a second set of speakers is located further back within the audience. By applying an appropriate amount of delay only to the speakers located near the stage, the audience hears the audio from all speakers at the same time, ensuring maximum time-alignment and sound quality. The M32 assumes an operating temperature of 20°C/68°F when calculating the delay times.

### aux out

The **ROUTING** screen's **aux out** tab allows the user to patch an internal signal path (such as a mix output used as an effects send) to the six separate ¼"/RCA auxiliary outputs.

Since these six outputs can have a wide variety of signal paths assigned to them, they can be used for a wide variety of tasks, such as:

1. Feeding an external effects processor when the internal effects are insufficient.
2. Patching a specific console signal path to an outboard recorder.
3. Feeding the analogue or digital audio inputs of a nearby video recorder.

To make an assignment as described above, perform the following steps:

1. Adjust the first push encoder to select to which auxiliary outputs to assign a source. Choices include
  - Aux Out 1
  - Aux Out 2
  - Aux Out 3
  - Aux Out 4
  - Aux Out 5
  - Aux Out 6
  - AES/EBU (Digital) Out L
  - AES/EBU (Digital) Out R.
2. Adjust the third encoder to select for coarse range:
  - Insert
  - Main (LRC)
  - Mix Bus
  - Matrix
  - Direct Out
  - Monitor.
3. Adjust the fourth encoder to select a specific signal path to feed the selected physical output. Choices include:
  - Insert Point
  - Main L
  - Main R
  - Main C/M
  - Any of the 16 Mix Outputs
  - Any of the six Matrix Outputs

- Any of the 32 Direct Outputs
  - Any of the eight Auxiliary Outputs
  - Any of the FX Direct Outputs
  - Monitor L
  - Monitor R
  - Talkback.
4. Tap the fourth encoder to assign the selected output path, completing the process.
  5. Adjust the fifth encoder to select the signal tap point for the output assignment. Choices include:
    - IN/LC
    - IN/LC +M
    - PreEQ
    - PreEQ +M
    - PostEQ
    - PostEQ +M
    - PreFdr
    - PreFdr +M
    - Post Fader.
  6. Tap the fifth encoder to complete the signal tap point assignment.

### p16 out

The **ROUTING** screen's **p16 out** tab allows the user to route various console signal paths to the rear panel P16 Ultraset output. This output allows for 16 channels of audio to be sent, in digital form, to various accessories such as a personal monitoring distribution box.

Using the **p16 out** routing screen, the user can configure the P16 output to carry not only the main LR mix, but also various audio 'stems' of audio material sources from a bus send mix, such as a stereo drum mix, stereo keyboards, guitars, bass, vocals, etc. Musicians on stage would then be free to each craft their own personal mix of these musical stems, all delivered from the FOH position to stage over a single Ethernet cable.

To select which audio signals are sent to the P16 bus, perform the following steps:

1. Adjust the first push encoder to select for which of the 16 channels in the P16 bus you wish to select an audio source.
2. Adjust the third encoder to select a category of audio source to send to the currently selected P16 channel. These categories include:
  - Insert
  - Main (LRC)
  - Mix Bus
  - Matrix
  - Direct Out
  - Monitor.
3. Adjust the fourth encoder to select which specific signal path to feed to the currently selected P16 output. Choices include:
  - Off
  - Main L
  - Main R
  - Main C/M
  - Any of the 16 Mix Outputs
  - Any of the six Matrix Outputs
  - Any of the 32 Direct Outputs
  - Any of the eight Auxiliary Outputs
  - Any of the FX Direct Outputs

- Monitor L
  - Monitor R
  - Talkback.
4. Tap the fourth encoder to assign the selected output path, completing the process.
  5. Adjust the fifth encoder to select the signal tap point for the output assignment. This determines where in the audio signal path the source is 'tapped' as it is sent to the P16 output. The available signal tap points include:
    - IN/LC
    - IN/LC +M
    - PreEQ
    - PreEQ +M
    - PostEQ
    - PostEQ +M
    - PreFdr
    - PreFdr +M
    - Post Fader.
  6. Tap the fifth encoder to complete the signal tap point assignment.

### card out

The **ROUTING** screen's **card out** tab allows the user to patch various signal paths to the physical inputs and outputs on the DN32-USB card. The card's signal path provides 32 channels of inputs and 32 channels of outputs. The 32 card inputs can be used as alternative sources for the two input fader layers, switchable in banks of eight.

To assign an output path to the option card, perform the following steps:

1. Adjust the first push encoder to select an 8-channel signal path that will be sent to the first eight channels of the card. Choices include:
 

• Local 1-8	• AES50-B 25-32
• Local 9-16	• AES50-B 33-40
• Local 17-24	• AES50-B 41-48
• Local 25-32	• Card 1-8
• AES50-A 1-8	• Card 9-16
• AES50-A 9-16	• Card 17-24
• AES50-A 17-24	• Card 25-32
• AES50-A 25-32	• Out 1-8
• AES50-A 33-40	• Out 9-16
• AES50-A 41-48	• P16 1-8
• AES50-B 1-8	• P16 9-16
• AES50-B 9-16	• Aux 1-6/Mon.
• AES50-B 17-24	
2. Tap the first encoder to assign the selected output path, completing the process.
3. Repeat the process with encoders 2-4 to select output paths for the other 24 channels or card outputs.

### aes50-a / aes50-b

The **ROUTING** screens **aes50-a** and **aes50-b** tabs allow the user to patch various console output paths to the outputs of the dual AES50 connectors. These connectors can feed other AES50-equipped devices, such as a digital stage box or standalone multi-track recorder.

The M32 contains two separate AES50 connectors, labelled A and B. These dual connectors allow for an increased level of flexibility in networking the console to various AES50-based equipment.

Each of the two AES50 tabs contains the same following sets of parameters that can be adjusted. To assign various console signal paths to the AES50 connectors, perform the following steps:

- Adjust the first push encoder to select an 8-channel signal path that will be sent to the first eight channels of the AES50 connector's output. Choices include:
    - Local 1-8
    - Local 9-16
    - Local 17-24
    - Local 25-32
    - AES50-A 1-8
    - AES50-A 9-16
    - AES50-A 17-24
    - AES50-A 25-32
    - AES50-A 33-40
    - AES50-A 41-48
    - AES50-B 1-8
    - AES50-B 9-16
    - AES50-B 17-24
    - AES50-B 25-32
    - AES50-B 33-40
    - AES50-B 41-48
    - Card 1-8
    - Card 9-16
    - Card 17-24
    - Card 25-32
    - Card 1-8
    - Card 9-16
    - Card 17-24
    - Card 25-32
    - Out 1-8
    - Out 9-16
    - P16 1-8
    - P16 9-16
    - Aux 1-6/Mon.
  - Tap the first encoder to connect the currently selected signal path to the AES50 pathway.
  - Repeat the above process for the other five sets of 8-channel AES50 outputs.
- The **aes50-b** tab works exactly the same as the **aes50-a** tab, but instead selects sources sent to the output of the console's AES50-B connector.

### xlr out

The **ROUTING** screen's **xlr out** tab, much like the **out 1-16** tab, allows the user to patch the M32's various internal signal paths to the 16 analogue XLR outputs that are located on the console's rear panel. This tab, however, allows the XLR outputs to be patched in blocks of four, rather than individually. Also, on this screen it is only possible to route the signal to its absolute destination, rather than choosing the signal path. The available destinations will differ depending on the block selected. Destinations include:

#### Block 1-4 / Block 9-12

- Local 1-4
- Local 9-12
- Local 17-20
- Local 25-28
- AES50-A 1-4
- AES50-A 9-12
- AES50-A 17-20
- AES50-A 25-28
- AES50-A 33-36
- AES50-A 41-44
- AES50-B 1-4
- AES50-B 9-12
- AES50-B 17-20

#### Block 5-8 / Block 13-16

- Local 5-8
- Local 13-16
- Local 21-24
- Local 29-32
- AES50-A 5-8
- AES50-A 13-16
- AES50-A 21-24
- AES50-A 29-32
- AES50-A 37-40
- AES50-A 45-48
- AES50-B 5-8
- AES50-B 13-16
- AES50-B 21-24

- AES50-B 25-28
- AES50-B 33-36
- AES50-B 41-44
- Card 1-4
- Card 9-12
- Card 17-20
- Card 25-28
- Out 1-4
- Out 9-12
- P16 1-4
- P16 9-12
- Aux 1-4
- Auxin 1-4.
- AES50-B 29-32
- AES50-B 37-40
- AES50-B 45-48
- Card 5-8
- Card 13-16
- Card 21-24
- Card 29-32
- Out 5-8
- Out 13-16
- P16 4-8
- P16 13-16
- Aux 5-6/Mon
- Auxin 5-6/TB.

## 2.4 Setup

The **SETUP** screen offers various controls for global, high-level functions of the M32, such as display adjustments, sample rates and synchronisation, user settings, and network configuration.

The **SETUP** screen contains the following separate tabs:

**global:** This screen offers adjustments for various global preferences of how the console operates.

**config:** This screen offers adjustments for sample rates and synchronisation, as well as configuring high-level settings for signal path buses.

**remote:** This screen offers different controls for setting up the console as a control surface for various DAW recording software packages on a connected computer.

**network:** This screen offers different controls for attaching the console to a standard Ethernet network.

**scribble strips:** This screen offers controls for various aspects of the console's DCA groups.

**preamps:** This screen allows the gain on each of the individual input channels' preamps to be adjusted.

**card:** This screen selects the input/output configuration.

None of the **SETUP** screen's tabs contain a secondary level of functionality, so the UP/DOWN navigation controls do not need to be used for these screens.

### global



The **SETUP** screen's **global** tab allows the user to adjust various global controls of the console, such as display brightness and contrast, the panning mode used by channels, text languages, and more.

To make adjustments to the global screen, perform the following steps:

1. Adjust the first push encoder to select various console settings for pop-up messages and assorted preferences.
2. Tap the first encoder to turn the currently selected setting on or off.
3. Adjust the second encoder to select settings for linked console channels.
4. Tap the second encoder to turn the currently selected setting on or off.
5. Adjust the third encoder to set the console's panning mode, which affects how channel panning is performed in the stereo field. The two choices are:
  - LR+M: This is the default mode of the console. In this mode, channels can be panned between left and right mix outputs, as well as assigned to the separate mono mix bus. In this mode the Centre/Mono bus is not affected by the pan control
  - LCR: In this mode, the signal is panned from left to right. This behaviour is emulated by the faders on the Main tab, which is more intuitive than on other consoles. Note that in this mode, the definition of 'mono' changes, since the setup is no longer mono, but rather a setup consisting of Left/Centre/Right
6. CUE: / SCN: / SNP: Toggle between these settings to control which of the three is displayed on the external editing software.
7. Adjust the fourth encoder to set the brightness of the various LED lights on the M32, within a range of 1-100.
8. Adjust the fifth encoder to set the brightness of the Main Display, within a range of 1-100.
9. Adjust the sixth encoder to set the contrast of the individual LCD screens (channel display) above each input and output channel, within a range of 1-100.

## config



The **SETUP** screen's **config** tab allows adjustment of various audio-related settings, such as the console's base sample rate and use of an internal or external digital clock. It also offers choices for high-level global settings for how signal path buses operate.

To adjust the various settings of the **config** tab, perform the following steps:

1. Adjust the first push encoder to select between Console, Show Data, and Libraries for initialisation.
2. Tap the first encoder to initialise the console back to its factory state.
  - The message, "Do you really want to initialize ALL settings?" will appear. Use the Left navigation control to cancel the operation, or the Right navigation control to confirm.
3. The console's current firmware version is displayed in the first column of the Main Display.
  - If/when a firmware update is available for the console, the user simply needs to download the new firmware file to the root level of a USB stick. The USB button has to be pressed while booting up, and when the console displays "waiting for USB" on the main screen insert the USB stick.

4. Adjust the second encoder to select the digital sample rate of the console. Choices include:
  - 44.1 kHz
  - 48 kHz.
5. Tap the second encoder to assign the currently selected sample rate.
 

**TIP:** Note that the sample rate of the console will be the same sample rate for any audio recorded to the onboard stereo USB recorder, as well as the sample rate output by the AES/EBU connector that may get patched into an outboard recorder. Thus, it is often beneficial to select a sample rate that is appropriate for the medium on which the recorded audio will be used.

If the programme material being recorded is audio only with no video component, it usually makes sense to set a sample rate of 44.1 kHz. This will ensure that any audio that is recorded is compatible with the 44.1 kHz sample rate of commercial audio CDs.

If the programme material being recorded is audio that is meant to accompany video, it makes sense to set a sample rate of 48 kHz. This will ensure that any audio recorded is compatible with the 48 kHz sample rate of the various audio formats used on a video DVD.
6. Adjust the third encoder to set the word clock synchronisation of the console to its internal digital clock, or slave to an external digital clock. Choices for the clock signal include:
  - Internal clock
  - External clock from the AES50-A port
  - External clock from the AES50-B port
  - Card.

Note that the graphics at the top of the screen will always display a green LED when the console has achieved proper 'digital lock', from either its own internal clock or a valid external clock.

7. Tap the fourth encoder to cycle through the different settings for the console's internal date and time settings.
8. Adjust the fourth encoder to set the value for the currently selected date/time setting.
9. Adjust the fifth encoder to select the console's 'Bus Pre-Configuration'. This setting allows the mix bus outputs to be configured in various combinations of:
  - Pre-fader, variable output auxiliary sends
  - Fixed-output subgroups
  - Post-fader, variable output auxiliary sends.

Choices include:

- Eight pre-fader auxiliary sends, eight post-fader auxiliary sends, no subgroups
  - Eight pre-fader auxiliary sends, four post-fader auxiliary sends, four subgroups
  - Six pre-fader auxiliary sends, four post-fader auxiliary sends, six subgroups
  - Four pre-fader auxiliary sends, four post-fader auxiliary sends, eight subgroups
  - Ten pre-fader auxiliary sends, six post-fader auxiliary sends, no subgroups.
10. Tap the fifth encoder to assign the currently selected configuration.
 

As the configuration is selected, a display on the right-hand side of the Main Display changes to show the currently selected configuration.

## remote



The **SETUP** screen's **remote** tab allows the M32 to be set up as a control surface for various DAW recording software on a connected computer. With its large complement of motorised faders, the console can act as an excellent controller, allowing the user to make level adjustments quickly and easily without using a mouse.

To adjust the various remote settings, perform the following steps:

- Tap the first push encoder to enable the M32's **REM - DAW REMOTE** button on the control surface. This switches various console hardware, such as the bus faders, to control computer DAW software instead of the console's internal audio path.
- Adjust the second encoder to select the specific control surface protocol used, in conjunction with the target DAW software. Choices include:
  - Mackie Ctrl:** Use this protocol to control any DAW software that is compatible with a Mackie Control hardware surface
  - HUI:** Use this protocol to control any DAW software that is compatible with an HUI hardware control surface, such as Pro Tools
  - Midi CC:** Use this protocol to control software via MIDI. More detailed information can be found in Appendix B: MIDI Operation.
- Tap the second encoder to assign the currently selected control surface protocol.
- Adjust the fifth encoder to select whether the remote function uses the MIDI IN and MIDI OUT sockets, the card's MIDI, or RTP (Real Time Protocol) MIDI.
- Tap the fifth encoder to confirm the selection.
- Turn the sixth encoder to adjust various MIDI-based operations for the console. Choices include:
  - MIDI In/Out:** This toggles the MIDI input and output on or off
  - Card MIDI:** Allows MIDI transmission through the DN32-USB card
  - RTP (Real-Time Transport Protocol):** This toggles on or off the console's ability to interface with an Ethernet-based MIDI system
  - Rx PrgC:** Toggles on or off the console's ability to receive Program Change messages
  - Tx PrgC:** Toggles on or off the console's ability to send Program Change messages
  - Rx Fader:** Toggles on or off the console's ability to receive Fader messages
  - Tx Fader:** Toggles on or off the console's ability to send Fader messages
  - Rx Mute:** Toggles on or off the console's ability to receive Mute messages
  - Tx Mute:** Toggles on or off the console's ability to send Mute messages
  - Rx Pan:** Toggles on or off the console's ability to receive Pan messages
  - Tx Pan:** Toggles on or off the console's ability to send Pan messages
  - X/OSC:** Open Sound Control, toggles on or off the console's ability to communicate with the iPad application.

- Tap the sixth encoder to toggle the currently selected MIDI option on or off. This can be useful if you want to ensure that any connected MIDI transmitters cannot interfere with the console.

**NOTE:** For more detailed information about MIDI, see **Appendix B: MIDI Operation**.

## network



The **SETUP** screen's **network** tab contains settings used when connecting the M32 to a standard Ethernet network. The user can set parameters such as using a fixed IP address, or having one assigned, as well as setting up Ethernet and subnet mask settings.

To set the network address for the console, perform the following steps:

- Adjust the first push encoder to select which specific network field to adjust. Choices include:
  - IP address
  - Subnet Mask
  - Gateway.
- Adjust encoders 2, 3, 4 and 5 to set the four numerical fields to be adjusted for the selected network field.
- Tap the sixth encoder to assign the adjusted settings.

## scribble strip

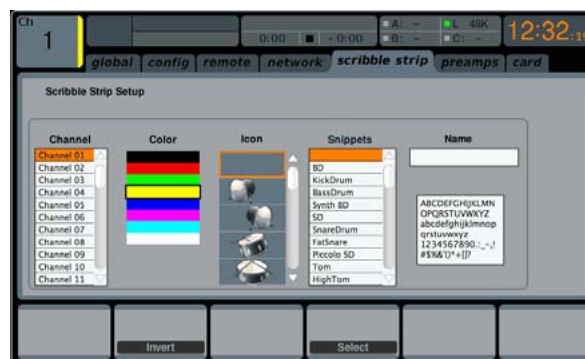

The **SETUP** screen's **scribble strips** tab allows customisation for all of the M32's channel LCD displays, including Aux, FX, Buses, Matrices and DCAs.

On the **scribble strips** tab the user can make useful adjustments, such as assigning real names to the selected channel (such as 'drums' or 'backing vocals'), as well as assigning colours to them that are then reflected on the console's channel LCD screens.

To adjust the various LCD display settings, perform the following steps:

- Adjust the first push encoder to select which of the channels you wish to edit.
- Adjust the second encoder to set the colour for the currently selected channel's scribble strip.

- Tap the second encoder to invert the colour.
- Adjust the third encoder to select the graphic icon for the selected channel. A large variety of clip-art is available to represent various input sources and output destinations.
- Adjust the fourth encoder to select a name from a list of common preset names (snippets) for the currently selected channel.
- Tap the fourth encoder to assign the currently highlighted text to the currently selected channel's scribble strip.
- Tap the fifth encoder to edit the text assigned to the currently selected channel's scribble strip.
- Adjust the fifth encoder to scroll through the available characters that can be used to name the currently selected channel's scribble strip.
- Tap the fifth encoder to select the currently highlighted character.
- Adjust the sixth encoder to scroll between the available character sets.
- Tap the sixth encoder to exit the text editor and save the current parameters to the currently selected channel's scribble strip.

### preamps



This screen allows controlling all accessible preamps from the console, including local and AES50 remote preamps, irrespective of any console's channel assignments. The UP/DOWN navigation buttons switch between the two layers of preamps. Pressing the push encoders will activate the phantom power. Turning the first push encoder will select from the banks of eight, pressing it will confirm the selection.

### card

This screen selects the input/output configuration. Use the second push encoder to select between the following presets:

- 32in / 32out
- 16in / 16out
- 32in / 8out
- 8in / 32out
- 8in / 8out
- 2in / 2out.

## 2.5 Library



The **LIBRARY** screen allows loading and saving of commonly used setups for the channel inputs, effects processors and routing scenarios.

The **LIBRARY** screen contains the following separate tabs:

**channel:** This tab allows the user to load and save commonly used combinations of the channel DSP effects.

**effects:** This tab allows the user to load and save commonly used effects processor presets.

**routing:** This tab allows the user to load and save commonly used signal routings.

### channel

The **LIBRARY** screen's **channel** tab allows you to load and save commonly used combinations of the channel DSP effects. For example, once you have dialled in a combination of EQ and compression that works well for a particular singer, you can save the channel DSP chain as a preset for later recall.

To adjust the various settings on the **channel** tab, perform the following steps:

- Adjust the first push encoder to select which specific elements of the input channel can be recalled when loading an input channel preset. Choices include:
  - Head Amp (Microphone Preamplifier)
  - Configuration
  - Gate
  - Compressor
  - Equalizer
  - Sends.
- Tap the first encoder to turn the currently selected element on or off in the recall list.
- Adjust the second encoder to scroll among a list of input channel presets.
- Tap the second encoder to load the currently highlighted preset and make it active on the currently selected console channel.
- Adjust the third encoder to scroll among a list of channel preset slots to save the current state of the currently selected console channel.
- Tap the third encoder to save the currently selected channel's state to the currently selected preset slot.
  - When the third encoder is tapped, a preset naming screen appears. Adjust and tap encoders 4-6 to apply a custom name to the preset before saving it, then tap the sixth encoder to complete the save process.
- Tap the fourth encoder to delete a preset from the currently highlighted preset slot.

## effects

The **LIBRARY** screen's **effects** tab allows you to load and save presets for the various onboard effects processors.

To adjust the various settings on the **effects** tab, perform the following steps:

- Adjust the first push encoder to select which of the eight effects slots to load or save a preset.
  - As you navigate among the eight effects slots the specific effect processor loaded into each slot will display on the screen as both a name and an icon.
- To save and load presets, as well as import/export them, follow the same procedure as detailed in the **LIBRARY** screen **channel** tab.

## routing

The **LIBRARY** screen's **routing** tab allows you to load and save presets of the M32's signal routings. This can be useful for repeating specific routing scenarios that occur over and over on a regular basis, such as when using the console for a weekly club gig or worship service.

To adjust the various settings on the **routing** tab, perform the following steps:

- Adjust the first push encoder to select which specific console signal paths will be recalled when loading a routing preset. Choices include:
  - Channel Inputs
  - Analog Out
  - Auxiliary Out
  - P16 (Ultranet) Out
  - Card Out
  - AES50 Out.
- Tap the first encoder to turn the currently selected element on or off in the recall list.
- To save and load presets, as well as import/export them, follow the same procedure as detailed in the **LIBRARY** screen **channel** tab.

## 2.6 Effects

The **EFFECTS** screen controls various aspects of the eight internal effects processors. On this screen the user can select specific types of effects for the eight internal processors, configure their input and output paths, monitor their levels, and adjust the various effect parameters.

The first four slots can be Insert and Side-Chain effects, and the slots five to eight are Insert only. Additionally these slots can only hold some effects excluding reverbs and other power-intensive effects. They also have different selections for the input sources.

The **EFFECTS** screen contains the following separate tabs:

**home:** The home tab provides a general overview for all eight effects processors, displaying what effect has been inserted in each of the eight slots, as well as displaying input/output paths for each slot, and the I/O signal levels.

**fx1-8:** These eight duplicate screens display all relevant data for the right separate effects processors, allowing the user to adjust all parameters for the selected effect.

## home



The **EFFECTS** screen's **home** tab provides a high-level overview of the eight effects processor slots, giving the user at-a-glance feedback on the effects they have assigned to the slots, the console source and destination for each processor, and the input/output levels for each processor.

To make adjustments on the **EFFECTS** screen's **home** tab, perform the following steps:

- Adjust the first push encoder to select the input source for the currently highlighted effects block. Signal path choices include:
  - Insert Send
  - Mix Bus 1-16.
- Tap the first encoder to assign the currently selected input source.
- Adjust the second encoder to select the input source for the right side of the currently highlighted effects block.
- Tap the second encoder to assign the currently selected input source.
 

**TIP:** To configure an effect as mono input and stereo output, set both input sources to the same signal path
- Tap the third and fourth encoders to mute the currently selected effect.
- Adjust the fifth encoder to scroll among the different audio effects available. Choices include:

Hall Reverb	Delay + Chamber	M/S Fair Comp
Ambience	Chorus + Chamber	Dual Fair Comp
Rich Plate Reverb	Flanger + Chamber	Leisure Comp
Room Reverb	Delay + Chorus	Dual Leisure Comp
Chamber Reverb	Delay + Flanger	Ultimo Comp
Plate Reverb	Modulation Delay	Dual Ultimo Comp
Vintage Reverb	Dual Graphic EQ	Dual Enhancer
Vintage Room	Stereo Graphic EQ	Stereo Enhancer
Gated Reverb	Dual TruEQ	Dual Exciter
Reverse Reverb	Stereo TruEQ	Stereo Exciter
Stereo Delay	Dual DeEsser	Stereo Imager
Triple Delay	Stereo DeEsser	Edison EX1
Rhythm Delay	Stereo Xtec EQ1	Sound Maxer
Stereo Chorus	Dual Xtec EQ1	Dual Guitar Amp



Stereo Flanger	Stereo Xtec EQ5	Stereo Guitar Amp
Stereo Phaser	Dual Xtec EQ5	Dual Tube Stage
Dimension-C	Wave Designer	Stereo Tube Stage
Mood Filter	Precision Limiter	Dual Pitch Shifter
Rotary Speaker	Combinator	Stereo Pitch
Tremolo / Panner	Dual Combinator	
Suboctaver	Fair Comp	

- Tap the fifth encoder to assign the selected effect to the currently highlighted effects slot.
- Adjust the sixth encoder to scroll among the eight effects slots to select one for editing.
- Tap the sixth encoder to go to the edit page for the currently highlighted effects slot.

### fx1-8

The **EFFECTS** screen's **fx 1-8** tabs allow you to edit the parameters for the specific effect processor assigned to the corresponding effects slot.

In order to more closely simulate the look and feel of the outboard processors that are no longer necessary with a digital console, the individual effects processor screen provides a graphical representation of the effects processor's real world physical counterpart. This provides greater ease of use for the user than a simple text list of parameters.

To make adjustments on the **EFFECTS** screen's editing tab, perform the following steps:

- Adjust the six push encoders to change the various effects parameters shown at the bottom of the screen.
- Use the Up/Down navigation controls to switch the push encoders to a second, third or fourth set of parameters for effects that contain more than six adjustable parameters.
- When the effects processor has been edited to your satisfaction, push the sixth encoder to go back to the **EFFECTS** screen's **home** tab.
- See the **Main Display - Internal Effects** section for more details on specific effects and parameters.

**TIP:** For the *Graphics EQ* effects, tap the first push encoder to implement the 'Graphics EQ on Faders' function. This allows you to boost or cut the different EQ bands using the eight console output faders, eight faders at a time, with the relevant EQ bands displayed on the channel LCD screens.

## 2.7 Mute Group

The M32's **MUTE GRP** screen allows for quick assignments and control of the console's six mute groups, and offers two separate functions:

- It mutes the active screen during the process of assigning channels to mute groups. This ensures that no channels are accidentally muted during the assignment process of a live performance.
- It offers an additional interface for muting or unmuting the mute groups in addition to the dedicated mute group buttons on the console's control surface.

When activated, the **MUTE GRP** screen only covers the bottom portion of the Main Display, allowing the middle portion to continue displaying its usual screen content.

To assign channels to one of the six mute groups, perform the following steps:

- Press the **MUTE GRP** button to switch the Main Display to the mute groups view.
- Press and hold the desired mute group button (1-6) on the lower right-hand corner of the console.

- While holding the mute group button, press the SEL button on any input or output channel, on any layer, that you wish to assign to the mute group.
- When you have assigned all the desired channels to the mute group, release the dedicated mute group button. The individual channel **MUTE** buttons will resume their normal function.

To use the **MUTE GRP** screen to mute or unmute the groups, perform the following steps:

- Tap any of the six push encoders to mute the corresponding group, and thus mute all channels that are assigned to that mute group.
- Tap the encoder of a currently mute group to unmute that group.
- When finished working with mute groups, tap the **MUTE GRP** button to exit the screen. The Main Display will again show its full set of controls for the current page.

## 2.8 Utility

The **UTILITY** screen is a supplemental screen designed to work in conjunction with the other screens that may be in view at any particular moment.

The **UTILITY** screen is never seen by itself; it always exists in the context of another screen.

To reinforce this point, when the **UTILITY** screen selection button is pressed, it illuminates at the same time that another screen selection button is illuminated, showing you for which screen it is providing other utilities. For most screens, pressing the **UTILITY** button simply acts as a short cut to a page that can be navigated to by other means. In a few cases, a utility page provides extra functionality not seen anywhere else.

The **UTILITY** screen selection button works in the following manner with other screens on the console:

### HOME Screen

Pressing the **UTILITY** button while on any of the tabs on the **HOME** page will take the user to the **channel** tab of the **LIBRARY** screen.

### METERS Screen

There are no Utility functions on any of the **METERS** screen's tabs.

### ROUTING Screen

Pressing the **UTILITY** button while on any of the **ROUTING** screen's tabs takes the user to the **routing** tab of the **LIBRARY** screen.

### SETUP Screen

With the exception of the **scribble strips** tab, there are no Utility functions on any of the **SETUP** screen's tabs.

For the **scribble strips** tab, pressing the **UTILITY** button provides an interface for assigning a custom colour, name and icon to the currently selected input or output channel.

- Adjust and tap the six push encoders to assign a colour, name and icon to the currently selected input or output channel. Tap the sixth encoder to save changes and exit.

### LIBRARY Screen

There are no Utility functions on any of the **LIBRARY** screen's tabs.

### EFFECTS Screen

Pressing the **UTILITY** button while on any of the **EFFECTS** screen's tabs takes the user directly to the **effects** tab of the **LIBRARY** screen.

### RECORDER Screen

Pressing the **UTILITY** button while on either of the **RECORDER** screen's tabs takes the user directly to the **select USB drive folder/file** page of the **RECORDER** screen's **config** tab.

## MONITOR Screen

There are no Utility functions on any of the **MONITOR** screen's tabs.

## TALKBACK Screen

There are no Utility functions on any of the **TALKBACK** screen's tabs.

## SHOW CONTROL Screen

Pressing the **UTILITY** button while on any of the **SCENES** screen's tabs provides an interface for copying, pasting, loading and saving different scenes in the scene list. Adjust and tap the six push encoders to perform these functions. More information can be found in the **SHOW CONTROL** section.

## ASSIGN Screen

There are no Utility functions on any of the **ASSIGN** screen's tabs.

## 2.9 Internal Effects



The M32 contains over 60 internal effects that can be applied to each of the input channels, either as inserts or as sends and returns. Access the internal effects by pressing the **EFFECTS** button next to the Main Display. The functionality for each of the effects is detailed below.

### Hall Reverb

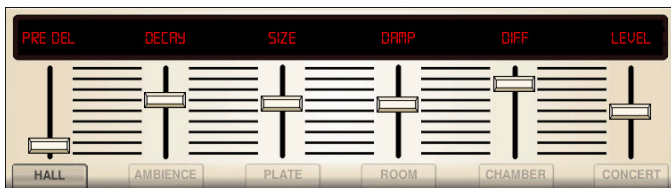

Classic Hall Reverb simulates the reverberation that occurs when sound is recorded in medium- to large-sized concert halls. Use the Hall Reverb to give your mix a lush, three-dimensional quality that will make your performance sound larger than life. *Inspired by the Lexicon Hall.*

The **PRE DELAY** slider controls the amount of time before the reverberation is heard following the source signal. **DECAY** controls the amount of time it takes for the reverb to dissipate. **SIZE** controls the perceived size of the space being created by the reverb effect. The **DAMP** slider adjusts the decay of high frequencies within the reverb tail. **DIFF**(usion) controls the initial reflection density. **SHAPE** adjust the contour of the reverberation envelope.

**LO CUT** and **HI CUT** function as Low- and High-Cut filters. **BASSMULT** multiplies the bass frequencies and **MOD SPEED** adjusts the speed of the effect's modulation. **SHAPE** adjust the contour of the reverberation envelope.

### Ambience



Ambience creates a customisable virtual acoustic space in which to place the elements of a mix. Use Ambience to add warmth and depth without colouring the direct sound. *Inspired by the Lexicon Ambience Algorithm.*

**PRE DELAY** sets the time before the reverb follows the source signal. **DECAY** adjusts the time it takes for the reverb to completely dissipate. **SIZE** controls the room size emulation. **DAMPING** controls the high-frequency decay within the reverb tail. **DIFFUSE** controls the initial echo density. The level sets the volume output of the affected signal. **LO CUT** affects the low frequency cut, allowing lower frequencies to remain unaffected by the reverb. **HI CUT** affects the high frequency cut, allowing higher frequencies to remain unaffected by the reverb. **MOD** adjusts the level of reverb decay modulation. **TAIL GAIN** adjusts the volume of the reverb tail.

### Rich Plate Reverb



Rich Plate Reverb was originally created by sending a signal through a transducer to create vibrations on a plate of sheet metal which were then picked up as an audio signal. Our algorithm simulates that sound with high initial diffusion and a bright-coloured sound. *Inspired by the Lexicon Plate Reverb.*

The **PRE DELAY** slider controls the amount of time before the reverberation is heard following the source signal. **DECAY** controls the amount of time it takes for the reverb to dissipate. **SIZE** controls the perceived size of the space being created by the reverb effect. The **DAMP** slider adjust the decay of high frequencies within the reverb tail. **DIFF**(usion) controls the initial reflection density.

**LO CUT** and **HI CUT** function as Low- and High-Cut filters. **BASSMULT** multiplies the bass frequencies and **MOD SPEED** adjusts the speed of the effect's modulation. **SHAPE** adjust the contour of the reverberation envelope.

The **SPIN** parameter sets the amount of random modulation for the reverb tail. The parameters **Echo / EchoFeed** set the parameters of a feedback delay at the input of the reverb (independent for both input channels). **Echo** sets the delaytime and **EchoFeed** the amount of feedback (positive or negative). This allows to further increase the reflection density of the reverb.

### Room Reverb

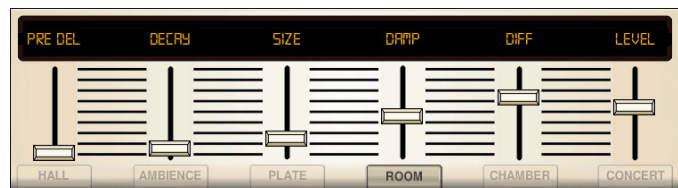

Room Reverb simulates the reverberation that occurs when sound is recorded in a small room. When you want to add a bit of warmth and just a touch of reverb, the M32's Vintage Room breathes life into close-miked guitar and drum tracks. *Inspired by the Lexicon Room Reverb.*

The **PRE DELAY** slider controls the amount of time before the reverberation is heard following the source signal. **DECAY** controls the amount of time it takes for the reverb to dissipate. **SIZE** controls the perceived size of the space being created by the reverb effect. The **DAMP** slider adjust the decay of high frequencies within the reverb tail. **DIFF**(usion) controls the initial reflection density. **SHAPE** adjust the contour of the reverberation envelope.

### Chamber Reverb

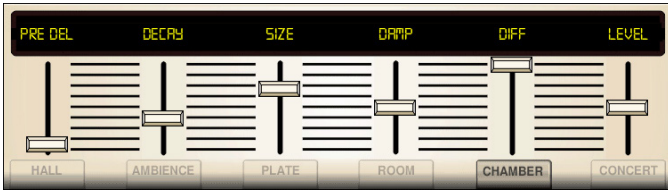

Chamber Reverb simulates the reverberation found in medium sized spaces, somewhere between the intimacy of a small room, and the grandeur of a large hall. *Inspired by the Lexicon Chamber Reverb.*

The **PRE DELAY** slider controls the amount of time before the reverberation is heard following the source signal. **DECAY** controls the amount of time it takes for the reverb to dissipate. **SIZE** controls the perceived size of the space being created by the reverb effect. The **DAMP** slider adjust the decay of high frequencies within the reverb tail. **DIFF**(usion) controls the initial reflection density. **SHAPE** adjust the contour of the reverberation envelope.

### Plate Reverb



A plate reverb was originally created by sending a signal through a transducer to create vibrations on a plate of sheet metal which were then picked up as an audio signal. Our algorithm simulates that sound with high initial diffusion and a bright-coloured sound. The M32's Plate Reverb will give your tracks the sound heard on countless hit records since the late 1950s. *Inspired by the Lexicon PCM-70.*

**PRE DELAY** controls the amount of time before the reverberation is heard following the source signal. **DECAY** controls the amount of time it takes for the reverb to dissipate. **SIZE** adjusts the size of the virtual room created by the reverb effect. The **DAMP** push encoder adjusts the decay of high frequencies within the reverb tail. **DIFF**(usion) controls the initial reflection density. **LEVEL** controls the volume of the reverb.

The **LO CUT** push encoder sets the frequency beneath which the source signal will not pass through the reverb. The **HI CUT** push encoder sets the frequency above which the source signal will not pass through the reverb. **BASS MULT**(iplier) push encoder adjusts the decay time of the bass frequencies. **XOVER** controls the crossover point for bass. **MOD DEPTH** controls the intensity of the reverb tail modulation. **MOD SPEED** controls the speed of the reverb tail modulation.

### Vintage Reverb



Based on the legendary EMT250, the M32's Vintage Reverb delivers shimmering, bright reverb that won't drown out or overpower your live or recorded tracks. Use Vintage Reverb to sweeten vocals and snare drums without sacrificing clarity.

When Layer 1 is selected, the first slider on the left sets the reverb time from 4 milliseconds to 4.5 seconds. Slider 2 controls the low-frequency multiplier decay time. Slider 3 controls the high-frequency multiplier decay time. Slider 4 controls the amount of modulation in the reverb tail. When Layer 2 is selected, slider 1 adjusts the pre-delay. Slider 2 selects the low-cut frequency. Slider 3 selects the hi-cut frequency. Slider 4 selects adjusts the output level of the reverb.

Pressing the first push encoder on Layer 1 will switch the reverb algorithm to emulate the perceived position of the reverb in the virtual space. The same control on Layer 2 will change the reverb algorithm to give a warmer, more 'vintage' sound.

### Vintage Room



Vintage Room simulates the reverberation that occurs when sound is recorded in a small room. When you want to add a bit of warmth and just a touch of reverb, the M32's Vintage Room breathes life into close-miked guitar and drum tracks. *Inspired by the Quantec QRS.*

The VU meter displays the input and output levels. Set the early reflection times for the left and right channel with **ER DELAY L** and **ER DELAY R**. **ER LEVEL** sets the loudness of the early reflection level. **REV DELAY** controls the amount of time before the reverberation is heard following the source signal. **LEVEL** controls the volume of the reverb. Pressing the second push encoder will engage the **FREEZE** function which takes the incoming audio and loops it indefinitely.

**HI/LO MULTIPLY** adjusts the decay time of the high and bass frequencies. **DECAY** shows the duration of the reverb effect. **ROOM SIZE** adjusts the size of the room effect being created incrementally from small to large. **HIGH CUT** sets the frequency above which the source signal does not pass through the reverb. **DENSITY** manipulates the reflection density in the simulated room. (This slightly changes the reverb decay time.) **LOW CUT** sets the frequency below which the source signal does not pass through the reverb.

### Gated Reverb



This effect was originally achieved by combining a reverb with a noise gate. Our gated reverb creates the same impression by a special shaping of the reverb tail. Gated Reverb is especially effective for creating a 1980's-style snare sound, or to enlarge the presence of a kick drum. *Inspired by the Lexicon 300/480L.*

**PRE DELAY** controls the amount of time before the reverberation is heard following the source signal. **DECAY** controls the amount of time it takes for the reverb to dissipate. **ATTACK** controls how fast the reflection density builds up. **DENSITY** shapes the reverb decay tail. The higher the density, the greater the number of sound reflections. **SPREAD** controls how the reflection is distributed through the reverb envelope. **LEVEL** controls the volume of the reverb. The **LO CUT** push encoder sets the frequency beneath which the source signal will not pass through the reverb. **HiSVFr / HiSVGn** push encoders adjust a high-shelving filter and the input of the reverb effect. **DIFF(usion)** controls the initial reflection density.

## Reverse Reverb



Reverse Reverb takes the trail of a reverb, turns it around, and places it in front of the sound source.. Use the swelling crescendo of the Reverse Reverb to add an ethereal quality to vocal and snare drum tracks. *Inspired by the Lexicon 300/480L.*

Adjusting the **PRE DELAY** push encoder adds up to 200 milliseconds before the reverb follows the source signal. The **DECAY** push encoder adjusts the time it takes for the reverb to completely dissipate. **RISE** controls how quickly the effect builds up. **DIFF(usion)** controls the initial reflection density. **SPREAD** controls how the reflection is distributed through the reverb envelope. The **LO CUT** push encoder sets the frequency beneath which the source signal will not pass through the reverb. **HiSVFr / HiSVGn** push encoders adjust a high-shelving filter and the input of the reverb effect.

## Stereo Delay

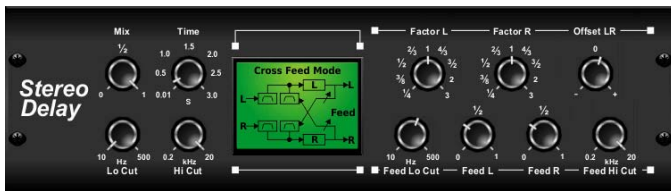

Stereo Delay provides independent control of left and right delay (echo) times, and features high- and low-pass filters for enhanced tone-shaping of the delayed signals. Use the Stereo Delay to give your mono signals a wide presence in the stereo field.

The **MIX** control lets you blend the source signal and the delayed signal. **TIME** adjusts the master delay time up to three seconds. **LO CUT** adjusts the low frequency cut, allowing lower frequencies to remain unaffected by the delay. **HI CUT** adjusts the high frequency cut, allowing higher frequencies to remain unaffected by the delay. **FACTOR L** sets the delay time on the left channel to rhythmic fractions of the master delay time. **FACTOR R** sets the delay time on the right channel to rhythmic fractions of the master delay time. **OFFSET LR** adds a delay difference between the left and right delayed signals. The **FEED LO CUT/ HI CUT** adjusts filters in the feedback paths. **FEED L** and **FEED R** control the amount of feedback for the left and right channels. **MODE** selects the feedback mode:

- **ST** sets normal feedback for both channels
- **X** crosses feedback between left and right channels
- **M** creates a mono mix within the feedback chain.

## Triple Delay



Sometimes called a 3-Tap Delay, the Triple Delay provides three delay stages with independent frequency, gain and pan controls. Create time-based echo effects with the triple delay to increase the sense of stereo separation.

**TIME** sets the master delay time, which is also the delay time for the first stage. **GAIN BASE** sets the gain level of the first stage of the delay. **PAN BASE** sets the position of the first delay stage in the stereo field. **LO CUT** sets the frequency at which the source signal can begin passing through the delay. **HI CUT** sets the frequency at which the source signal can no longer pass through the delay. **X-FEED** indicates that stereo cross-feedback of the delayed signals is active. **MONO** activates a mono mix of both channels for the delay input. **FEEDBACK** adjusts the amount of feedback.

**FACTOR A** controls the amount of delay time in the second stage of the delay. **GAIN A** controls the gain in the second stage of the delay. **PAN A** sets the position of the second stage of the delay in the stereo field. **FACTOR B** controls the amount of delay time in the third stage of the delay. **GAIN B** controls the gain in the third stage of the delay. **PAN B** sets the position of the third stage of the delay in the stereo field.

## Rhythm Delay



The Rhythm Delay, or 4-Tap Delay, provides four delay stages with independent frequency, gain and pan controls. Create time-based echo effects with the triple delay to increase the sense of stereo separation.

**TIME** sets the master delay time, which is also the delay time for the first stage. **GAIN BASE** sets the gain level of the first stage of the delay. **LO CUT** sets the frequency at which the source signal can begin passing through the delay. **HI CUT** sets the frequency at which the source signal can no longer pass through the delay. **X-FEED** indicates that stereo cross-feedback of the delayed signals is active. **MONO** activates a mono mix of both channels for the delay input. **FEEDBACK** adjusts the amount of feedback. **SPREAD** adjusts the perceived stereo placing of the echoes.

**FACTOR A** controls the amount of delay time in the second stage of the delay. **GAIN A** controls the gain in the second stage of the delay. **FACTOR B** controls the amount of delay time in the third stage of the delay. **GAIN B** controls the gain in the third stage of the delay. **FACTOR C** controls the amount of delay time in the fourth stage of the delay. **GAIN C** controls the gain in the fourth stage of the delay.

## Stereo Chorus



Chorus samples the input, slightly detunes it and mixes it with the original signal to produce a somewhat thicker, shimmering sound. Use it to thicken up background vocals, or to double the sound of brass and woodwind instruments.

Whereas **DELAY L / R** set the total amount of delay for the left and right channels, **WIDTH L / R** determines the amount of modulated delay taken from either the left or right channels. **SPEED** sets the modulation speed, **MIX** adjusts the balance of dry and wet signals. You can further sculpt the sound by trimming some of the low- and high-end of the affected signal with the **LO CUT** and **HI CUT** push encoders. Additionally the **PHASE** push encoder can tweak the phase offset of the LFO between left and right channels, and the **SPREAD** push encoder adjusts how much of the left channel is mixed into the right, and vice versa. Finally the **WAVE** push encoder blends between the 'Danish' style digital triangular chorus sound and the classic analogue sine wave.

## Stereo Flanger



The Flanger emulates the phase-shifting sound (comb-filtering) originally created by applying pressure against the flange of the reel on a tape recorder. This effect creates a unique 'wobbly' sound that is quite dramatic when used on vocals and instruments.

The controls of this effect are nearly identical to the controls on the Chorus effect block. Additionally, the **FEEDBACK** can be adjusted with positive and negative amounts, and also band-limited with the **FEED HC** (high-cut) and **FEED LC** (low cut) push encoders.

## Stereo Phaser



A Stereo Phaser, or phase shaper, applies multiple **STAGES** of modulated filters to the input signal to create a 'notch' in the frequency response, and then applies a **MIX** with the original for a 'swirling' effect. Use the M32's Stereo Phaser to add a 'spaced-out' sound to vocal or instrumental tracks.

**SPEED** sets the LFO rate and **DEPTH** sets the LFO modulation depth. The **BASE** push encoder adjusts the frequency range of the modulation filters. The resonance is adjusted with the **RESO** push encoder. **STAGES** determines the number of times the audio signal is processed by the effect. **MIX** determines how much of the affected signal is present in the output audio.

The **WAVE** push encoder shapes the symmetry of the LFO waveform, and **PHASE** dials in an LFO phase difference between the left and right channels.

The modulation source can also be the signal envelope, which produces vowel-like opening and closing tones. The **ENV MOD** push encoder adjusts how much of this effect takes place (positive and negative modulation is possible), and the **ATTACK**, **HOLD** and **RELEASE** push encoders all tailor the response of this feature.

## Dimension-C



Chorus samples the input, slightly detunes it and mixes it with the original signal to produce a somewhat thicker, shimmering sound. Use it to thicken up background vocals, or to double the sound of brass and woodwind instruments. *Inspired by the Roland Dimension D.*

Turning the first push encoder to toggle the output signal between **Mono** and **STEREO**. Pressing the first encoder turns the effect on or off. Pressing the second encoder turns dry mode on or off. Pressing the third, fourth or fifth push encoders engages the chorus effect with increasing intensity.

## Mood Filter



The Mood Filter uses an LFO generator and an auto-envelope generator to control a VCF (voltage-control filter), as well as a side-chain function, where the channel B signal controls the envelope of channel A. When applied to electronic instruments, the Mood Filter can be used to emulate the natural sound of acoustic instruments. *Inspired by the MiniMoog.*

This filter can be modulated with the signal's envelope using the **ENV MOD** (with positive and negative amounts), **ATTACK** and **RELEASE** push encoders, or the LFO can modulate the filter. The **WAVE** push encoder selects between seven different waveforms - triangular, sine, saw plus, saw minus, ramp, square and random. The **PHASE** can be offset by up to 180°. The **SPEED** push encoder adjusts the rate of the LFO, and **DEPTH** adjusts the amount of LFO modulation. Adjust the resonance of the filter until self-oscillation with the **RESO**(nance) push encoder. **BASE** adjusts the range of the filter from 20 Hz to 15 kHz. The **MODE** switch selects between low-pass (LP), high-pass (HP), band-pass (BP) and Notch. Use the **MIX** push encoder to blend the affected signal with the dry sound. With the **4 POLE** switch engaged there will be a steeper slope than the **2 POLE** setting. The **DRIVE** push encoder adjusts the level, and can also introduce an overdrive effect (as with real analogue filters) if pushed hard. In Side-chain mode, only the left input signal is processed and fed to both outputs. The envelope of the right input signal can be used as a modulation source. Applying the **SIDE CHAIN** function ensures that the parameters of the effect are changed based on an external stimulus signal.

## Rotary Speaker



Rotary Speaker emulates the sound of a Leslie rotating speaker. The M32's Rotary Speaker provides more flexibility than its electro-mechanical counterpart, and can be used with a variety of instruments, and even vocals, to create a whirling, psychedelic effect.

The **LO SPEED** and **HI SPEED** push encoders adjust the rotation speed of the Slow and Fast speed selection, and can be toggled with the **FAST** button. The **ACCEL**(eration) push encoder adjust how quickly the speed increases and decreases from the Slow mode to the Fast mode. The rotation effect can also be disengaged with the **STOP** button, which will stop the movement of the speakers.

**DISTANCE** adjust the perceived distance between the speakers and the virtual microphone. **BALANCE** sweeps between low and high frequencies in the output signal. **MIX** determines how much of the affected signal is present in the output audio.

## Tremolo / Panner



Stereo Tremolo creates an up and down volume change at a constant and even tempo just like the guitar amps of yesteryear. Use the M32's Stereo Tremolo to add a unique 'surf-music' texture to a vocal or instrumental track.

**SPEED** adjusts the LFO rate, and **DEPTH** sets the amount of modulation. **PHASE** can be used to set an LFO phase difference between the left and right channels, which can be used for panning effects. The **WAVE** push encoder blends the LFO waveform between triangular and square shapes. The signal envelope, shaped by **ATTACK**, **HOLD** and **RELEASE**, can be used to modulate the LFO speed (**ENV SPD**) and the LFO modulation depth (**ENV DPTH**).

## Suboctaver



The Octave Effect combines the input signal with a digitally synthesised sound one or two octaves below the original signal. This can be used to thicken up guitar sounds, or to add extra 'punch' to kick drums.

The controls for the Suboctaver are split between two discreet layers. Pressing the first push encoder toggles the effect for each layer on or off. The second encoder increases the amount of the affected signal that is present in the output mix. The third encoder switches the range of the signal between **LO**, **MID** and **HI**. The fourth and fifth encoders adjust the level for each of the individual lower octaves. To navigate between the two layers, use the up and down navigational controls.

## Delay + Chamber



Here we have combined Delay and Chamber reverb, so that a single device can supply a variety of delay settings, plus add just the right amount of reverb to the selected signal. This device only uses one effects slot. *Inspired by the Lexicon PCM 70.*

Use the **BALANCE** push encoder to adjust the ration between delay and reverb. Low frequencies can be excluded with the **LO CUT** push encoder, and **MIX** adjust how much of the effect is added to the output signal. The **TIME** push encoder adjusts the delay time for the left channel delay, and **PATTERN** sets the delay ratio for the right channel delay. Adjust the **FEEDBACK** and trim some high frequencies with the **FEED HC** (high-cut) push encoder. The **XFEED** push encoder allows you to send the delay sound to the reverb effect, so instead of running completely parallel, the reverb affects the echoes to a selected degree. The **PREDELAY** push encoder determines the delay before the reverb affects the signal. The **DECAY** push encoder adjusts how quickly the reverb fades. **SIZE** controls how large or small the simulated space (room, cathedral, etc.). The **DAMPING** push encoder determines the decay of high frequencies within the reverb tail.

## Chorus + Chamber



Taking up only one FX slot, the Chorus + Chamber effect combines the shimmer and doubling characteristics of a studio-grade chorus with the sweet sound of a traditional chamber reverb. *Inspired by the Lexicon PCM 70.*

The **BALANCE** push encoder adjusts the balance between chorus and reverb. Low frequencies can be excluded with the **LO CUT** push encoder, and the **MIX** push encoder adjusts how much of the effect is added to the signal. **SPEED**, **DELAY** and **DEPTH** adjust the rate, delay and modulation depth of the chorus. The LFO **PHASE** between the left and right channels can be offset by up to 180°, and **WAVE** adjusts the LFO waveform from a sine wave to a triangular wave. The **PREDELAY** push encoder determines the delay before the reverb affects the signal. The **DECAY** push encoder adjusts how quickly the reverb fades. **SIZE** controls the size of the simulated space (room, cathedral, etc.). The **DAMPING** push encoder determines the decay of high frequencies within the reverb tail.

## Flanger + Chamber



Add the mind-bending, filter-sweeping effect of a state-of-the-art flanger to the elegant sweetening of a traditional chamber reverb - all in one FX slot. *Inspired by the Lexicon PCM 70.*

The **BALANCE** push encoder adjusts the balance between flanger and reverb. Low frequencies can be excluded with the **LO CUT** push encoder, and the **MIX** push encoder adjusts how much of the effect is added to the signal. **SPEED**, **DELAY** and **DEPTH** adjust the rate, delay and modulation depth of the flanger. **FEEDBACK** can be adjusted by positive and negative amounts. The LFO **PHASE** between the left and right channels can be offset by up to 180°. The **PREDELAY** push encoder determines the delay before the reverb affects the signal. The **DECAY** push encoder adjusts how quickly the reverb fades. **SIZE** controls the size of the simulated space (room, cathedral, etc.). The **DAMPING** push encoder determines the decay of high frequencies within the reverb tail.

## Delay + Chorus



This combination effect merges a user-definable delay (echo) with a studio-quality chorus, sure to fatten up even the skinniest track. Uses only one FX slot. *Inspired by the TC Electronic D-Two.*

The **TIME** push encoder adjusts the delay time, and the **PATTERN** push encoder sets the delay ratio for the right channel and negative values activate a cross feedback between the two channels. The **FEEDHC** push encoder adjusts the delay high-cut frequency, while **FEEDBACK** adjusts the number of repeats. The **X-FEED** control allows you to send the delay sound to the chorus effect. The **BALANCE** push encoder adjusts the ratio between delay and chorus. **SPEED**, **DELAY** and **DEPTH** adjust the rate, delay and modulation depth of the chorus. The right channel LFO **PHASE** can be offset by up to 180°, and **WAVE** adjusts the chorus character by shaping the LFO waveform from sine wave to triangular wave. Use the **MIX** push encoder to blend the affected signal with the dry sound.

## Delay + Flanger



This handy dynamic duo blends the 'whoosh' of soaring jet planes with classic delay, and can be adjusted from mild to wild. This combination effect only takes up one FX slot. *Inspired by the TC Electronic D-Two.*

The **TIME** push encoder adjusts the delay time, and the **PATTERN** push encoder sets the delay ratio for the right channel and negative values activate a cross feedback between the two channels. The **FEEDHC** push encoder adjusts the delay high-cut frequency, while **FEEDBACK** adjusts the number of repeats. The **X-FEED** control allows you to send the delay sound to the chorus effect. The **BALANCE** push encoder adjusts the ratio between delay and chorus. **SPEED**, **DELAY** and **DEPTH** adjust the rate, delay and modulation depth of the chorus. The right channel LFO **PHASE** can be offset by up to 180°, and **FEED** (positive and negative amounts) adjusts the feedback effect. Use the **MIX** push encoder to blend the affected signal with the dry sound.

## Modulation Delay



Combining echo and chorus (and in this case, reverb too) is the domain of the Modulation Delay. By combining the two, you can get the best of both worlds in one, dreamy-sounding effect.

The controls are separated onto two layers; layer one for the delay, and layer two for the chorus. Use **Balance** to sweep between how much of either effect is present in the output signal. Navigate to layer two by using the navigational control buttons. Use the **PAR / SER** function to switch between Parallel and Serial modes. In Parallel mode the input signal is routed both to the modulated delay and the reverb inputs. In Serial mode the modulated delay output is routed to the reverb input. (When balance is set to -100 there is no audible difference between the two modes since in this case only the modulated reverb is audible.)

On layer one **Time** adjusts the time of the delay, whereas **Feed** controls how many echoes follow the input signal. **Lo Cut** and **Hi Cut** are, as the names suggest, low cut and high cut filters for the affected signal. On both, **Mix** dictates how much of the affected signal is sent to the output bus.

On layer two **Depth** controls the depth of the chorus effect, **Rate** controls the speed of the modulation, and **Decay** controls the length of time after the initial signal where the effect is present. **Damping** reduces the level of the higher frequencies in the output.

The type of reverb can be switched by pressing either of the third, fourth or fifth push encoders.

## Dual Graphic EQ / Stereo Graphic EQ / Dual TruEQ / Stereo TruEQ

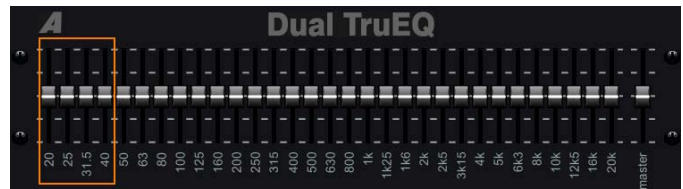
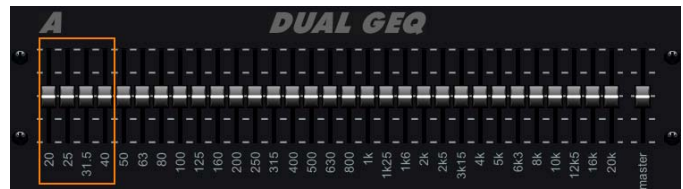

EN

There are four standard graphic EQs that provide 31 bands of adjustment between 20 Hz and 20 kHz. A master volume slider compensates for changes in volume caused by the EQ. A maximum boost or cut of 15 dB is available for each band.

The TruEQ incorporates a special algorithm that compensates for the gain adjustment overlapping effect that adjacent frequency bands have on one another. On a standard EQ, when neighbouring bands are boosted together, the resulting effect is magnified beyond what is visible from the positioning of the sliders.

This compensated EQ will produce an adjustment that is identical to the actual positioning of the sliders.

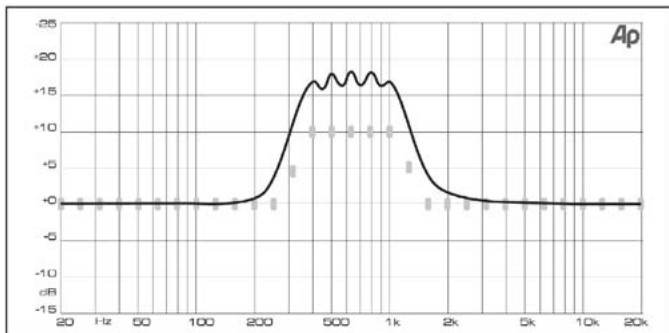

Graphic EQ without frequency response correction.

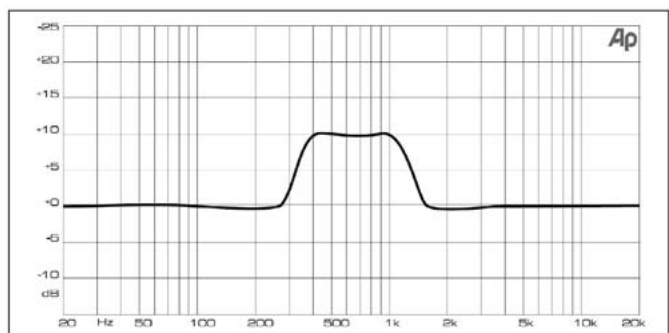

Graphic EQ with frequency response correction.

### Dual DeEsser / Stereo DeEsser



De-essing is an audio effect designed to reduce the amount of excessive sibilance in an audio signal, usually when dealing with the human voice. The Dual DeEsser accurately and seamlessly removes sibilance from audio tracks.

The **Lo-Band** and **Hi-Band** controls select which portion of the audio spectrum is affected by the DeEsser on each channel. By increasing the amount of reduction, the level to which the de-essing affects the input signal can be controlled. By pressing the first and third push encoders, the effect can be targeted specifically at male or female voices.

With the Stereo DeEsser, toggle between Stereo and M/S modes by pressing the fifth push encoder.

### Stereo Xtec EQ1 / Dual Xtec EQ1



Virtually indescribable, recording engineers claim the Pultec EQP-1a to be the “secret sauce” of sound enhancement. We analysed this classic to the core and created an exact physical model that reproduces the multi-faceted sound in painstaking detail. Even the transformers and tube output stage have been faithfully modelled. *Inspired by Pultec EQP-1a.*

**LO FREQ** determines the curve on which the left hand **LO BOOST** and **LO ATT** controls are effective. These controls can be used to either boost or attenuate the signal as required. **HI FREQ**, **HI BOOST** and **HI ATT** perform the same function, but for the higher frequencies. **HI BANDWIDTH** adjusts the width of the high-frequency boost curves.

### Stereo Xtec EQ5 / Dual Xtec EQ5



Pultec simply wrote the book on passive equalisation. By digitally “rebuilding” every aspect of the original Pultec classic, we captured the very essence in our parametric equaliser XTEC EQ5. Our digital re-incarnation is based on the original model and authentically emulates the smooth character of its rather unique components. *Inspired by Pultec MEQ5.*

**LO FREQ**, **MID FREQ** and **HI FREQ** all dictate at which frequencies the **LO BOOST**, **MID CUT** and **HI BOOST** push encoders work.

For all of the Xtec EQs, the **TRANSFORMER** function can be engaged to switch the Transformer emulation on or off, giving a warmer sound. **GAIN** determines how much of the source signal passes through the effect, and **ACTIVE** toggles the EQ in or out of the signal path.



## Wave Designer



Wave Designer is a powerful tool for adjusting signal transients and dynamics such as attack and sustain. Use it to make a snare drum really crack in the mix, or level out volume inconsistencies of slap bass tracks. *Inspired by the SPL Transient Designer.*

Adjusting the **ATTACK** push encoder can add punch or tame overly-dynamic signals. Increasing **SUSTAIN** acts in a similar way to a compressor, allowing the peaks to carry longer before decaying. The effect can also be used to reduce the sustain for a more staccato sound. The **GAIN** push encoder compensates for level changes caused by the effect.

## Precision Limiter

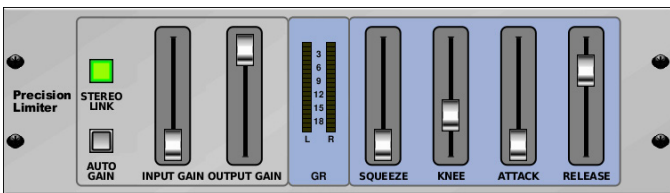

This Stereo Precision Limiter allows you to set a precise volume limit, ensuring distortion-free, optimal signal integrity. Use the M32's Stereo Precision Limiter to boost quiet signals or prevent clipping while preserving the level of 'hot' signals.

**AUTOGAIN** activates an additional long-term gain correction, allowing automatic gain scaling of varying input level ranges. **STEREO LINK** applies limiting to both channels equally when activated. **INPUT GAIN** provides up to 18 dB of gain to the input signal prior to limiting. **OUTPUT GAIN** set the final gain level of the processed signal. **SQUEEZE** adds compression to the signal to add punch and a slight distortion depending on the amount you dial in. **ATTACK** sets the attack time, ranging from 0.05 ms to 1 ms. **RELEASE** adjusts the release time from 0.05 ms to 1.04 seconds. **KNEE** adjusts the soft limiting threshold point from hard limiting (0 dB) to maximum soft limiting (10 dB).

## Stereo Combinator / Dual Combinator



The Combinator is an amazing five-band compressor that emulates famous broadcasting and mastering compressors. A highly complex processor, the Combinator utilises automatic parameter control that produces stunning and "inaudible" results.

Makeup-gain for each frequency band will automatically be adjusted by the Spectral Balance Control (SBC) function, to maintain a balanced audio spectrum.

On the first layer, **Mix** adjusts the overall effect on the input signal (100% equals full compression) and **Active** enables or bypasses the effect. **Attack/Release** adjusts the envelope times for the compressors of all five bands. **Auto** sets program dependent release times (Release time value is ignored). **SBC On** activates 'Spectral Balance Control' which dynamically keeps the gain of all bands in balance (auto Make-up gain adjustment). **SBC Speed** sets the speed of the correction.

**X-Over** adjusts the boundary frequencies of the five frequency bands. Negative values result in more 'resolution' in the lower frequencies and positive values increase resolution in the upper frequencies. The slope or steepness of the band separation filters can be adjusted between 12 dB and 48 dB. **Ratio** sets the compression Ratio for all five bands (1.1 – 10, Limiter). **SBC Meter** switches between SBC gain correction and compressor gain reduction displays.

On layer two, **Threshold** adds a relative offset threshold to all individual band thresholds. This allows adjusting compression amount for all bands simultaneously. **Gain** adjusts overall output gain. **Peak Meter** toggles between compressor peak reduction and band peak-meter displays. **Band Sel** selects one out of the five frequency bands, and **Band Solo** allows listening to the selected band (with the other four bands mute). **Band Thr** and **Band Gain** adjust the threshold and makeup-gain of the selected band. **Band Lock** disables compression for the selected band. Pressing the **Band Reset** encoder will disable **Band Lock** and reset **Band Thr** and **Band Gain** to zero for the selected band. Note that this is not dependant on **Band Solo** and neither is Solo mode affected by **Band Reset**.

## Fair Comp / M/S Fair Comp / Dual Fair Comp



The Fairchild 670 tube compressor not only achieves record bids in high-end vintage gear auctions, it also delivers some of the finest colourations in compressor history. Two small trim VRs preset the control side chain action, a six-step switch determines the timing, and the two large Input and Threshold knobs adjust the levels. Our FAIR COMPRESSOR model is true to the original signal path, and conveniently provides models for dual, stereo-linked or M/S operation. *Inspired by Fairchild 670.*

**INPUT GAIN** determines how much of the input signal passes through the effect. **ACTIVE** toggles the effect in or out of the signal path. **THRESHOLD** determines how loud the signal has to be before compression is applied. **TIME** switches the compression's release time. **BIAS** changes the simulated tube bias algorithm. **OUT GAIN** affects the gain of the output signal.

## Stereo Leisure Comp / Dual Leisure Comp



The immaculate tube signal path in Teletronix's LA-2A Levelling Amplifier has left its exceptional clarity, its rich and warm compression on countless albums of the past decades. The ultra-smooth optical attenuator is closely modelled in our LA COMPRESSOR. It provides breezing, natural and effortlessly musical compression. *Inspired by Teletronix LA-2A.*

**GAIN** determines how much of the input signal passes through the effect. **ACTIVE** toggles the effect in or out of the signal path. **COMP/LIMIT** determines whether the effect acts as a compressor or a limiter. **OUTPUT GAIN** affects the gain of the output signal. Increasing **PEAK REDUCTION** means that only the signal peaks are reduced in level.

## Stereo Ultimo Comp / Dual Ultimo Comp



When Urei released the 1176LN Limiting Amplifier in the late 60s, it broke new ground. Field Effect Transistors employed were just invented and the 1176 was one of the first audio processors to benefit from this new technology. Our digital reincarnation, ULTIMO COMPRESSOR, is based on the early Rev. E model and authentically captures the smooth character of the original class-A output stage and its FET's legendary Fast Attack. *Inspired by Urei 1176LN.*

**INPUT GAIN**, **OUT GAIN**, **ATTACK**, **RELEASE** and **RATIO** all work as per standard compressor functions. With the Dual Compressor, functions for each of the channels are split between Layers 1 and 2.

## Dual Enhancer / Stereo Enhancer



The M32's Enhancers are so called 'Psycho EQs'. They can enhance the signal spectrum in bass, midrange and high frequencies, but they differ from traditional EQs. When you need to generate maximum punch, clarity and detail, without turning up the overall volume, our enhancers are the solution. *Inspired by the SPL Vitalizer.*

Adjust the **BASS**, **MID** and **HI GAIN** push encoders to add or reduce content in those spectrums. The **BASS** and **HI FREQ**(uencies) can be specifically selected, while the **MID Q** (bandwidth) can be adjusted instead. The **OUT GAIN** push encoder compensates for changes in level resulting from the effect, and **SPREAD** (stereo version only) emphasises the stereo content for a wider mix. Engage the **SOLO MODE** to isolate only the audio resulting from the effect so you can hear exactly what you're adding to the mix.

## Dual Exciter / Stereo Exciter



Exciters increase presence and intelligibility in live sound applications, and are indispensable for adding clarity, air and harmonic overtones in the recording studio. This effect is particularly useful for filling out the sound in difficult rooms, and for producing a more natural live or recorded sound. *Inspired by the famous Aphex Aural Exciter.*

Set the frequency of the side-chain filter with the **TUNE** push encoder, and further shape the filter slope with the **PEAK** and **ZERO FILL** controls. Turning the **TIMBRE** push encoder left of centre adds more odd harmonics, while turning it right of centre adds more even harmonics. Adjust the harmonic content added to the signal with the **HARMONICS** push encoder, and blend in the affected signal with the **MIX** push encoder. Engage the **SOLO MODE** to isolate only the audio resulting from the effect so you can hear exactly what you're adding to the mix.

## Stereo Imager



A Stereo Imager is typically used to control the placement of a signal within the stereo field during mixdown or mastering. The M32's Stereo Imager will lend a professional quality to your live and recorded performances.

The **BALANCE** push encoder allows you to emphasise the mono and stereo components of the input signal. The mono and stereo signals can be panned independently with the **MONO PAN** and **STEREO PAN** controls. **OUT GAIN** is used to compensate for level changes resulting from the effect. The phase can also be shifted using the shelving push encoders. Select the frequency and bandwidth (Q) using the corresponding push encoders, then adjust the gain with **SHV GAIN**.

### Edison EX1



The Edison EX1 is an unbelievably powerful psycho-acoustic processor, which allows you to completely manipulate all spatial parameters of the stereo image – such as width and depth – in a way never before possible. You can widen or narrow the stereo spread, bring instruments to the front or move them to the background, and make corrections to the stereo image – even on a finished master. *Inspired by the Behringer Edison EX1.*

**St Spread** increases the perceived width of the audio field over which the signal is present. **Balance** simply adjusts the levels between the left and right channels, and **Center Dist** moves the audio source back and forth in the perceived audio field. **LMF Spread** further adjusts the stereo depth by increasing or decreasing the perceived spaciousness of the output signal.

### Sound Maxer



The SOUND MAXER restores natural brilliance and clarity to any audio signal by adjusting the phase and amplitude integrity to reveal more of the natural texture of the sound, which is often hidden when using some effects and equalisers. *Inspired by Sonic Maximizer 482i.*

Use **LO CONTOUR** to determine the curve on which the **PROCESS** control is effective. **GAIN** determines how much of the input signal passes through the effect. Selecting either of the **ACTIVE** functions activates the effect for either of the two stages.

### Dual Guitar Amp / Stereo Guitar Amp



Modelled after the Tech 21 SansAmp, the Stereo / Dual Guitar Amp simulates the sound of plugging into a real guitar amp. From shimmering cleans to saturated crunch, the M32's Stereo / Dual Guitar Amp allows an electric guitar player to sound great without using an amp on stage.

The **PREAMP** push encoder adjusts the amount of input gain prior to the band-specific distortion adjustment. **BUZZ** adjusts the low-end breakup, **PUNCH** adjusts the midrange distortion, and **CRUNCH** tailors the high-frequency content and distortion for smooth or cutting notes. The **DRIVE** push encoder simulates the amount of power amp distortion from a tube amp. The **LOW** and **HIGH** push encoders allow EQ adjustment independent of distortion content,

and the overall output is controlled by the **LEVEL** push encoder. The **CABINET** simulation can be bypassed if the guitarist is already using a real cabinet, which allows the effect to function like a boost or distortion pedal. The Dual Guitar Amp allows the left and right channels to be adjusted independently.

### Dual Tube Stage / Stereo Tube Stage



Tube Stage / Overdrive is a versatile effect capable of emulating a variety of modern and classic tube amps. Available in stereo and dual-mono versions, use Tube Stage / Overdrive to dial in warm and fuzzy sounds from subtle to fully-saturated.

**DRIVE** adjusts the amount of harmonics being driven by the effect. **EVEN** and **ODD** adjusts the amount of even and odd harmonics. **GAIN** adjusts the output gain of the effect. **LO CUT** sets the input frequency below which the source signal will not pass through the effect. **HI CUT** sets the input frequency above which the signal will not pass through the effect. **BASS GAIN/FREQ** adjusts a low-shelving filter at the output of the effect. **TREBLE GAIN/FREQ** adjusts a high-shelving filter at the effect's output.

### Dual Pitch Shifter / Stereo Pitch



Pitch shifting is often used in two different ways; one is to set the **MIX** control lower and only use the **CENT** control to make a small offset in pitch between the wet and dry tones. This results in a 'voice doubling' effect that thickens the overall sound in a more subtle way. The extreme use of this effect is to turn the **MIX** control fully-clockwise so that the full sound is affected. This way, the signal can be shifted into other keys up to an octave above or below the original key. When used on a voice, it results in a 'chipmunk' sound or a low, 'Darth Vader' effect.

When the **SEMI** and **CENT** push encoders are set to 12:00, the pitch is not altered. Making adjustments by semitone will have a very pronounced effect, whereas changes to the **CENT** control will be very minor. The **DELAY** control creates a time difference between the wet and dry sounds. The **LO CUT** and **HI CUT** push encoders allows the affected signal to be band-limited. The Dual-Pitch effect allows the left and right channels to be adjusted independently, and allows gain compensation and panning of the two channels.

### 3. Rear Panel

#### 3.1 MONITOR / CONTROL ROOM OUT

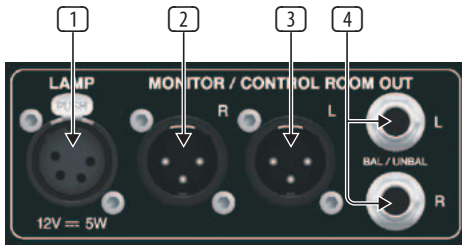

- 1 **External Lamp Socket**  
Connect an external lamp via a standard 12 V / 5 W socket.
- 2/3 **XLR Left & Right Sockets**  
Connect a pair of studio monitors using standard XLR cables.
- 4 **BAL / UNBAL Left & Right Jack Sockets**  
Connect a pair of studio monitors using standard 1/4" cables.

#### 3.2 AC / POWER

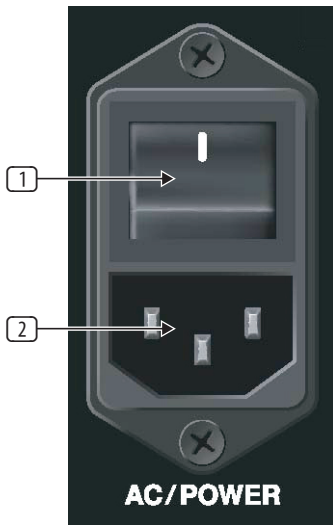

- 1 **Power On / Off**  
Turn the console on and off with the On / Off switch.
- 2 **IEC Power Socket**  
Connect the console to a mains power supply via the standard IEC power socket.

#### 3.3 XLR OUT 1-16

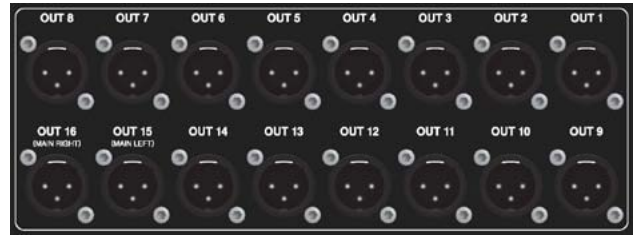

##### Outputs 1-16

Send audio to external equipment using XLR cables. Outputs 15 and 16 by default carry the main stereo bus signals.

#### 3.4 XLR IN 1-32

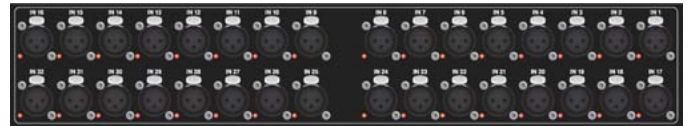

##### Inputs 1-32

Connect audio sources via XLR cables.

#### 3.5 KLARK TEKNIK DN32-USB



##### DN32 USB

Transmit up to 32 channels of audio to and from a computer using the DN32 USB audio interface.

#### 3.6 REMOTE CONTROL

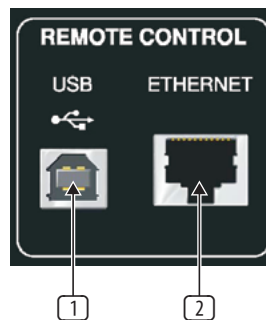

- 1 **USB**  
Connect to a PC for remote control operation via USB.
- 2 **ETHERNET**  
Connect to a PC for remote control operation via Ethernet.

### 3.7 MIDI



#### MIDI IN / OUT

Send and receive MIDI information via standard 5-pin DIN cables.

### 3.9 ULTRANET

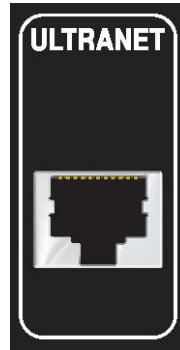

Connect to a personal monitoring system (e.g. the Behringer P16) via Ethernet cable.

### 3.8 AES / EBU OUT

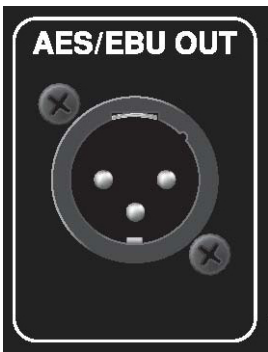

Send digital audio via 3-pin AES/EBU XLR cable.

### 3.10 AES50

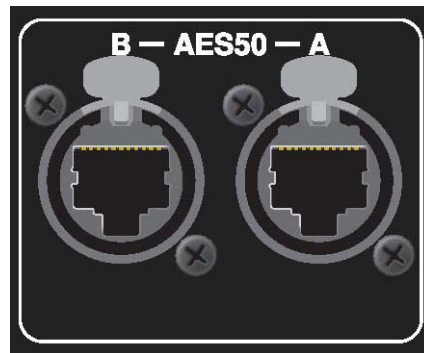

Transmit up to 96 channels in and out via Ethernet cables.

### 3.11 AUX IN / OUT

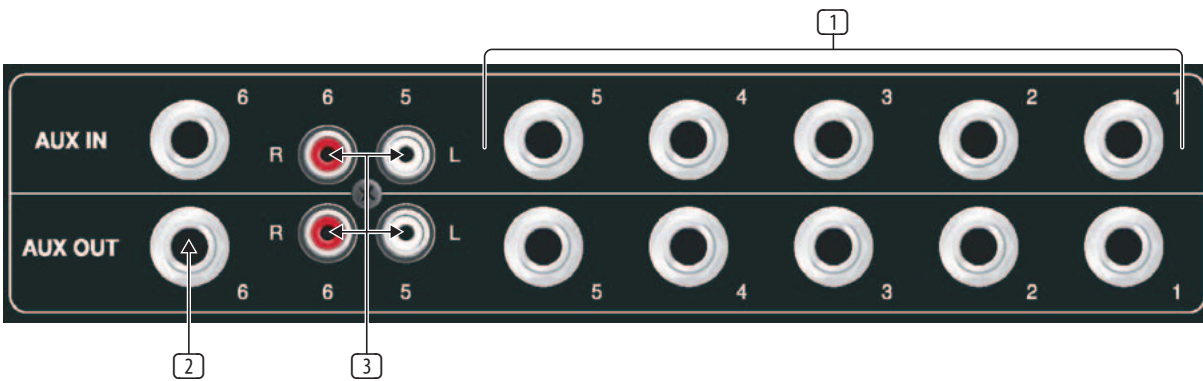

Connect to and from external equipment via 1/4" or RCA cables.

## 4. Appendices

### 4.1 Appendix A: Technical Specifications

Processing	
Input Processing Channels	32 Input Channels, 8 Aux Channels, 8 FX Return Channels
Output Processing Channels	8 / 16
16 aux buses, 6 matrices, main LRC	100
Internal Effects Engines (True Stereo / Mono)	8 / 16
Internal Show Automation (structured Cues / Snippets)	500 / 100
Internal Total Recall Scenes (incl. Preamplifiers and Faders)	100
Signal Processing	40-Bit Floating Point
A/D Conversion (8-channel, 96 kHz ready)	24-Bit, 114 dB Dynamic Range A-weighted*
D/A Conversion (stereo, 96 kHz ready)	24-Bit, 120 dB Dynamic Range A-weighted*
I/O Latency (Console Input to Output)	0.8 ms
Network Latency (Stage Box In > Console > Stage Box Out)	1.1 ms
	<i>* A-weighted figures are typically ~3 dB better</i>

Connectors	
MIDAS PRO Series Microphone Preamplifier (XLR)	32
Talkback Microphone Input (XLR)	1
RCA Inputs / Outputs	2/2
XLR Outputs	16
Monitoring Outputs (XLR / ¼"TRS Balanced)	2/2
Aux Inputs/Outputs (¼"TRS Balanced)	6/6
Phones Output (¼"TRS)	2 (Stereo)
Digital AES/EBU Output (XLR)	1
AES50 Ports (KLARK TEKNIK SuperMAC)	2
Expansion Card Interface	32 Channel Audio Input / Output
ULTRANET P-16 Connector (No Power Supplied)	1
MIDI Inputs / Outputs	1/1
USB Type A (Audio and Data Import / Export)	1
USB Type B, rear panel, for remote control	1
Ethernet, RJ45, rear panel, for remote control	1

Mic Input Characteristics	
Design	MIDAS PRO Series
THD+N (0 dB gain, 0 dBu output)	< 0.01% unweighted
THD+N (+40 dB gain, 0 dBu to +20 dBu output)	< 0.03% unweighted
Input Impedance (Unbalanced / Balanced)	10 kΩ / 10 kΩ
Non-Clip Maximum Input Level	+23 dBu
Phantom Power (Switchable per Input)	+48 V
Equivalent Input Noise @ +45dB gain (150 Ω source)	-125 dBu 22 Hz-22 kHz unweighted
CMRR @ Unity Gain (Typical)	> 70 dB
CMRR @ 40 dB Gain (Typical)	> 90 dB

**Input/Output Characteristics**

Frequency Response @ 48 kHz Sample Rate	0 dB to -1 dB 20 Hz – 20 kHz
Dynamic Range, Analogue In to Analogue Out	106 dB 22 Hz - 22 kHz unweighted
A/D Dynamic Range, Preamplifier and Converter (Typical)	109 dB 22 Hz - 22 kHz unweighted
D/A Dynamic Range, Converter and Output (Typical)	109 dB 22 Hz - 22 kHz unweighted
Crosstalk Rejection @ 1 kHz, Adjacent Channels	100 dB
Output level, XLR Connectors (Nominal / Maximum)	+4 dBu / +21 dBu
Output Impedance, XLR Connectors (Unbalanced / Balanced)	50 $\Omega$ / 50 $\Omega$
Input impedance, TRS Connectors (Unbalanced / Balanced)	20 k $\Omega$ / 40 k $\Omega$
Non-Clip Maximum Input Level, TRS Connectors	+21 dBu
Output Level, TRS (Nominal / Maximum)	+4 dBu / +21 dBu
Output Impedance, TRS (Unbalanced / Balanced)	50 $\Omega$ / 50 $\Omega$
Phones Output Impedance / Maximum output Level	40 $\Omega$ / +21 dBu (Stereo)
Residual Noise Level, Out 1-16 XLR Connectors, Unity Gain	-85 dBu 22 Hz-22 kHz unweighted
Residual Noise Level, Out 1-16 XLR Connectors, Muted	-88 dBu 22 Hz-22 kHz unweighted
Residual Noise Level, TRS and Monitor out XLR Connectors	-83 dBu 22 Hz-22 kHz unweighted

**Display**

Main Screen	7" TFT LCD, 800 x 480 Resolution, 262k Colours
Channel LCD Screen	128 x 64 LCD with RGB Colour Backlight
Main Meter	24 Segment (-57 dB to Clip)

**Power**

Switch-Mode Power Supply	Auto-Ranging 100-240 VAC (50/60 Hz) $\pm$ 10%
Power Consumption	120 W

**Physical**

Standard Operating Temperature Range	5°C – 40°C (41°F – 104°F)
Dimensions	891 x 612 x 256 mm (35.1 x 23.9 x 10.1")
Weight	24.5 kg (53.9 lbs)

## 4.2 Appendix B: MIDI Operation

### MIDI RX > Scenes

Whenever Program Change messages in the range 1-100 are received on MIDI CH01, the corresponding scene of the M32 internal show memory will be loaded.

This requires the following preconditions:

#### SETUP / remote

- MIDI In/Out check marks must be set according to the connection on which MIDI input will be accepted (via physical MIDI connectors on M32 or S16, or via DN32-USB card)
- MIDI In/Out check mark must be set for "Enable MIDI Scene Recall".

#### SETUP / global

- When tick mark "Confirm Pop-Ups" / "Scene Load" is active, MIDI scene recalls will only become active after manual confirmation
- If you prefer activating scenes via MIDI Program Changes immediately, un-check the "Confirm Pop-Ups" / "Scene Load" tick mark.

#### SHOW CONTROL VIEW / home

- Valid scenes must be stored in the internal M32 show file. It is not possible to recall empty scenes
- The scope of changes applied by a MIDI scene recall depends on the Scene Safes, Parameter Safes and Channel Safes settings, same as with recalling the scene locally.

### MIDI TX > Scenes

Every scene can be assigned one specific MIDI command/event. Each time the scene is loaded the MIDI command will be sent out once. Possible choices for MIDI commands/events to be found on Scenes View/MIDI page:

- Off > no message will be sent upon scene load
- Program Change > select the MIDI Channel and the Program Number (using knobs 4/5 at the main display)
- Control Change > select the MIDI Channel, Controller number and value (using knobs 4-6 at the main display)
- Note > select the MIDI Channel, Note number and velocity (using knobs 4-6 at the main display).

Will send out a Note On command directly followed by the same Note Off command.

### Permanent MIDI Assignments Overview (Remote Off)

MIDI RX	MIDI Ch	Controller	Value	Comment
Scenes	1	Program Change	1-100	
Snippet	2	Program Change	1-100	
Cue	3-6	Program Change	0-127	Ch3 -> Cue 1-127, Ch4 -> Cue 128-255, etc.
Mute Groups	2	CC80-85	on (127) / off (0), toggle latching	
Faders	1	CC0-79	0-127	Value 95 = 0dB
Mute	2	CC0-79	on (127) / off (0), toggle latching	
Pan	2	CC0-79	0-127	Value 64 = Pan Mid

MIDI TX	MIDI Ch	Controller	Value	Comment
Mute Groups	2	CC80-85	on (127) / off (0), toggle latching	
Faders	1	CC80-79	0-127	Value 95 = 0dB
Mute	2	CC80-79	on (127) / off (0), toggle latching	
Pan	3	CC80-79	0-127	Value 64 = Pan Mid

### MIDI RX > Assign

Whenever assignable controls are set up for transmitting MIDI commands, reception of that same command (status or continuous) will be reflected on the respective assignable control element (button light, encoder LED collar).

### MIDI TX > Assign

The assignable MIDI commands have been restricted to some generic elements: Encoders 1-4 > can be assigned to sending control changes, program changes or notes.

- Parameters are currently 'Channel' and 'Value'
- For CC and Note commands 'Value' = controller number/note number, and the encoder rotation determines the controller value/note-on velocity

- For Program Changes only the channel is specified, and the encoder rotation determines the program number

Buttons 5-12 > can be operated in two modes, 'MIDI Push' (non-latching) for momentary commands, or 'MIDI Toggle' (latching) for static commands.

### MIDI Push

Can be assigned to sending control changes, program changes or notes

Parameters are currently 'Channel' and 'Value'

For CC and Note commands 'Value' 0..127 = controller number/note number, and the button momentarily toggles the controller value/note-on velocity

To 127 (depressed/released]



For Program Changes 'Value' 0...127 = program/preset number, that will be sent upon pressing the button.

### MIDI Toggle

Can be assigned to sending control changes or notes

Parameters are currently 'Channel' and 'Value'

For CC and Note commands 'Value' 0...127 = controller number/note number, and the button toggles the controller value/note-on velocity

Between value/velocity 127 and 0 with every operation.

### PLEASE NOTE:

The ASSIGN section also reflects/displays reception of the same MIDI commands that are selected for transmission

The MIDI commands assigned to the ASSIGN controls can be transferred to and from stage via AES50 using the S16 stage box MIDI I/O.

### MIDI RX/TX > Remote

Enables a specific form of bi-directional MIDI communication for remote controlling a computer DAW application using control elements of the M32 console. REMOTE can be used in three modes, Mackie Control, HUI and raw MIDI CC (raw) controllers (see *SETUP/remote*)

MIDI CC (raw) selected and Remote is enabled+active, the group section controls will transmit/receive the following messages:

HUI selected and Remote is enabled+active, then the group fader section and buttons will emulate the HUI control surface protocol, i.e. for ProTools.

SELECT/SOLO 1-8 buttons will select or solo the corresponding track in the DAW, in banks of eight tracks

MIDI RX	MIDI Ch	Controller	Comment
Group 1-8 SELECT	1	Note 64-71	on (127) / off (0), push non-latching
Group 1-8 SOLO	1	CC 32-39	on (127) / off (0), toggle latching
Group 1-8 MUTE	1	CC 40-47	on (127) / off (0), toggle latching
Sends On Fader	1	CC 48	on (127) / off (0), toggle latching
Group DCA 1-8	1	Note 72	on (127) / off (0), push non-latching
BUS 1-8	1	Note 73	on (127) / off (0), push non-latching
BUS 9-16	1	Note 74	on (127) / off (0), push non-latching
MTX 1-6	1	Note 75	on (127) / off (0), push non-latching
GROUP Faders	1	CC0-7	0-127

Sends On Fader = enables touch-writing a fader automation on selected track, track automation mode in DAW must be 'touch', (latching)

Use the layer buttons to determine the function assigned to the MUTE 1-8 buttons, the LED displays indicate that function.

- Group DCA 1-8 = allows movement of the bank selection of tracks in a DAW, (push non-latching)
- BUS 1-8 = allows the setting of DAW tracks to 'Record Ready', (push non-latching)
- BUS 9-16 = enables use of MUTE buttons for track mute in the DAW, (latching)
- MTX 1-6 = enables use of MUTE buttons for transport controls in the DAW, (latching).

MACKIE CTRL selected and Remote is enabled+active, then the group fader section and buttons will emulate the Mackie Control Universal protocol

SELECT/SOLO 1-8 buttons will select or solo the corresponding track in the DAW, in banks of eight tracks

Sends On Fader = enables touch-writing a fader automation on selected track, track automation mode in DAW must be 'touch' or 'latch', (latching)

Use the layer buttons to determine the function assigned to the MUTE 1-8 buttons, the LED displays indicate that function.

- Group DCA 1-8 = allows movement of the bank selection of tracks in a DAW, (push non-latching)
- BUS 1-8 = allows the setting of DAW tracks to 'Record Ready', (push non-latching)
- BUS 9-16 = enables use of the MUTE buttons for track mute in the DAW, (latching)
- MTX 1-6 = enables use of the MUTE buttons for transport controls in the DAW, (latching).

### 4.3 Appendix C: Dimensions

Front View

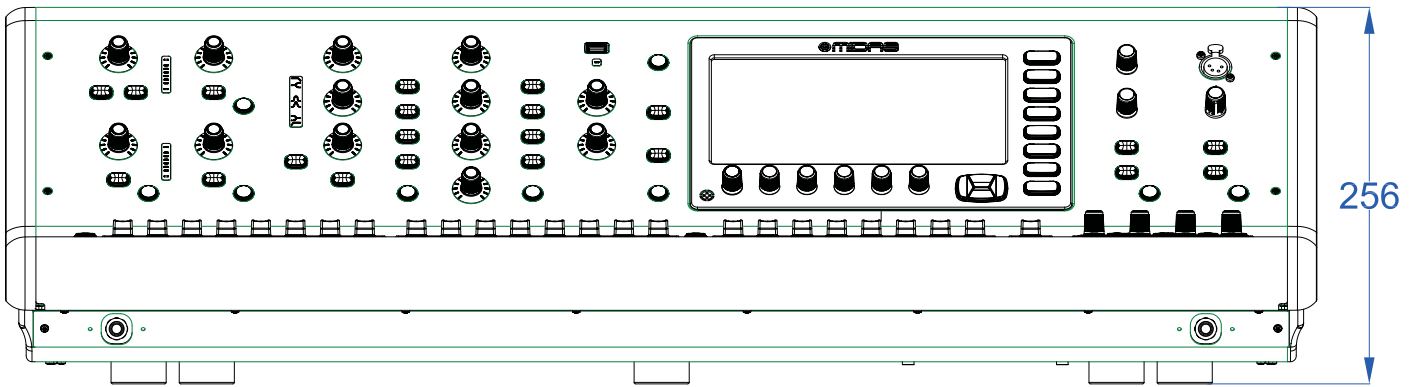

Top View

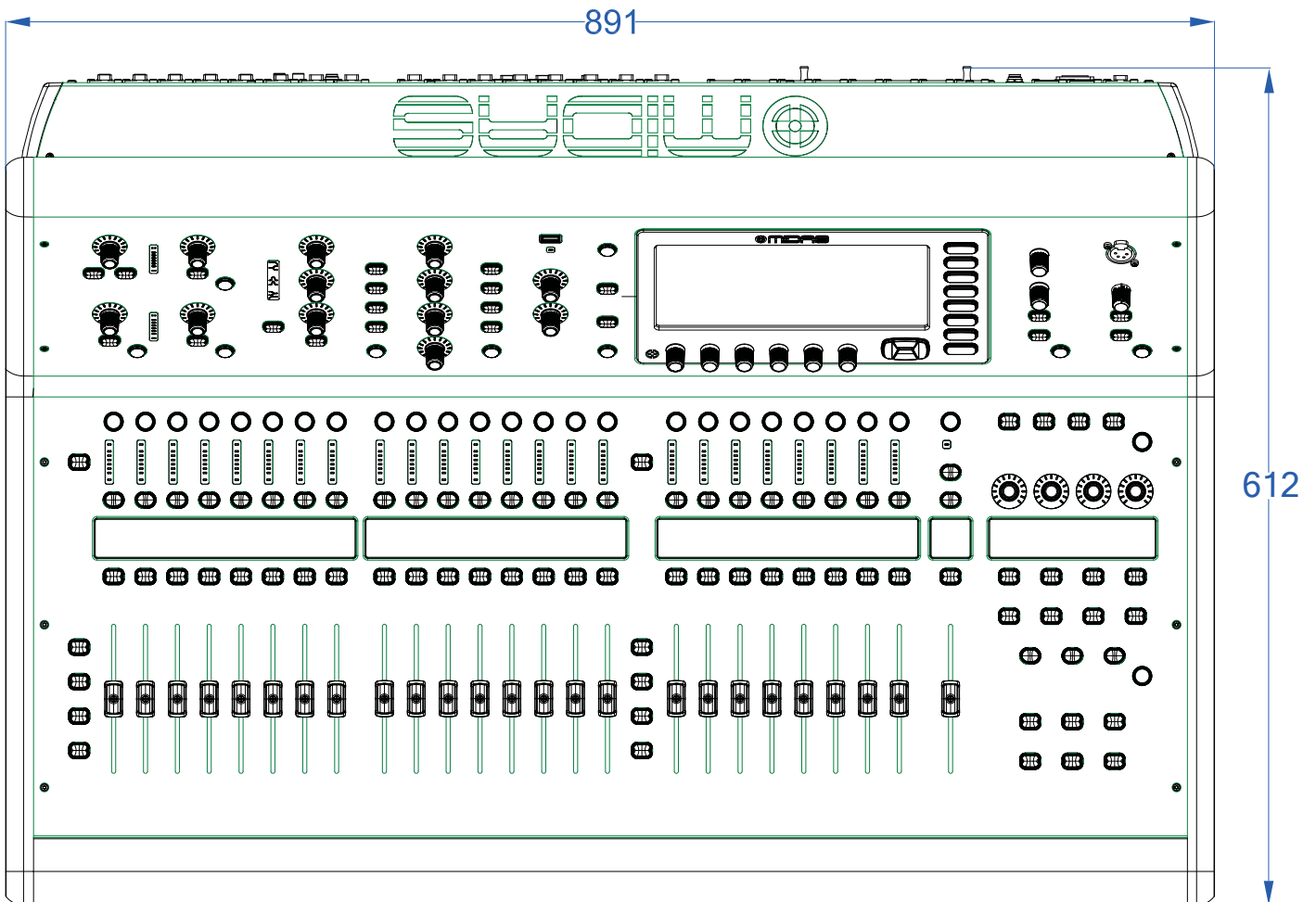

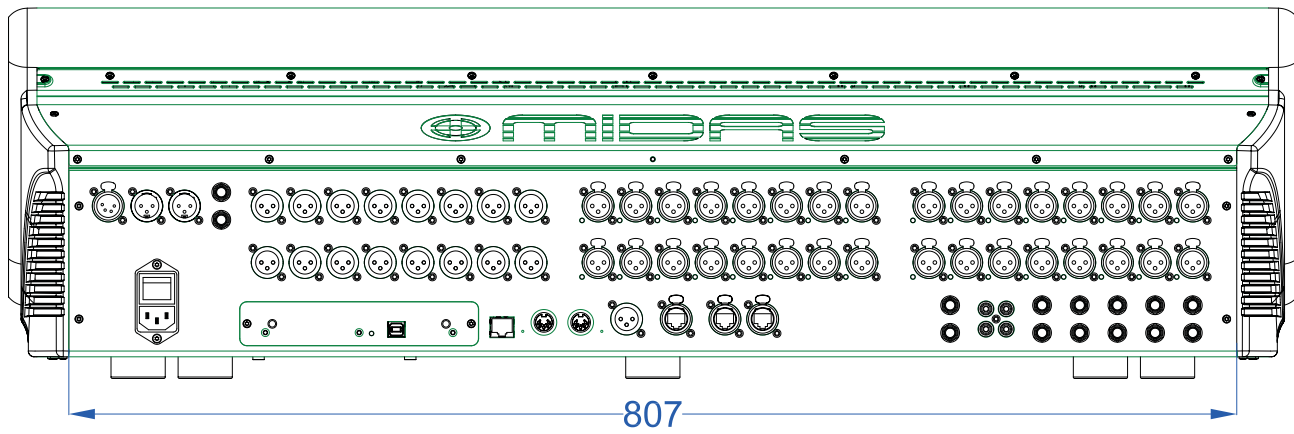
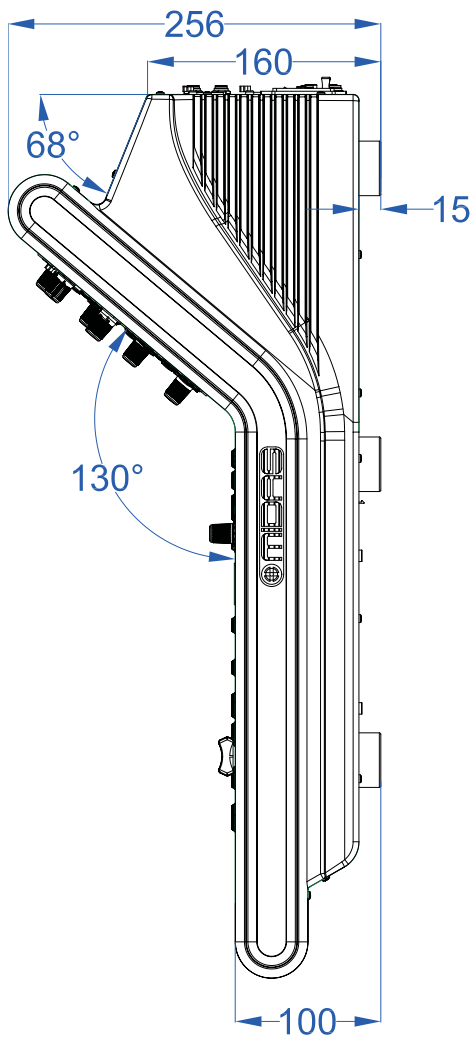
**Rear View****Side View**

4.4 Appendix D: Block Diagram

Midas M32 Block Diagram

Revision 1.2014-06-27\_ID

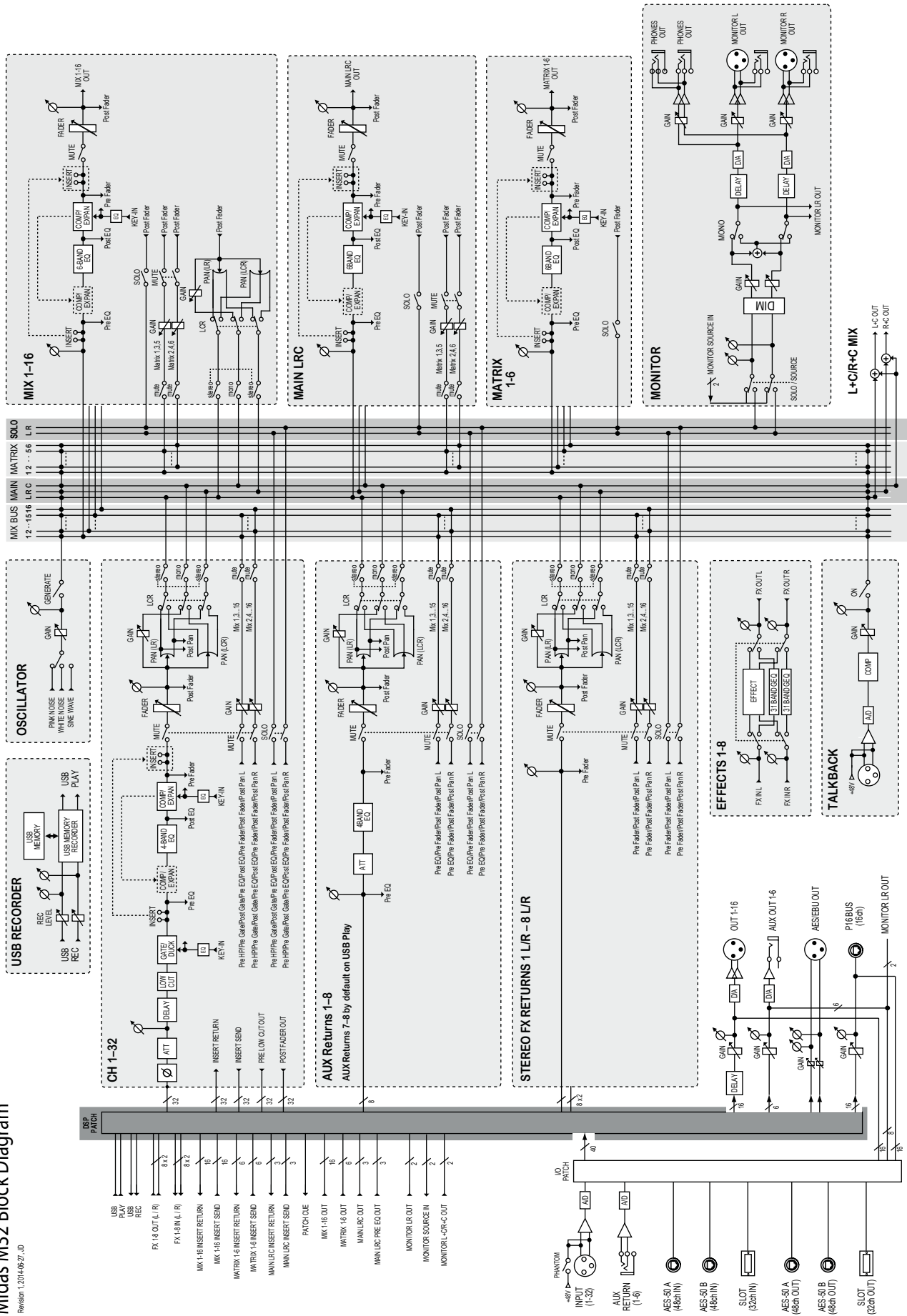

## 4.5 Appendix E: Service Information

This appendix contains routine service information for the M32 Digital Console.

### Routine Maintenance

To help keep your M32 Digital Console unit in good working order and to make sure it gives you optimum performance, we recommend that you carry out the following about once every month.

- Clean the control centre, as detailed in 'Cleaning the control centre' (below)
- Check controls for freedom of operation. As the controls are 'self-cleaning', this operation will help to prevent them from sticking
- Check the functionality of all controls, that is, control knobs, faders, pushbuttons, LEDs, etc.
- Check the functionality of equipment.

### Cleaning The Control Centre

Switch off the control centre and electrically isolate it from the mains before cleaning.

Clean the control centre using a dry, lint-free cloth. Do not use harsh abrasives or solvents. When cleaning the equipment, take great care not to damage faders, pushbuttons etc.

### Cleaning a GUI Screen

Switch off the control centre and electrically isolate it from the mains before cleaning.

Carefully wipe the surface of the GUI screen with a soft, lint-free cloth or screen wipe specially designed for the purpose. When cleaning the GUI screen, observe the following precautions:

- Avoid putting pressure on the screen
- Don't use harsh abrasives, for example, paper towels
- Don't apply liquids directly to the screen
- Don't use ammonia-based cleaners and solvents, such as acetone.

If you are in doubt or have any queries about cleaning the GUI screens, contact MIDAS Technical Support.

### Equipment Disposal

When this equipment has come to the end of its useful life, its disposal may come under the DIRECTIVE 2012/19/EU OF THE EUROPEAN PARLIAMENT AND OF THE COUNCIL of 27 January 2003 on waste electrical and electronic equipment (WEEE).



Hazardous substances in WEEE contaminate water, soil and air and ultimately put at risk our environment and health. The directive aims to minimize the impacts of WEEE on the environment during their lifetimes and when they become waste.

The WEEE directive addresses the disposal of products when they have reached the end of their life and contributes to the reduction of wasteful consumption of natural resources. This will help to reduce pollution, and protect the environment and ourselves.

If this equipment carries a 'crossed-out wheeled bin' (shown left), please do not dispose of WEEE as unsorted municipal waste but collect and dispose of in accordance with local WEEE legislation. The horizontal bar underneath indicates that the product was placed on the EU market after 13th August 2005.

For WEEE disposal see our website at [midasconsoles.com](http://midasconsoles.com) for information.

## 4.6 Appendix F: Glossary

This glossary provides an explanation of the symbols, terms and abbreviations used in this manual.

**5.1 surround:** A surround sound system created from six channels that form a discrete signal, which is played back over a speaker system comprising five speakers (three front and two rear) and a subwoofer (which is the '.1' or LFE channel). See LFE.

**μ:** Micro- prefix symbol that represents 10<sup>-6</sup> or one millionth.

### A

**A/D:** Abbreviation for 'analogue to digital'. The conversion of a continuous signal into a numeric discrete sample sequence.

**AC:** Abbreviation for 'alternating current'.

**AES/EBU:** Abbreviation for 'Audio Engineering Society/European Broadcasting Union'. See AES3.

**Acoustic feedback:** A sound loop existing between an audio input and audio output that is amplified on each cycle. For example, a mic input signal is amplified and passed to a loudspeaker. The output from the loudspeaker is picked up the mic, which amplifies it again and passes it back to the loudspeaker, and so on.

**AES3:** Also known as 'AES/EBU', this is a serial interface for transferring digital audio between devices.

**AES50:** AES digital audio engineering standard. AES50 is a high resolution, multi-channel audio interconnection (HRMAI). Rather than a network, it is a high-performance, point-to-point audio interconnection, although the auxiliary data may operate as a true network, independently of the audio. HRMAI provides a professional multi-channel audio interconnection that uses Cat 5e data cable and is compatible with Ethernet networks.

**AFL:** Abbreviation for 'after fader listen'. A function that allows the signal to be monitored post-fader, that is, after it has been acted upon by the fader.

**Algorithm:** In computing, a set of instructions for accomplishing a specific task.

**amp (A):** Abbreviation for 'ampere'. A unit of current.

**Anti-aliasing:** When referring to digital images, a technique that avoids poor pixelation.

**Area A:** Primary input control area.

**Area B:** A secondary input control area.

**Assignable controls:** User-assignable controls that can be set up to operate other functions.

**Auto safe:** Prevents channel from accepting scene recall.

**Auto-mute:** A function that automatically mutes the channel's signal under certain conditions.

**Auto-mute group:** A function that automatically mutes a number of selected channels under certain conditions.

**Automation:** 1. Memorization and playback of changes made to mixer settings. 2. An area on the master bay that controls these.

**Aux:** Abbreviation for 'auxiliary send' or 'aux send'. A designation for extra buses, typically used for sending signal to effects, headphone amps and other destinations. See Bus.

**Aux send:** See Aux.

### B

**Balanced audio:** A type of audio connection that uses the three leads in a cable, connector and jack as part of a phase-cancelling arrangement to boost the signal and reduce noise.

**Band:** In EQ, a range of frequencies.

**Bandwidth:** In EQ, the width of a band, that is, the number of frequencies that will be boosted/cut above and below a centre frequency.

**Bank:** A fixed number of channels displayed on a GUI screen.

**Bass:** Lower frequencies in a signal.

**Bay:** One of the main control surface sections.

**Bus:** A pathway down which one or more signals can travel.

### C

**Cat 5e:** A specification for a type of cable used typically for Ethernet computer networks.

**Channel:** Single path taken by an audio signal (input or output) through the control centre.

**Channel strip:** Row of controls in traditional analogue layout used for the shaping of a signal.

**Checkpoint:** A patching data store point, created by clicking CHECKPOINT. See Patching.

**Click:** A method of GUI operation, mainly for button operation and selection purposes.

**CMR:** Abbreviation for 'common mode rejection'. A measure of how well a differential amplifier rejects a signal that appears simultaneously and in-phase at both input terminals. CMR is usually stated as a dB ratio at a given frequency.

**Comb filtering:** Removal of signal components at a number of regularly spaced frequencies.

**Compressor:** A dynamics processor that reduces the level of any signal exceeding a specified threshold volume.

**Condenser microphone:** A high quality mic that uses a capacitor to detect changes in the ambient air pressure, which it then converts into an electrical signal. This type of mic requires power from a battery or external source.

**Control centre:** The M32's console, comprising control surface and GUI.

**Control surface:** Area on the control centre that houses all of the user's hardware controls, such as pushbuttons, control knobs, switches etc.

**Crossfade:** To combine signals such that one channel or source fades out while another fades in, but maintaining an essentially constant programme volume.

**Cursor:** Generally, used to describe the 'I'-shaped pointer on the GUI that indicates a text insertion point. See Pointer.

### D

**D zone:** Section in the input channel strip for controlling dynamic parameters.

**D/A:** Abbreviation for 'digital to analogue'. The conversion of digital data to analogue audio.

**DARS:** Abbreviation for 'digital audio reference signal'.

**Dashboard:** A standard GUI screen display - usually on the master bay - that shows all channel meters (inputs, auxes, returns, masters etc.) all of the time.

**DAW:** Abbreviation for 'Digital Audio Workstation'. A digital audio workstation is an electronic system designed solely or primarily for recording, editing and playing back digital audio.

**dB:** Symbol for 'decibel'. A unit of measurement of the loudness of sound. See dBu.

**dBu:** A unit of measurement of sound used in professional audio. Derived from the decibel, where the 'u' stands for unloaded, this unit is an RMS measurement of voltage based on 0.775 VRMS, which is the voltage at which you get 1 mV of power in a 600 ohm resistor. This used to be the standard impedance in most professional audio circuits.

**DC:** Abbreviation for 'direct current'.

**Delay:** An effect by which a reproduction of a signal is played back later than its original.

**Destination:** The patch connector to which a signal is routed. See Patching.

**Device:** A diagram(s) in the I/O tabs representing a physical rack unit, such as a line I/O, mic splitter, DN9696, AES50 etc. See Patching.

**DI:** Abbreviation for 'direct inject' or 'direct injection'. Signal is plugged directly into the audio chain without using a microphone.

**DI box:** Device for matching signal level impedance of a source to mixer input.

**Drag:** A method of GUI operation, mainly for control adjustment. Also used for selecting blocks of patch connectors during patching.

**DSP:** Abbreviation for 'digital signal processing' or 'digital signal processor'. Any signal processing done after an analogue audio signal has been converted into digital audio. Can be used to create, for example, compression, equalisation etc., of a digital signal. A digital signal processor is a piece of equipment specifically designed for carrying out signal processing.

## E

**E zone:** Section in the input channel strip for controlling EQ parameters.

**Effect:** One of a number of audio processes that can be applied to a signal to modify it, such as reverb, flanging, phasing, delay etc.

**Effects rack:** A virtual rack of internal processors. See Virtual rack.

**Envelope:** 1. How a sound or audio signal varies in intensity over time.  
2. The visual representation of such, usually shown on a graph in a GUI channel strip.

**EQ:** Abbreviation for 'equaliser' or 'equalisation'.

**Equalisation:** Adjusting the frequency response so that the levels of all frequencies are equal or the same. Bass and treble controls are equalisation controls.

**EtherCon®:** A cable connector for data transfer interconnections, which is more robust than the basic RJ45.

## F

**Fader:** Slider-type device for precise adjustment of signal level or volume of a channel.

**Fast strip:** One of the strips in the input, mix and output fast zones. See Input fast strip, Mix fast strip, Output fast strip and Fast zone.

**Fast zone:** An area on a bay that contains quick controls. See Input fast zone, Mix fast zone, Output fast zone and Fast strip.

**FB:** Abbreviation for 'front-back'. A term used in surround panning.

**Feedback:** See Acoustic feedback.

**Filter:** A device for removing frequencies above or below certain levels.

**FOH:** Abbreviation for 'front of house'. The area in a theatre used by the public. Used to describe a control centre being used to control the sound that the audience will hear (and not the performers' monitor system).

**Frequency:** The number of times that a sound wave's cycle repeats within one second.

**Fricative:** A consonant, such as 'f' or 's', produced by the forcing of breath through a constricted passage.

**From section:** The leftmost area of the patching screen that contains the source patch connectors. See Patching.

## G

**Gain:** Another term for signal level.

**Gain reduction (compressor):** Decrease in gain when input signal is above threshold. See Gain.

**GEQ:** Abbreviation for 'graphic equaliser'. See Graphic EQ.

**GEQ rack:** A virtual rack of GEQs. See Virtual rack.

**Granularity:** A measure of the size of components or a description of the components comprising a system.

**Graphic EQ:** A form of EQ that has a number of faders for controlling the gain of the audio signal. The faders are set at frequency bands that are evenly-spaced according to octaves.

**GUI:** Abbreviation for 'graphical user interface'.

**GUI channel strip:** Right section of a GUI screen that represents the processing area of the input or output channel strip selected to the control surface.

**GUI menu:** A menu selectable at either GUI screen by clicking the home button (upper-left corner).

**GUI screen:** One of the M32's two screens, which comprise the GUI.

## H

**HPF:** Abbreviation for 'high pass filter'. A filter that removes lower frequencies from a signal, leaving the higher frequencies unaffected.

**Hum:** Undesirable low frequency tone present in a signal due to grounding problems or proximity to a power source.

**Hz:** Symbol for 'Hertz'. A unit of frequency equal to one cycle of a sound wave per second.

## I

**I zone:** Area on the master bay that contains the operator-assignable effects controls.

**I/O:** Abbreviation for 'input/output'.

**ID:** Abbreviation for 'identification'.

**Ident:** Scale marking, or gradation, around a control knob to help indicate the current setting and to assist in accurate adjustment.

**Impedance (Z):** Opposition to the flow of alternating current in a circuit, measured in ohms.

## K

**Kernel:** For computers, the kernel is the central component of most operating systems.

## L

**LCD select button:** LCD button in the input fast strips and VCA groups, used for channel/group navigation and selection, and operator feedback.

**LFE:** Abbreviation for 'low frequency effects'. Typically, the '.1' in '5.1 surround' is an LFE channel.

**LFO:** 1. Abbreviation for Low-Frequency Oscillation, an electronic signal which is usually below 20 Hz and creates a rhythmic pulse or sweep. This pulse or sweep is often used to modulate synthesizers, delay lines and other audio equipment in order to create effects used in the production of electronic music. 2. Abbreviation for Low-Frequency Oscillator, the device itself which produces low-frequency oscillation.

**Linux:** Also known as 'Linux kernel'. Operating system kernel used by a family of Unix-like operating systems. See kernel.

**LS:** Abbreviation for 'left surround'. The left rear speaker in a 5.1 surround system.

## M

**MADI:** Abbreviation for 'multi-channel audio digital interface'.

**Master bay:** Control area for masters, automation, comms, monitoring etc. Also contains the primary navigation zone.

**Masters:** The three master channels (mono and stereo left and right) in the master bay.

**MB:** Abbreviation for 'megabyte'.

**MC:** Abbreviation for 'master controller'.

**Meter:** Visual device to indicate the level of a signal.

**Meters screen:** One of the GUI screens. This is the default screen of the master bay.

**Mic:** Abbreviation for 'microphone'.

**Microphone:** Device for converting sound waves into audio signals.

**MIDI:** Acronym for 'musical instrument digital interface'. A digital signal system standard that facilitates integration of musical instruments, such as synthesizers and guitars, with computers.

**Mix:** 1. A signal that contains a combination of signals, such as a pair of stereo signals with numerous effects. 2. The act of creating such a combination. 3. A type of bus. See Bus.

**Mix bay:** Control area for outputs and groups.

**Mixer:** 1. A console or other device that blends input signals into composite signals for output. 2. An engineer/technician who carries this out, especially during a live performance.

**mm:** Symbol for 'millimetre' (one thousandth of a metre).

**MON:** Abbreviation for 'monitor', used to describe a control centre being used to mix the signals sent to the stage monitor speakers.

**Monitor:** 1. Speaker(s) used for listening to a mix or live audio. 2. The act of listening to a mix or live audio.

**Monitor A:** Primary monitor bus system.

**Monitor B:** Secondary monitor bus system.

**Monitors:** Control area on the master bay for monitoring the A and B signal paths.

**Mono:** A single signal.

**Mute:** Function that allows a channel's signal to be silenced.

**Mute safe:** Function that means a mute cannot be controlled by scene recall or auto-mutes.

## N

**N/A:** Abbreviation for 'not applicable'.

**nm:** Symbol for nanometre (one billionth of a metre).

**Normalise:** To boost the amplitude of a digital sound so that it is as high as it can be without clipping (0 dB).

**Normalisation:** An automatic process whereby the gain of all program material is adjusted so that the peak level will just arrive at 0 dB.

**Normalised connection:** Also known as 'normalised connection'. A connection that allows a signal to pass through it when no plug is inserted in it, but breaks the connection when a plug is inserted.

**Normalising:** The process of making audio files the same volume.

**NVRAM:** Abbreviation for 'Non-volatile random access memory'. This is the general name used to describe any type of RAM that retains its information when power is switched off. For example, flash memory.

## O

**O/B:** Abbreviation for 'outside broadcast'.

**Oct:** Abbreviation for 'octave'.

**Octave:** A difference in pitch where one tone has a frequency that is double or half of the frequency of another tone.

**ohm ( $\Omega$ ):** Unit of electrical resistance.

**OpticalCon<sup>®</sup>:** A cable connector for fibre optic cables.

**OS:** Abbreviation for 'operating system'.

**OSC:** Abbreviation for 'oscillator' or 'oscillation'.

**Out of phase:** 1. A signal, being similar to another in amplitude, frequency and wave shape, but offset in time by part of a cycle. 2. 180° out of phase or having opposite polarity. See Phase.

**Outboard:** External, as in an 'external device'.

**Outboard equipment:** External equipment used with the M32 Control Centre, but that is not part of it.

**Output:** 1. The signal put out by a device. 2. The physical location of where a device sends out a signal.

**Output fast strip:** One of 16 channel strips in the output fast zone. Provides detailed control of the currently selected outputs. See Output fast zone.

**Output fast zone:** Control area for fast access to primary main output functions.

**Overload:** A condition where the signal level is too high.

**Overview:** The main view in the GUI channel strip, which contains the control sections of the selected channel. This represents the associated channel strip on the control surface.

**Overview screen:** One of the GUI screens. This is the default screen of the mix bay.

## P

**PAN:** Abbreviation for 'panoramic'.

**Panning:** The left/right positioning of a signal across a stereo image.

**Parameter:** A setting whose value can be altered by the user.

**Parametric EQ:** A type of EQ that allows all of the parameters of equalisation to be changed, including centre frequency, boost/cut in gain and bandwidth.

**Patch:** A temporary connection (physical or virtual) made between two audio devices or inside one.

**Patch connector:** Any tab patching point, for example, an XLR connector, bus, sidechain compressor etc. See Patching.

**Patching:** Also known as 'soft patching'. The process of routing a channel/signal from a source to a destination(s).

**PCB:** Abbreviation for 'printed circuit board'.

**PEQ:** Abbreviation for 'parametric equaliser'. See Parametric EQ.

**PFL:** Abbreviation for 'pre-fade listen'. A function that allows the signal to be monitored pre-fader, that is, before it reaches the fader.

**Phantom power:** The power required for the operation of a condenser microphone when it is not supplied by internal batteries or a separate power supply. This is supplied by the M32 Control Centre itself.

**Phase:** A measurement (in degrees) of the time difference between two waveforms.

**Pitch:** A continuous frequency over time. Musical interpretation of an audio frequency.

**Pitch shift:** Alteration of pitch or frequency, but without adjusting tempo.

**Point scene:** Subdivision of a scene. See Scene.

**Pointer:** 1. On the GUI, the pointer is the arrow-shaped object on the screen that moves when the user moves the trackball or external mouse. 2. On a control knob, it is the marking that, when used in conjunction with the indent around edge of control knob, helps to indicate the setting.

**POP:** Abbreviation for 'population'.

**POP group:** A number of channels assigned to a group that has unfold and area B controls. Provides an easy and quick method of manipulating and controlling the numerous channels available on the M32 Control Centre.

**Post-:** The point for accessing audio just after it leaves a specific channel component, for example, 'post-fader', where the audio is tapped from just after it leaves the channel's main level control.

**Pre-:** The point for accessing audio just before it reaches a specific module, for example, 'pre-EQ', where the audio is tapped from just before it gets to a channel strip's EQ.

**Primary navigation zone:** Area in the master bay for mix and master bay GUI screen navigation and control. Also has a screen access section for fast access to GUI menu options.

**Processing area:** A display in a GUI channel strip showing a specific control section. Accessed from the channel's overview display. See Overview.

**PSU:** Abbreviation for 'power supply unit'.



**Psychoacoustics:** The study of the perception of sound, that is, how we listen, our psychological responses and the physiological effects on the human nervous system.

**Psychoacoustic noise:** Noise that affects the physiology of the listener.

## Q

**Quick access button:** Button for navigation/ selection of a channel/bus/ processing area.

## R

**RAM:** Abbreviation for 'Random access memory'.

**Return:** Auxiliary return or aux return. An extra input used for receiving a signal from the output of an internal or external effect processor. See Bus.

**Reverb:** An effect where the ambience of a physical space is simulated. This is done by copying a signal and replaying at regular intervals at ever decreasing levels. The intervals are so close that each copy is not heard individually.

**RMS:** Abbreviation for 'root-mean-square'. The square root of the mean of the sum of the squares. Commonly used as the effective value of measuring a sine wave's electrical power. A standard in amplifier measurements. The effective average value of an AC waveform.

**RS:** Abbreviation for 'right surround'. The right-hand rear speaker in a 5.1 surround system.

## S

**s:** Symbol for 'second'. A unit of time.

**Scene:** In automation, a set of mix settings for a particular part of a performance, for example, a play or song.

**Sibilance:** Energy from a voice, centred around 7 kHz, and caused by pronouncing 's', 'sh' or 'ch' sounds.

**Side chain:** A special circuit that diverts a proportion of the main signal so that it can be processed, as required. Compressors use the side chain to derive their control signals.

**Signal flow:** The path of a signal from one place to another.

**SIP™:** Abbreviation for 'solo in place'.

**SIS:** Abbreviation for 'spatial imaging system'. Combines a central loudspeaker cluster with a left-right system to form three discrete sound channels.

**Snapshot:** A captured group of mixer settings that reflect the state of the mixer at a particular moment within a performance. This snapshot can then be recalled at the required moment in the performance/playback.

**Solo:** During monitoring, the isolation of one signal by silencing all other signals.

**Source:** The patch connector from which a signal is patched. See Patching.

**SPL:** Abbreviation for 'sound pressure level'. Given in decibels (dB), SPL is an expression of loudness or volume.

**Splash screens:** The GUI display during power up.

**SRC:** Abbreviation for 'sample rate converter'.

**SSD:** Abbreviation for 'solid-state disk'. Data storage device that uses non-volatile memory to store data. Quicker than the conventional hard disk and less susceptible to the failures associated with hard disk drives.

**Status indicator:** A device specifically designed to show the condition of something. For example, an LED that shows whether a pushbutton is on or off, or a meter showing the level of a signal.

**Stereo:** Two separate channels, left and right, used to give the listener the perception of where the noise is coming from. Usually used with music to give a fuller, more natural sound.

**Stereo image:** The perception of the different sound sources coming from far left, far right or anywhere in between.

**Surround:** Audio that has more than two speaker locations and, therefore, more than two channels. Also commonly termed 'surround sound'.

**Synchronisation (sync):** Coordination of timing between devices.

## T

**Tab:** A 'sheet' in the From and To sections that contains a specific group of patch connectors. See Patching.

**TFT:** Abbreviation for 'thin film transistor'.

**Threshold:** Level at which dynamics processing will begin to operate.

**Tie line:** A dedicated connection between two systems, typically between FOH and MON positions.

**To section:** The rightmost area of the Patching screen that contains the destination patch connectors. See Patching.

**Tooltip:** The information box that appears next to the pointer when it passes over or pauses on items on certain GUI screens, such as the channels on the Overview and Patching screens.

**Touchpad:** Also known as 'trackpad'. An input device on a laptop PC for controlling the on-screen pointer.

**Track:** Single stream of recorded audio data.

**Trackball:** Device, located in the primary navigation zone, for GUI screen navigation and control of the mix and master bays.

**Treble:** Higher frequencies in a signal.

**TW:** Abbreviation for 'twin-wire'.

## U

**Unbalanced audio:** A type of audio connection that utilises only two of the leads of a cable, connector and jack.

**Unfold:** Navigates the input channels of a group to the input bays.

**USB:** Abbreviation for 'universal serial bus'. A 'plug and play' interface that provides a fast connection between a computer and peripherals, such as keyboards, printers, scanners, digital cameras etc.

## V

**VCA:** Abbreviation for 'variable control association' (also 'voltage controlled amplifier').

**VCA fader:** The fader control of a VCA group.

**VCA group:** A group of channels that are controlled globally, such as via their group's fader and other controls. Provides an easy and quick method of manipulating and controlling the numerous channels available on the M32 Control Centre.

**VGA:** Abbreviation for 'video graphics array'. A graphics display system for PCs developed by IBM.

**Virtual rack:** A traditional 19" rack, represented on the GUI. A virtual rack will, typically, contain internal devices, such as effects and GEQs.

**Volt (V):** A unit of electrical potential differential or electromotive force.

**Volume:** General term for a signal's loudness.

## W

**Window:** A small self-contained panel that appears on the GUI, usually after selection of a specific control. Typically, contains a number of user-selectable options or information in the form of a message or prompt.

## X

**X-over:** Abbreviation for 'crossover'.

**XLR connector:** High-quality three-pin audio connector, which is also used for AES/EBU digital audio connections.

# EN Other important information

## EN Important information

**1. Register online.** Please register your new MUSIC Group equipment right after you purchase it by visiting [midasconsoles.com](http://midasconsoles.com). Registering your purchase using our simple online form helps us to process your repair claims more quickly and efficiently. Also, read the terms and conditions of our warranty, if applicable.

**2. Malfunction.** Should your MUSIC Group Authorized Reseller not be located in your vicinity, you may contact the MUSIC Group Authorized Fulfiller for your country listed under "Support" at [midasconsoles.com](http://midasconsoles.com). Should your country not be listed, please check if your problem can be dealt with by our "Online Support" which may also be found under "Support" at [midasconsoles.com](http://midasconsoles.com). Alternatively, please submit an online warranty claim at [midasconsoles.com](http://midasconsoles.com) BEFORE returning the product.

**3. Power Connections.** Before plugging the unit into a power socket, please make sure you are using the correct mains voltage for your particular model. Faulty fuses must be replaced with fuses of the same type and rating without exception.

## FR Informations importantes

**1. Enregistrez-vous en ligne.** Prenez le temps d'enregistrer votre produit MUSIC Group aussi vite que possible sur le site Internet [midasconsoles.com](http://midasconsoles.com). Le fait d'enregistrer le produit en ligne nous permet de gérer les réparations plus rapidement et plus efficacement. Prenez également le temps de lire les termes et conditions de notre garantie.

**2. Dysfonctionnement.** Si vous n'avez pas de revendeur MUSIC Group près de chez vous, contactez le distributeur MUSIC Group de votre pays : consultez la liste des distributeurs de votre pays dans la page "Support" de notre site Internet [midasconsoles.com](http://midasconsoles.com). Si votre pays n'est pas dans la liste, essayez de résoudre votre problème avec notre "aide en ligne" que vous trouverez également dans la section "Support" du site [midasconsoles.com](http://midasconsoles.com). Vous pouvez également nous faire parvenir directement votre demande de réparation sous garantie par Internet sur le site [midasconsoles.com](http://midasconsoles.com) AVANT de nous renvoyer le produit.

**3. Raccordement au secteur.** Avant de relier cet équipement au secteur, assurez-vous que la tension secteur de votre région soit compatible avec l'appareil. Veillez à remplacer les fusibles uniquement par des modèles exactement de même taille et de même valeur électrique — sans aucune exception.

## PT Outras Informações Importantes

**1. Registre-se online.** Por favor, registre seu novo equipamento MUSIC Group logo após a compra visitando o site [midasconsoles.com](http://midasconsoles.com). Registrar sua compra usando nosso simples formulário online nos ajuda a processar seus pedidos de reparos com maior rapidez e eficiência. Além disso, leia nossos termos e condições de garantia, caso seja necessário.

**2. Funcionamento Defeituoso.** Caso seu fornecedor MUSIC Group não esteja localizado nas proximidades, você pode contatar um distribuidor MUSIC Group para o seu país listado abaixo de "Suporte" em [midasconsoles.com](http://midasconsoles.com). Se seu país não estiver na lista, favor checar se seu problema pode ser resolvido com o nosso "Suporte Online" que também pode ser achado abaixo de "Suporte" em [midasconsoles.com](http://midasconsoles.com). Alternativamente, favor enviar uma solicitação de garantia online em [midasconsoles.com](http://midasconsoles.com) ANTES da devolução do produto.

**3. Ligações.** Antes de ligar a unidade à tomada, assegure-se de que está a utilizar a voltagem correcta para o modelo em questão. Os fusíveis com defeito terão de ser substituídos, sem qualquer excepção, por fusíveis do mesmo tipo e corrente nominal.

## ES Aspectos importantes

**1. Registro online.** Le recomendamos que registre su nuevo aparato MUSIC Group justo después de su compra accediendo a la página web [midasconsoles.com](http://midasconsoles.com). El registro de su compra a través de nuestro sencillo sistema online nos ayudará a resolver cualquier incidencia que se presente a la mayor brevedad posible. Además, aproveche para leer los términos y condiciones de nuestra garantía, si es aplicable en su caso.

**2. Averías.** En el caso de que no exista un distribuidor MUSIC Group en las inmediaciones, puede ponerse en contacto con el distribuidor MUSIC Group de su país, que encontrará dentro del apartado "Support" de nuestra página web [midasconsoles.com](http://midasconsoles.com). En caso de que su país no aparezca en ese listado, acceda a la sección "Online Support" (que también encontrará dentro del apartado "Support" de nuestra página web) y compruebe si su problema aparece descrito y solucionado allí. De forma alternativa, envíenos a través de la página web una solicitud online de soporte en periodo de garantía ANTES de devolvernos el aparato.

**3. Conexiones de corriente.** Antes de enchufar este aparato a una salida de corriente, asegúrese de que dicha salida sea del voltaje adecuado para su modelo concreto. En caso de que deba sustituir un fusible quemado, deberá hacerlo por otro de idénticas especificaciones, sin excepción.

## DE Weitere wichtige Informationen

**1. Online registrieren.** Bitte registrieren Sie Ihr neues MUSIC Group-Gerät direkt nach dem Kauf auf der Website [midasconsoles.com](http://midasconsoles.com). Wenn Sie Ihren Kauf mit unserem einfachen online Formular registrieren, können wir Ihre Reparaturansprüche schneller und effizienter bearbeiten. Lesen Sie bitte auch unsere Garantiebedingungen, falls zutreffend.

**2. Funktionsfehler.** Sollte sich kein MUSIC Group Händler in Ihrer Nähe befinden, können Sie den MUSIC Group Vertrieb Ihres Landes kontaktieren, der auf [midasconsoles.com](http://midasconsoles.com) unter „Support“ aufgeführt ist. Sollte Ihr Land nicht aufgelistet sein, prüfen Sie bitte, ob Ihr Problem von unserem „Online Support“ gelöst werden kann, den Sie ebenfalls auf [midasconsoles.com](http://midasconsoles.com) unter „Support“ finden. Alternativ reichen Sie bitte Ihren Garantieanspruch online auf [midasconsoles.com](http://midasconsoles.com) ein, BEVOR Sie das Produkt zurücksenden.

**3. Stromanschluss.** Bevor Sie das Gerät an eine Netzsteckdose anschließen, prüfen Sie bitte, ob Sie die korrekte Netzspannung für Ihr spezielles Modell verwenden. Fehlerhafte Sicherungen müssen ausnahmslos durch Sicherungen des gleichen Typs und Nennwerts ersetzt werden.

## JP その他の重要な情報

**1. ヒューズの格納部 / 電圧の選択:** ユニットをパワーソケットに接続する前に、各モデルに対応した正しい主電源を使用していることを確認してください。ユニットによっては、230V と 120V の 2 つの違うポジションを切り替えて使う、ヒューズの格納部を備えているものがあります。正しくない値のヒューズは、絶対に適切な値のヒューズに交換されている必要があります。

**2. 故障:** MUSIC Group デイラーがお客様のお近くにはないときは、[midasconsoles.com](http://midasconsoles.com) の "Support" 内に列記されている、お客様の国の MUSIC Group ディストリビューターにコンタクトすることができます。お客様の国がリストにない場合は、同じ [midasconsoles.com](http://midasconsoles.com) の "Support" 内にある "Online Support" でお客様の問題が処理できないか、チェックしてみてください。あるいは、商品を返送する前に、[midasconsoles.com](http://midasconsoles.com) で、オンラインの保証請求を要請してください。

**3. 電源接続:** 電源ソケットに電源コードを接続する前に、本製品に適切な電圧を使用していることをご確認ください。不具合が発生したヒューズは必ず電圧および電流、種類が同じヒューズに交換する必要があります。

**CN 其他的重要信息**

- 1. 在线注册。**请购买 MUSIC Group 产品后立即在 [midasconsoles.com](http://midasconsoles.com) 网站注册。网页上有简单的在线注册表格。这有助于我们更快更有效率地处理您维修等事宜。请阅读保修的相关条款及条件。
- 2. 无法正常工作。**若您的 MUSIC Group 产品无法正常工作,我们会为您尽快修复。请联系您购买产品的销售商。若你所在地区没有 MUSIC Group 销售商,请联系 [midasconsoles.com](http://midasconsoles.com) 网站的“WHERE TO BUY”一栏下的所列出的子公司或经销商。
- 3. 电源连接。**将本设备连接电源前,请确保使用的电压正确。保险丝需要更换时,必须使用相同型号及定额的保险丝。

# FEDERAL COMMUNICATIONS COMMISSION COMPLIANCE INFORMATION



Responsible Party Name: **MUSIC Group Research  
UK Limited**

Address: **Klark Industrial Park,  
Walter Nash Road,  
Kidderminster. Worcestershire.  
DY11 7HJ. England.**

Phone Number: **+44 1562 741515**

## **M32 DIGITAL CONSOLE**

complies with the FCC rules as mentioned in the following paragraph:

This equipment has been tested and found to comply with the limits for a Class A digital device, pursuant to Part 15 of the FCC Rules. These limits are designed to provide reasonable protection against harmful interference when the equipment is operated in a commercial environment. This equipment generates, uses, and can radiate radio frequency energy and, if not installed and used in accordance with the instruction manual, may cause harmful interference to radio communications. Operation of this equipment in a residential area is likely to cause harmful interference in which case the user will be required to correct the interference at his own expense.

### **Important information:**

Changes or modifications to the equipment not expressly approved by MUSIC Group can void the user's authority to use the equipment.

