

RMP-D8

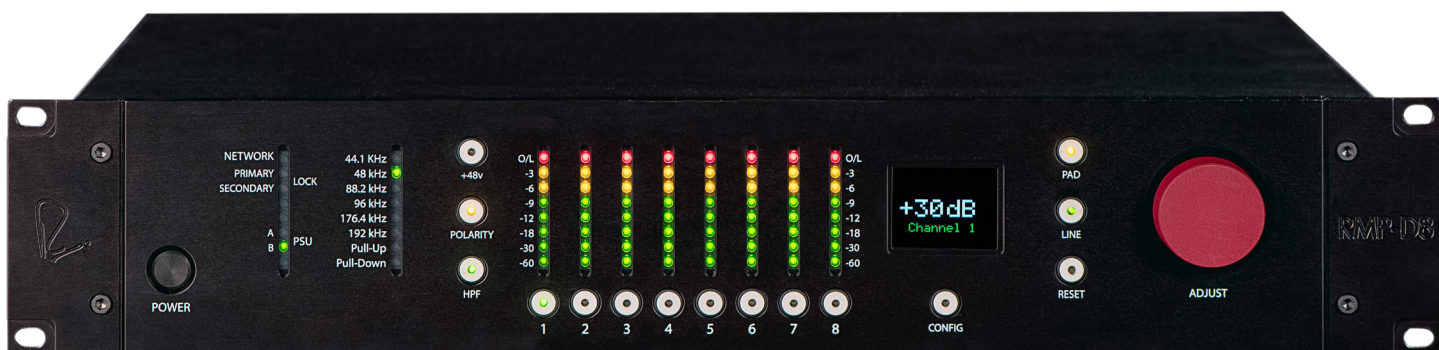

8 Channel Dante™ Microphone Preamp

Serial Number:



Operations Manual

Important Safety Instructions

1. Read these instructions.
2. Keep these instructions.
3. Heed all warnings.
4. Follow all instructions.
5. Do not use this apparatus near water.
6. Clean only with a dry cloth.
7. Do not block any ventilation openings. Install in accordance with the manufacturer's instructions.
8. Do not install near any heat sources such as radiators, heat registers, stoves, or other apparatus (including amplifiers) that produce heat.
9. Do not defeat the safety purpose of the polarized or grounding-type plug. A polarized plug has two blades with one wider than the other. A grounding-type plug has two blades and a third grounding prong. The wide blade or the third prong are provided for your safety. If the provided plug does not fit into your outlet, consult an electrician for replacement of the obsolete outlet.
10. Protect the power cord from being walked on or pinched particularly at plugs, convenience receptacles, and the point where they exit from the apparatus.
11. Only use attachments/accessories specified by the manufacturer.
12. Use only with a cart, stand, tripod, bracket, or table specified by the manufacturer, or sold with the apparatus. When a cart is used, use caution when moving the cart/apparatus combination to avoid injury from tip-over.
13. Unplug this apparatus during lightning storms or when unused for long periods of time.
14. Refer all servicing to qualified service personnel. Servicing is required when the apparatus has been damaged in any way, such as power-supply cord or plug is damaged, liquid has been spilled or objects have fallen into the apparatus, the apparatus has been exposed to rain or moisture, does not operate normally, or has been dropped.
15. This apparatus shall not be exposed to dripping or splashing, and no object filled with liquids, such as vases or beer glasses, shall be placed on the apparatus.
16. Do not overload wall outlets and extension cords as this can result in a risk of fire or electric shock.
17. This apparatus has been designed with Class-I construction and must be connected to a mains socket outlet with a protective earthing connection (the third grounding prong).
18. This apparatus has been equipped with a rocker-style AC mains power switch. This switch is located on the rear panel and should remain readily accessible to the user.
19. The MAINS plug or an appliance coupler is used as the disconnect device, so the disconnect device shall remain readily operable.



20. NOTE: This equipment has been tested and found to comply with the limits for a Class B digital device, pursuant to part 15 of the FCC Rules. These limits are designed to provide reasonable protection against harmful interference in a residential installation. This equipment generates, uses, and can radiate radio frequency energy and, if not installed and used in accordance with the instructions, may cause harmful interference to radio communications. However, there is no guarantee that interference will not occur in a particular installation. If this equipment does cause harmful interference to radio or television reception, which can be determined by turning the equipment off and on, the user is encouraged to try to correct the interference by one or more of the following measures:

- Reorient or relocate the receiving antenna.
- Increase the separation between the equipment and the receiver.
- Connect the equipment into an outlet on a circuit different from that to which the receiver is connected.
- Consult the dealer or an experienced radio/TV technician for help.

CAUTION: Changes or modifications to this device not expressly approved by Rupert Neve Designs LLC, could void the user's authority to operate the equipment under FCC rules.

21. This apparatus does not exceed the Class A/Class B (whichever is applicable) limits for radio noise emissions from digital apparatus as set out in the radio interference regulations of the Canadian Department of Communications.

ATTENTION — *Le présent appareil numérique n'émet pas de bruits radioélectriques dépassant les limites applicables aux appareils numériques de class A/de class B (selon le cas) prescrites dans le règlement sur le brouillage radioélectrique édicté par les ministere des communications du Canada.*

22. Exposure to extremely high noise levels may cause permanent hearing loss. Individuals vary considerably in susceptibility to noise-induced hearing loss, but nearly everyone will lose some hearing if exposed to sufficiently intense noise for a period of time. The U.S. Government's Occupational Safety and Health Administration (OSHA) has specified the permissible noise level exposures shown in the following chart. According to OSHA, any exposure in excess of these permissible limits could result in some hearing loss. To ensure against potentially dangerous exposure to high sound pressure levels, it is recommended that all persons exposed to equipment capable of producing high sound pressure levels use hearing protectors while the equipment is in operation. Ear plugs or protectors in the ear canals or over the ears must be worn when operating the equipment in order to prevent permanent hearing loss if exposure is in excess of the limits set forth here:



The lightning flash with arrowhead symbol within an equilateral triangle is intended to alert the user to the presence of uninsulated "dangerous voltage" within the product's enclosure, that may be of sufficient magnitude to constitute a risk of electric shock to persons.
Le symbole éclair avec point de flèche à l'intérieur d'un triangle équilatéral est utilisé pour alerter l'utilisateur de la présence à l'intérieur du coffret de "voltage dangereux" non isolé d'ampleur suffisante pour constituer un risque d'électrocution.

The exclamation point within an equilateral triangle is intended to alert the user of the presence of important operating and maintenance (servicing) instructions in the literature accompanying the appliance.
Le point d'exclamation à l'intérieur d'un triangle équilatéral est employé pour alerter les utilisateurs de la présence d'instructions importantes pour le fonctionnement et l'entretien (service) dans le livret d'instruction accompagnant l'appareil.

Duration, per day in hours	Sound Level dBA, Slow Response	Typical Example
8	90	Duo in small club
6	92	
4	95	Subway Train
3	97	
2	100	Typical music via head phones
1.5	102	
1	105	Siren at 10 m distance
0.5	110	
0.25 or less	115	Loudest parts at a rock concert

WARNING — To reduce the risk of fire or electric shock, do not expose this apparatus to rain or moisture.

Table of Contents

Introduction	1
Block Diagram	1
Front Panel	2
Rear Panel	3
RMP-D8 Features	4
Network Connectivity	5
OLED Display	6
Dante Controller	8
Gain Compensation	10
Application Remote Control	11
Dante Domain Manager	15
Yamaha ID	16
USB Firmware Update	17
Specifications	18
Limited Warranty	19

Rupert Neve Designs RMP-D8 Dante™ Microphone Preamp

Thank you for purchasing the Rupert Neve Designs RMP-D8. We hope you enjoy using this product as much as we have enjoyed designing and building it. The RMP-D8 represents the culmination of several years of analog and digital development, successfully merging custom-designed Rupert Neve Class-A analog circuitry, high-quality 24-bit Analog to Digital conversion and Dante™ network audio connectivity. This unit takes advantage of transformer coupling in the analog path to give the RMP-D8 its unique sonic profile. The combination of these performance characteristics allows the Rupert Neve Designs RMP-D8 to find itself equally comfortable in both live venue and studio applications.

RMP-D8 Block Diagram

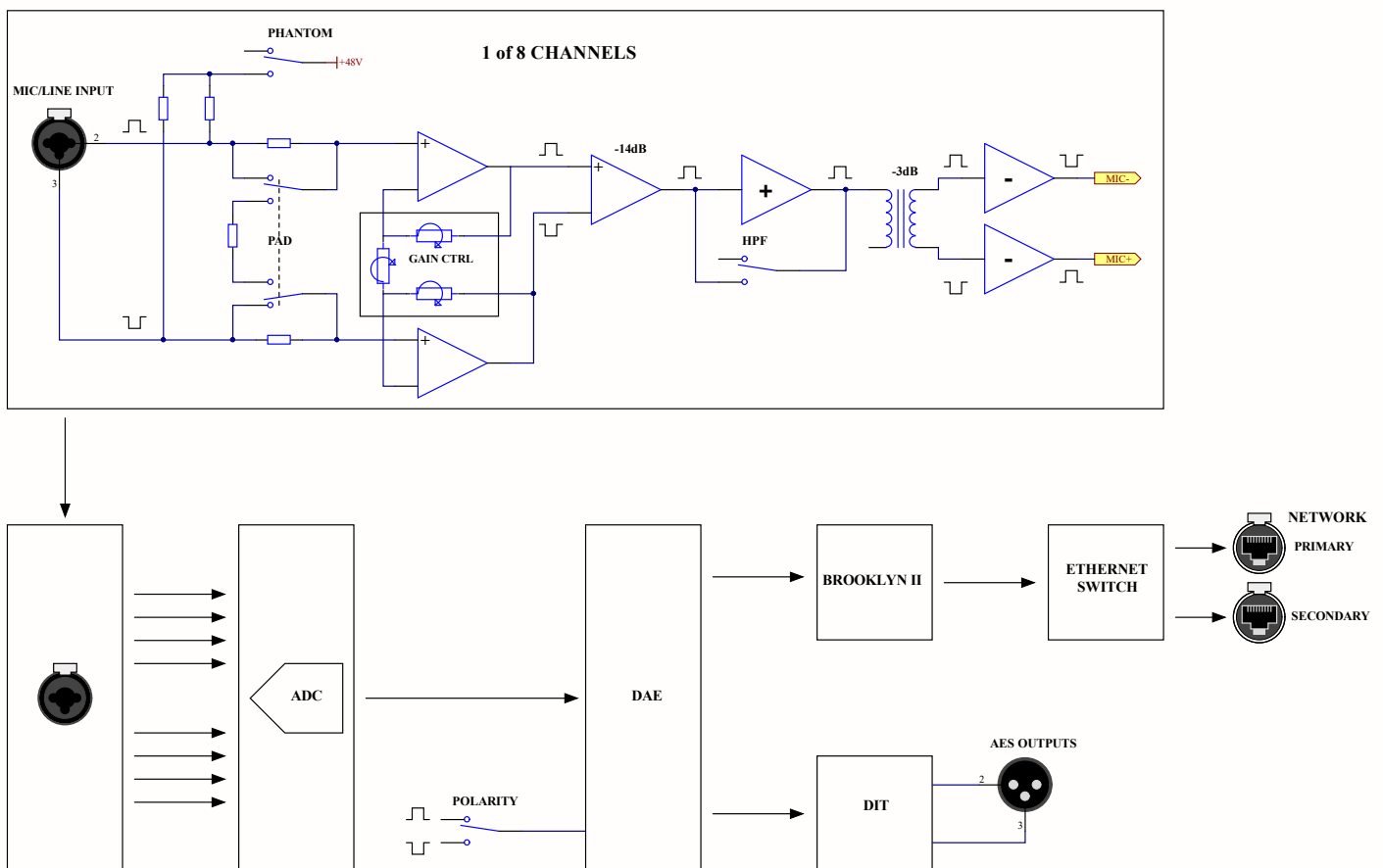

RMP-D8 Front Panel

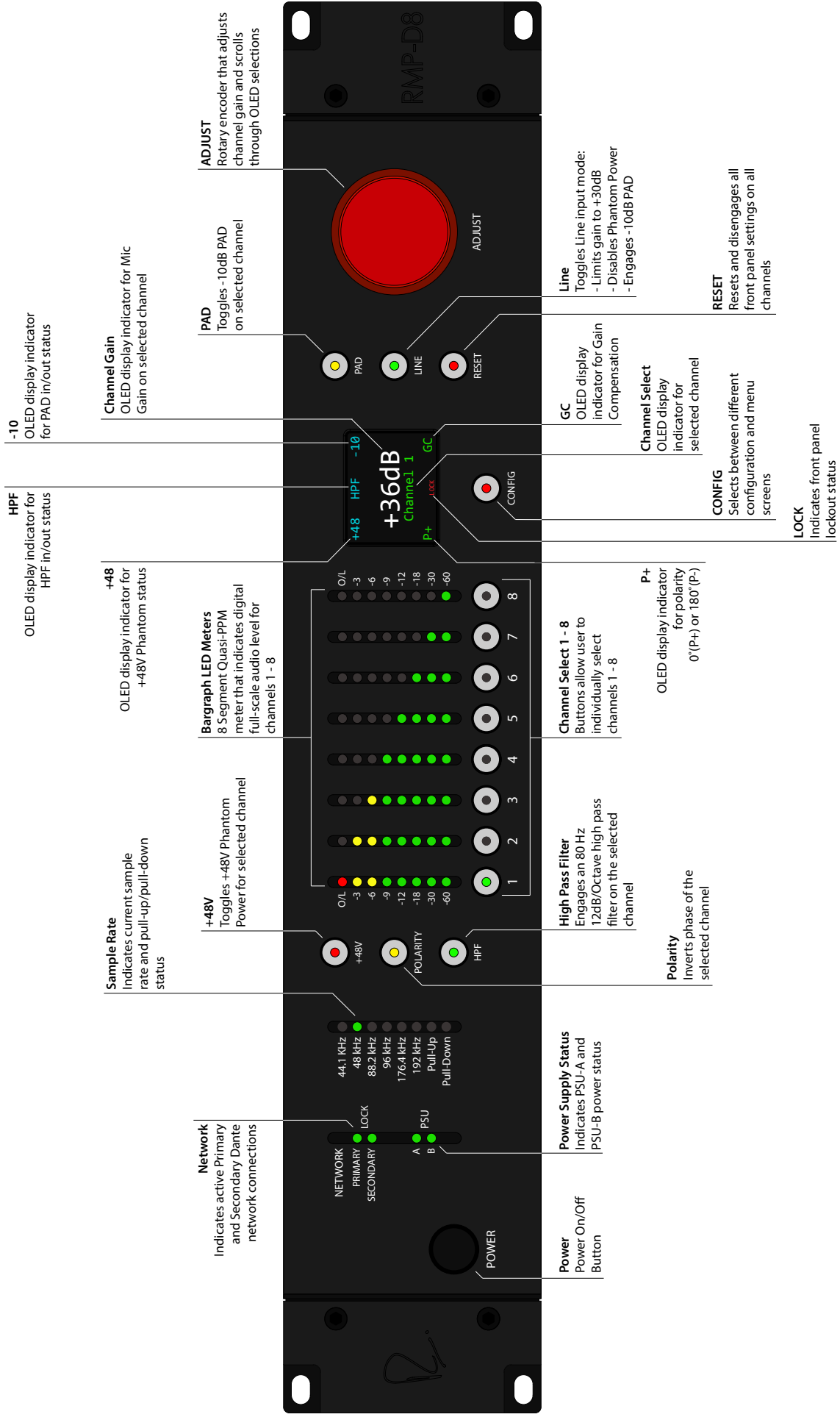

RMP-D8 Rear Panel

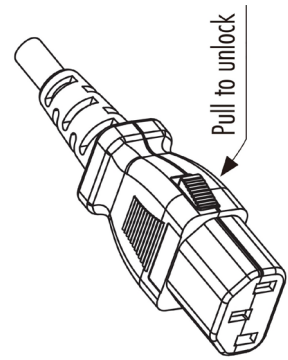
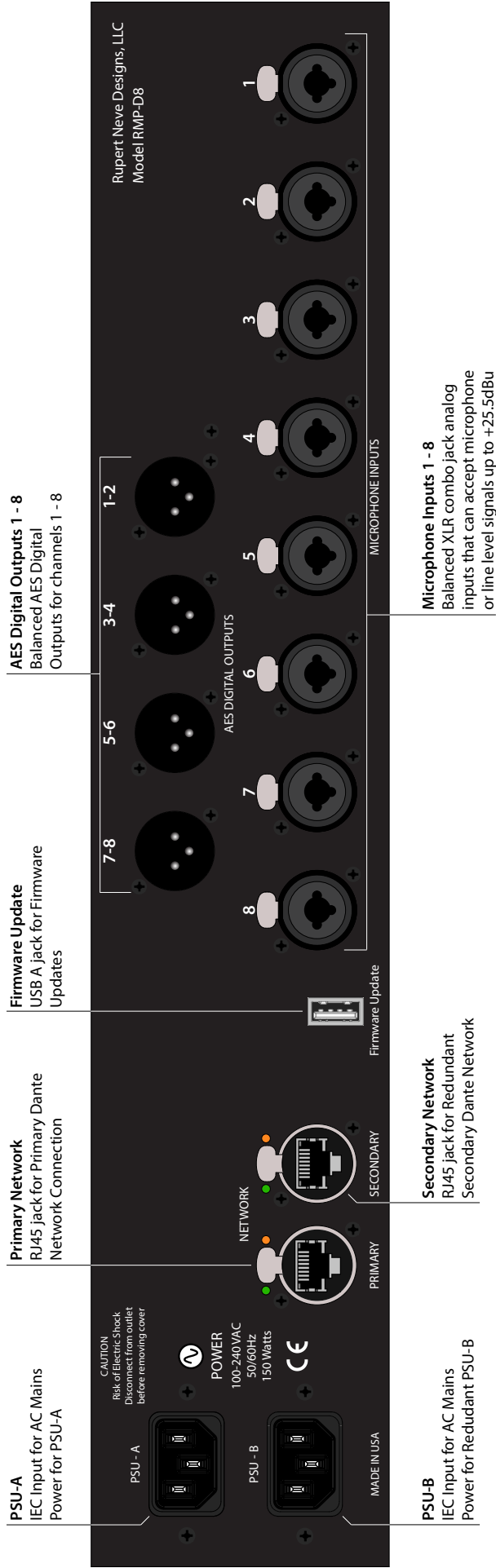

Note: IEC power cords provided are latching type.

RMP-D8 Front Panel Features

Eight Segment LED Channel Metering

The RMP-D8 is equipped with 8-segment Bargraph LED meters for each input channel (1 through 8). These meters are scaled to represent a Quasi-Peak Programme (PPM) metering ballistic for optimal resolution. The front panel metering indicates the post ADC level in digital full-scale level from -60dBFS to 0dBFS.

LINE

Engaging LINE MODE on the RMP-D8 automatically selects the following features:

- PAD is engaged by default (-10dB)
- Phantom Power (+48VDC) is disabled to prevent potential fault conditions
- Individual channel gain is restricted to a maximum of +30dB to prevent potential input overload

RESET

If the RESET button is pressed on the RMP-D8 front panel, the user will be prompted with the following message on the front panel OLED display:

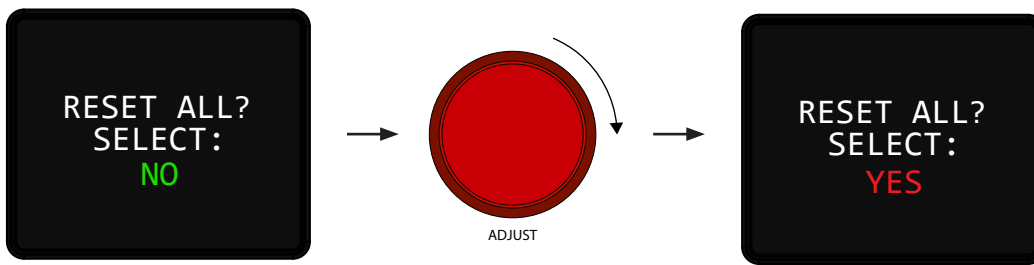

Rotate the ADJUST encoder wheel *one* detent clock-wise until the OLED screen prompts “YES.” Press the RESET button again to accept the changes. The RMP-D8 will fully reset to its default state (all features disengaged and channel gain settings reset to 0dB).

Front Panel Lockout

The RMP-D8 allows the user to lockout the front panel by executing a simple front panel button combination:

PRESS IN and HOLD down the ADJUST rotary encoder (STEP 1). While holding the ADJUST encoder down, press the RESET button once (STEP 2). The LOCK icon will appear on the bottom middle of the OLED display indicating successful front panel lockout. To disengage front panel lockout at any time, repeat steps 1 and 2.

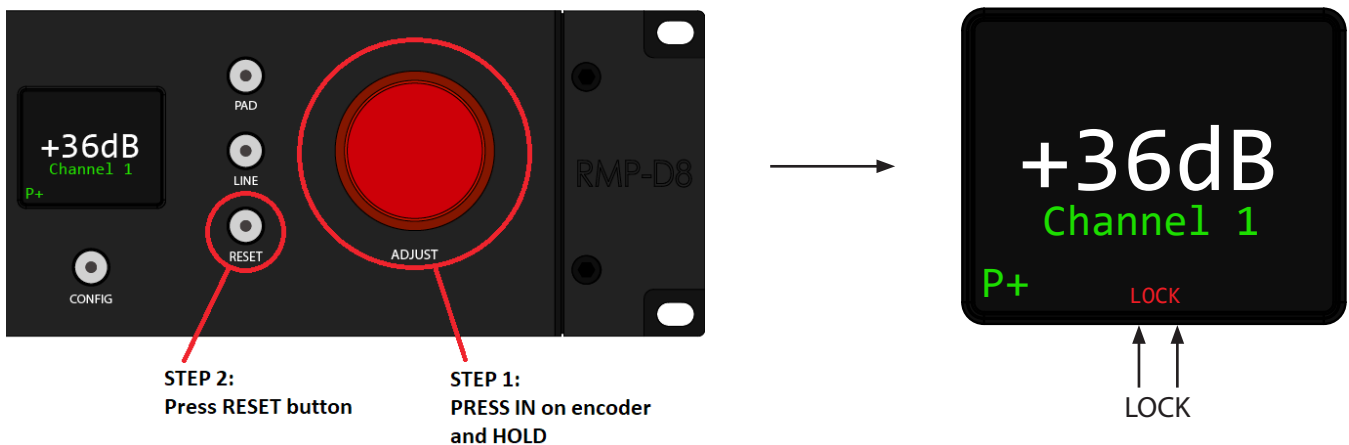

RMP-D8 Network Connectivity

The RMP-D8 has a Primary Dante Network Port as well as a redundant Secondary Dante Network Port. The Primary Port provides the main Dante Network connectivity, as well as connection to Dante Controller running on your PC or MAC.

Note: A Gigabit Ethernet switch should be used to make all Dante network connections. See Audinate's Gigabit Ethernet switch recommendations available on their website.

The RMP-D8 Secondary Dante Network Port is available for Redundant network applications, acting as a failsafe if the Primary Network fails. All Secondary Dante Network connections must be made through a separate Gigabit Ethernet switch.

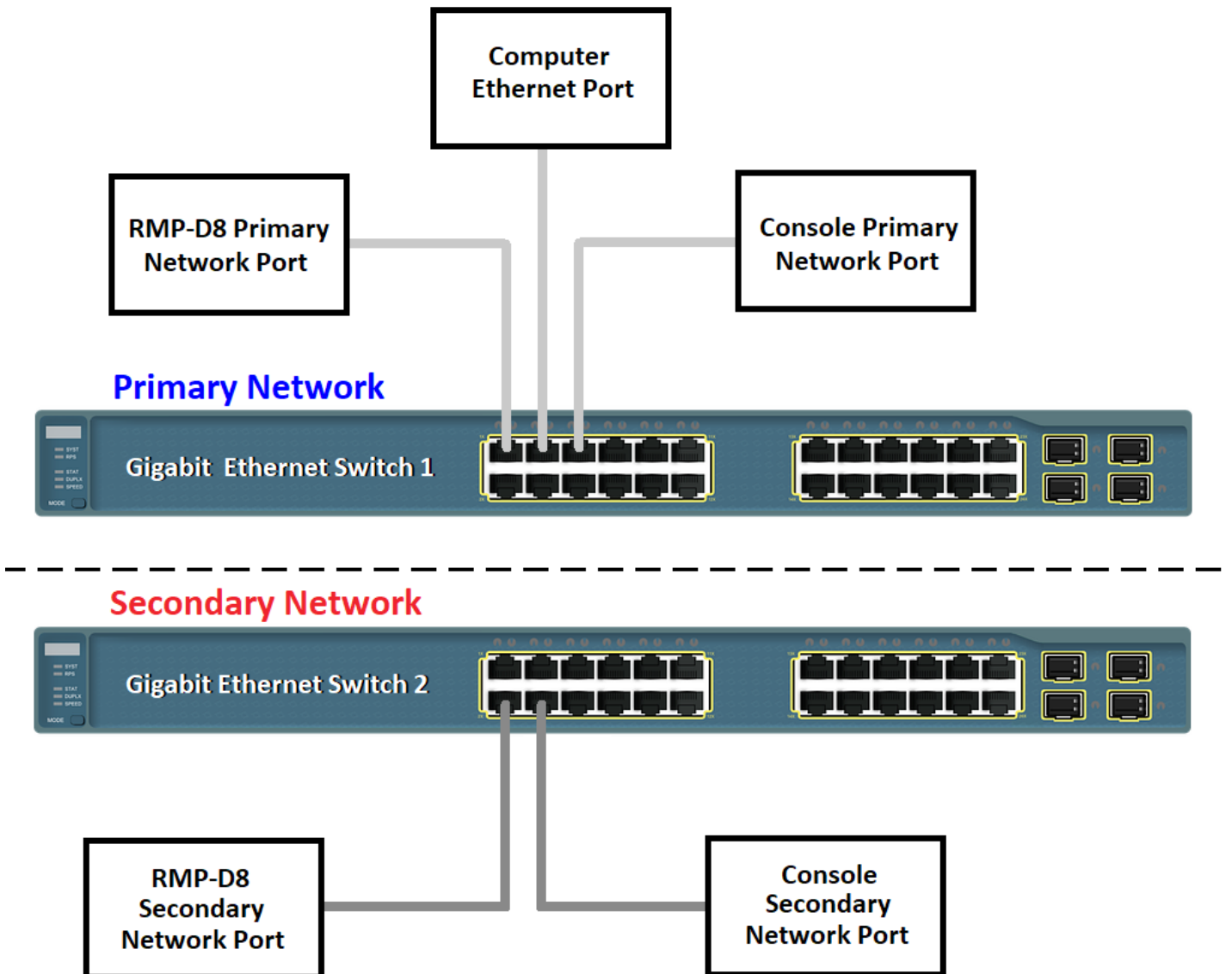

RMP-D8 OLED Display

The RMP-D8 utilizes a front panel OLED display screen for multiple menu functions. The default operational screen will show the current status of the selected channel, including: Channel Gain, +48V Phantom status (+48), PAD status (-10), Polarity status (P+), HPF status (HPF), Front Panel Lockout (LOCK), and Gain Compensation status (GC).



In addition to front panel status indication for a selected channel, the OLED display also shows configuration menus, which can be accessed by repeatedly pressing the CONFIG front panel button directly underneath the OLED display screen.

Pressing the CONFIG button *once* will bring up the SYSTEM info screen:

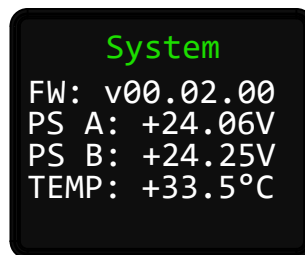

Pressing the CONFIG button *twice* will bring up the Dante Domain Manager info screen (Firmware v2.00 and later):

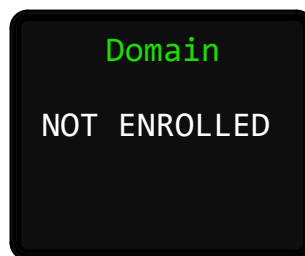

Pressing the CONFIG button a *third* time will bring up the Primary Network IP and MAC Address screen:

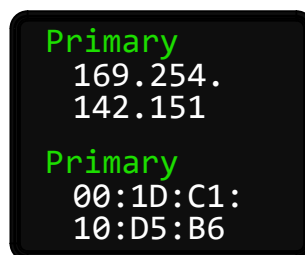

Pressing the CONFIG button a *fourth* time will bring up the Secondary Network IP and MAC Address screen:

```
Sec.  
172.31.  
142.152  
  
Sec.  
00:1D:C1:  
10:D5:B7
```

Pressing the CONFIG button a *fifth* time will bring up the Dante Software/Firmware info screen:

```
Dante  
SW: v 4.0.9  
Build: 1  
  
FW: v 4.0.2  
Build: 1
```

Pressing the CONFIG button a *sixth* time will bring up the Yamaha ID edit screen (see Yamaha ID section - page 16):

```
Yamaha ID:  
OFF  
EDIT?  
NO
```

Pressing the CONFIG button a *seventh* time will bring up the Dante ID info screen:

```
Dante ID  
Device Name:  
RND-RMP-D8-10  
D5B6
```

Pressing the CONFIG button an eighth time will bring you back to the standard operational status screen.

RMP-D8 and Dante Controller

In order to configure sample rate, bit depth, and Dante network audio routing, you will need to run Dante Controller on your PC or MAC computer. The RMP-D8 will identify in Dante Controller with the *same* Dante ID as seen on the OLED display in the Dante ID configuration menu.

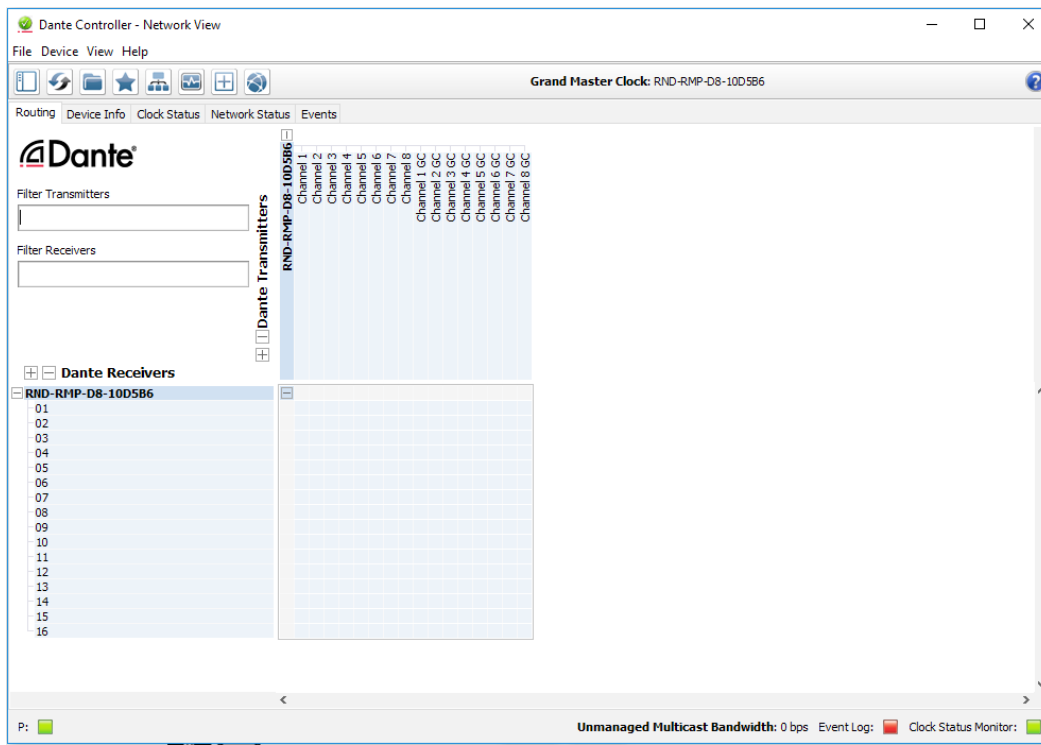

In order to change the RMP-D8 sample rate, bit depth, and pull-up/pull-down settings, double click on the RMP-D8 Device name in Dante Controller's routing tab to open the Dante Controller Device View Window.

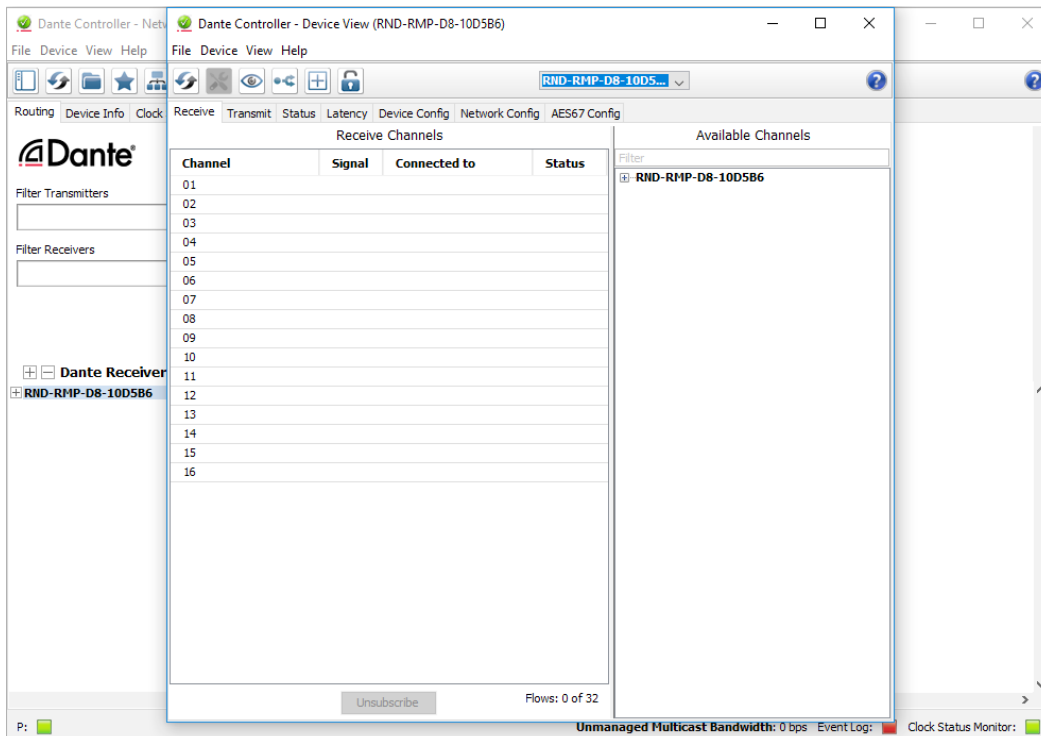

Within the Device View Window, click on the Device Config Tab:

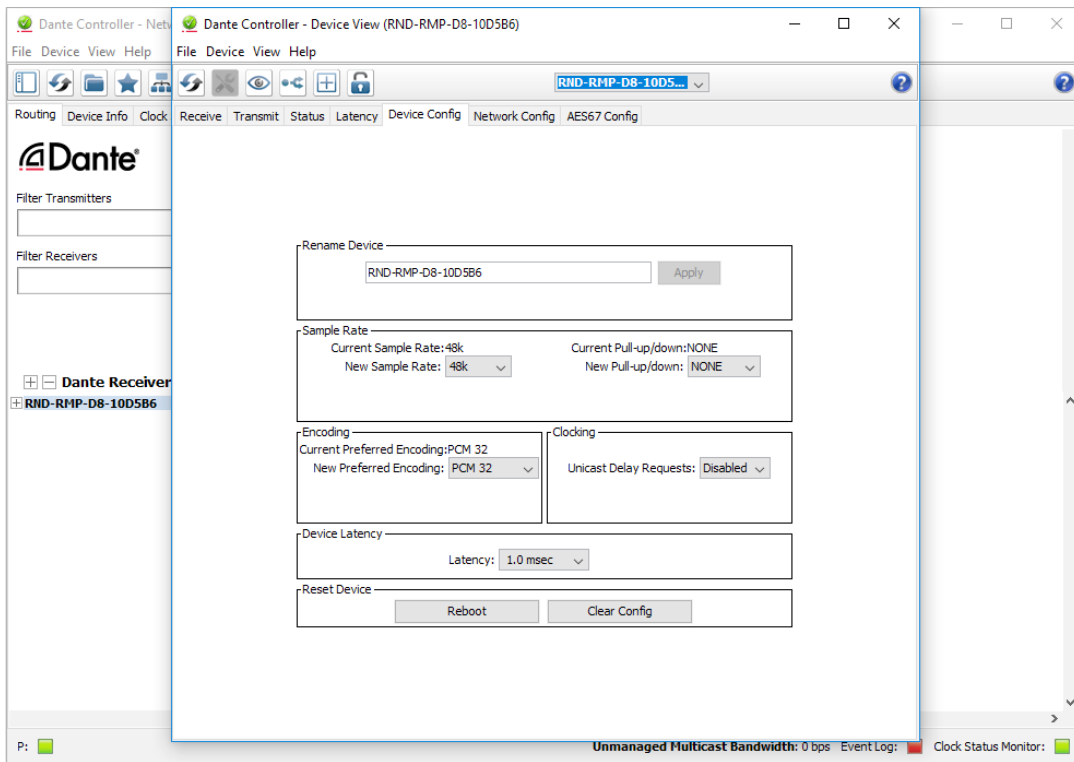

Within the Device Config Window, the user can adjust sample rate, bit depth, pull-up/pull-down and latency settings:

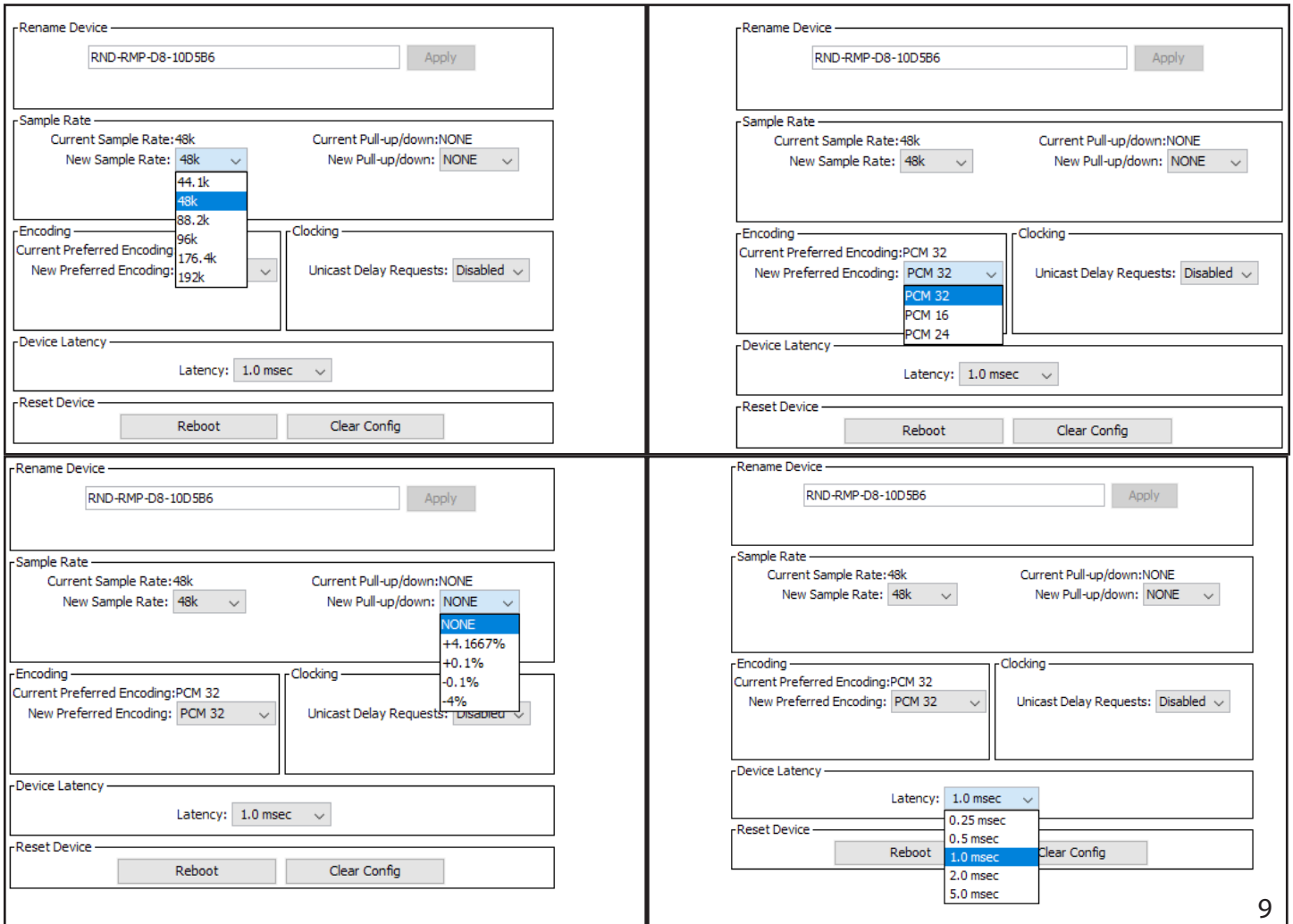

RMP-D8 Gain Compensation

The RMP-D8 has an available Gain Compensation (GC) mode that can be engaged on a channel by channel basis. RMP-D8 channels 1 through 8 are successively mirrored to RMP-D8 Dante Transmit channels 9 through 16 in Dante Controller. These mirrored outputs appear in Dante Controller on channels 9-16 identified as 'RMP-D8 Channel 1 GC Output' through 'RMP-D8 Channel 8 GC Output' and are output at an audio level which is pre-set to be 6dB below the set gain on each channel. This -6dB offset provides additional digital signal headroom to avoid clipping the gain compensated outputs. These mirrored channels can then be utilized as gain compensated outputs on a channel by channel basis by activating GC, once the desired nominal gain for each channel is set:

- RMP-D8 Channel 1 → Dante Transmit Channel 9, (RMP-D8 Channel 1 GC Output)
- RMP-D8 Channel 2 → Dante Transmit Channel 10, (RMP-D8 Channel 2 GC Output)
- RMP-D8 Channel 3 → Dante Transmit Channel 11, (RMP-D8 Channel 3 GC Output)
- RMP-D8 Channel 4 → Dante Transmit Channel 12, (RMP-D8 Channel 4 GC Output)
- RMP-D8 Channel 5 → Dante Transmit Channel 13, (RMP-D8 Channel 5 GC Output)
- RMP-D8 Channel 6 → Dante Transmit Channel 14, (RMP-D8 Channel 6 GC Output)
- RMP-D8 Channel 7 → Dante Transmit Channel 15, (RMP-D8 Channel 7 GC Output)
- RMP-D8 Channel 8 → Dante Transmit Channel 16, (RMP-D8 Channel 8 GC Output)

Setup:

Before entering gain compensation mode, adjust each channel's gain to the desired nominal gain level for the given input signal. Enter gain compensation mode by PRESSING and HOLDING the channel select button on the desired channel or by toggling the function on the remote user interface. Once gain compensation is engaged, the corresponding mirrored Dante Transmit channel will maintain a consistent level, compensated within a range of +/- 12dB of the primary channel being adjusted.

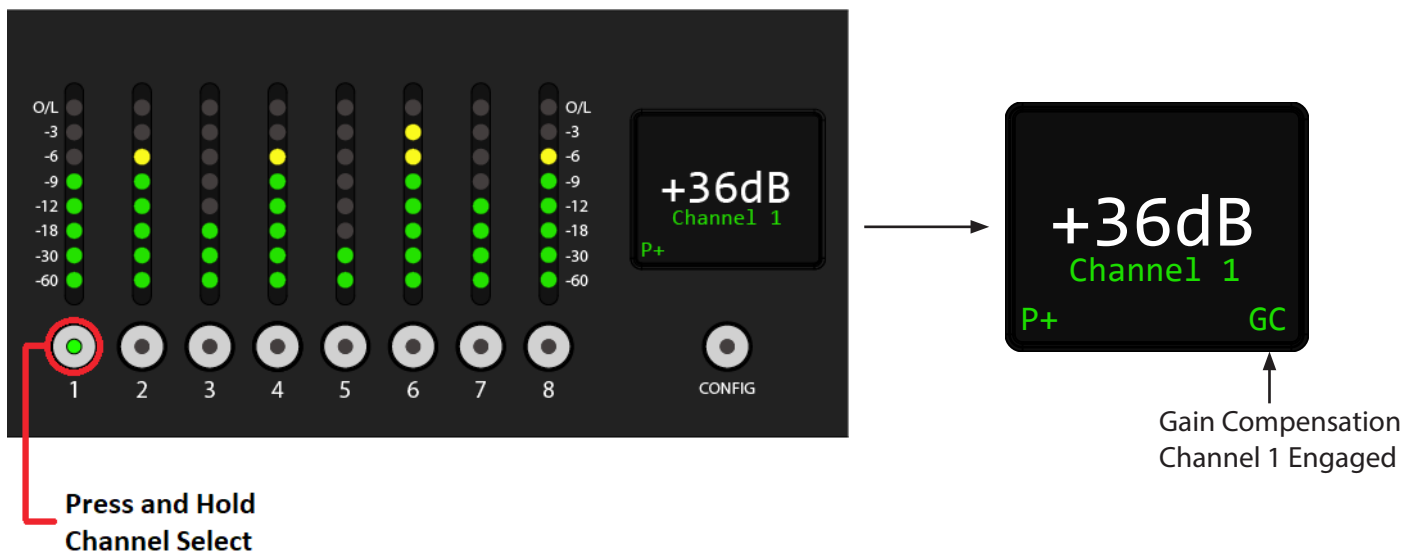

Application:

This feature becomes useful in the event that the FOH engineer needs to make a gain adjustment to a specific RMP-D8 channel (Channels 1-8), but does not want to affect the mirrored transmit channels going to the monitor engineer (Transmit Channels 9-16).

Example:

If Channel 1 is set to +36dB Gain before entering gain compensation mode, Channel 9's signal level will be 6dB below Channel 1.

Once Gain Compensation is engaged on Channel 1, Channel 9's level will maintain its gain setting as long as:

- The adjustment range does not exceed the +/-12dB Gain Compensation limits
- The required digital headroom is available to prevent clipping

In this example, the mirrored GC channel will remain at a +30dB gain level as long as the FOH engineer doesn't adjust the gain range beyond +/- 12dB of +36dB: the value that was set when GC mode was initially engaged.

Note: If the FOH engineer were to increase Channel 1's gain beyond +/- 12dB, Channel 9's gain compensated output would subsequently follow in 1dB increments.

Gain compensated outputs cannot exceed the limits of the 0 - 60 dB gain range available on the RMP-D8.

RMP-D8 Application Remote Control

The RMP-D8 has an available software application that can be used to remotely control the RMP-D8 feature set over the network.

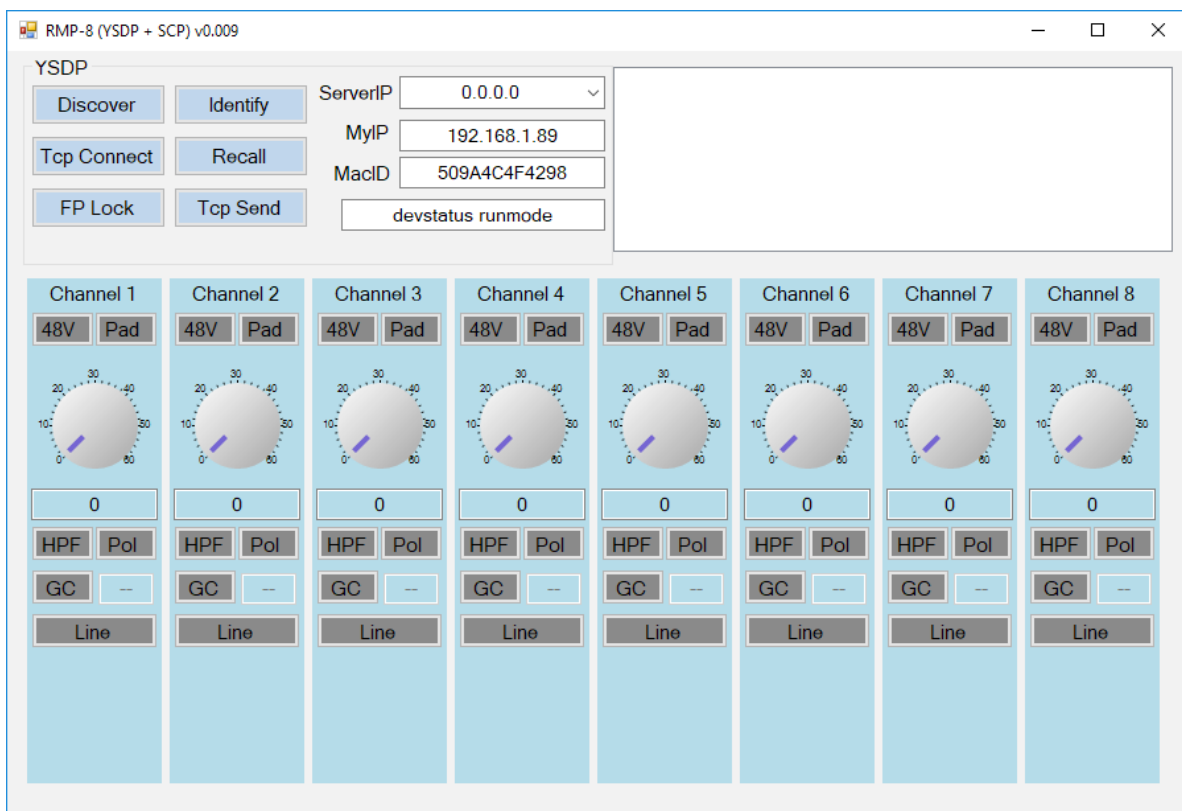

Initial Connection

Once the application is open, click on the DISCOVER button. This button will scan for all available RMP-D8 units that are currently active on the network. The ServerIP drop down menu will list all successfully discovered RMP-D8 units by their IP address.

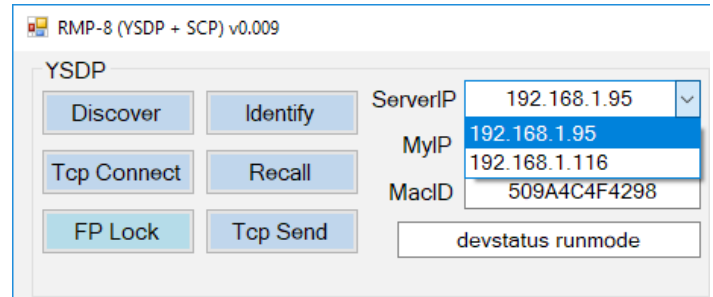
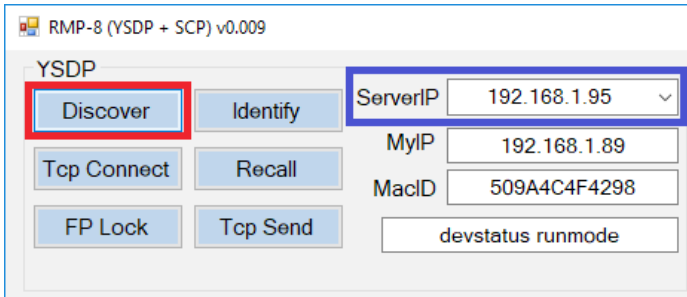

Once the correct RMP-D8 is selected from the drop-down ServerIP menu, click the TCP CONNECT button.

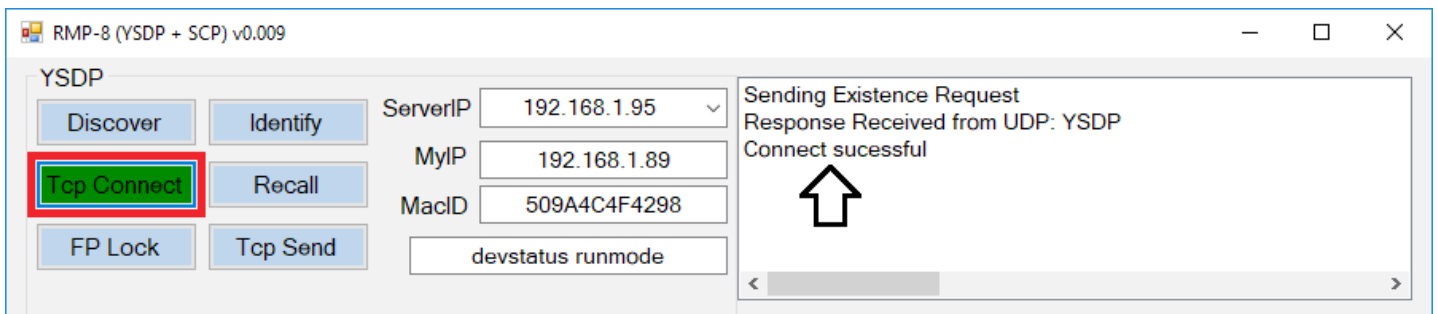

A successful connection will be indicated by a "Connect Successful" message in the run-time dialog window. To confirm which RMP-D8 is currently connected, the user can click on the IDENTIFY button. This will prompt the RMP-D8 to flash all eight channel select buttons repeatedly on the RMP-D8 front panel, until the IDENTIFY button is deselected.

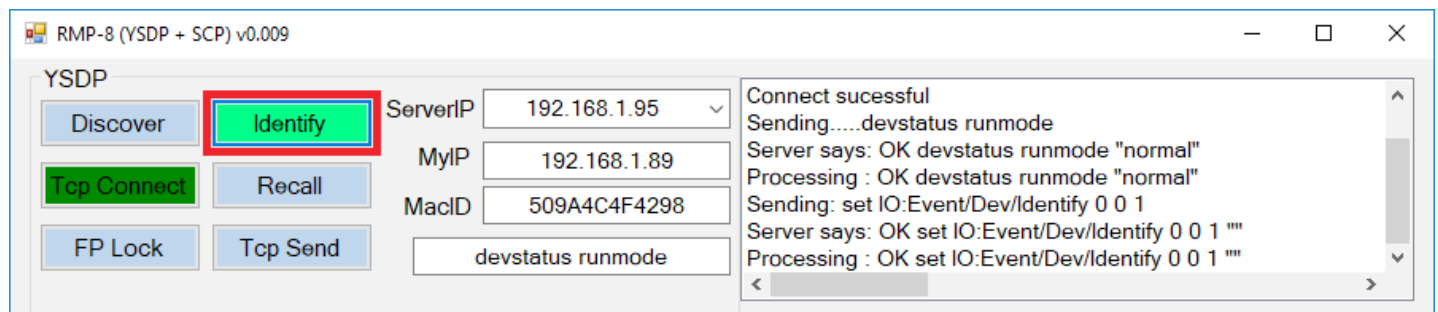

After verifying successful connection, the user should click on the RECALL button to recall the current status of all the features on the selected RMP-D8.

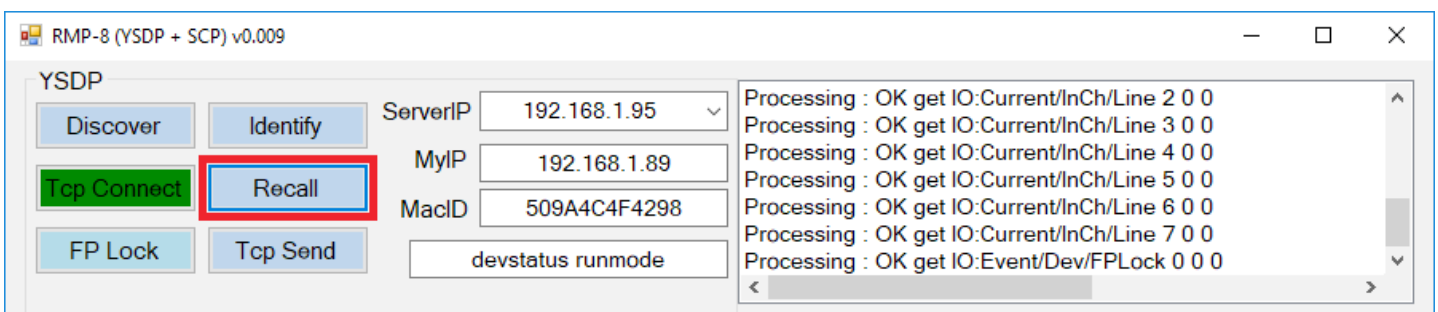

After pressing the RECALL button, the GUI will update all current features engaged and settings on all eight channels.

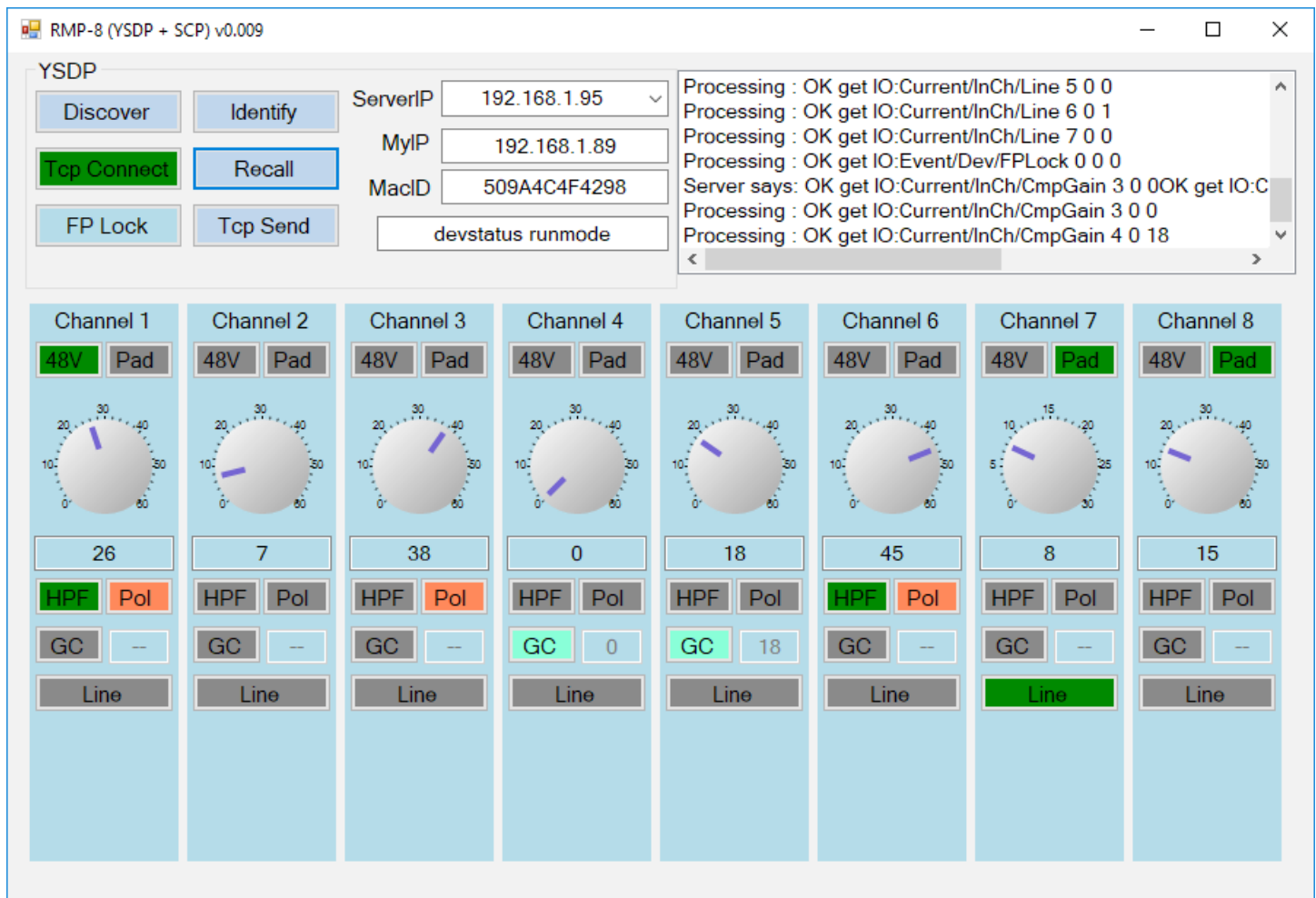

Connecting to Additional RMP-D8 Units

To connect to a different RMP-D8, click on the TCP CONNECT button a second time to disconnect.



Once disconnected, navigate to the ServerIP dropdown menu, select the IP address of another RMP-D8 and click the TCP CONNECT button once again to connect to the newly selected RMP-D8.

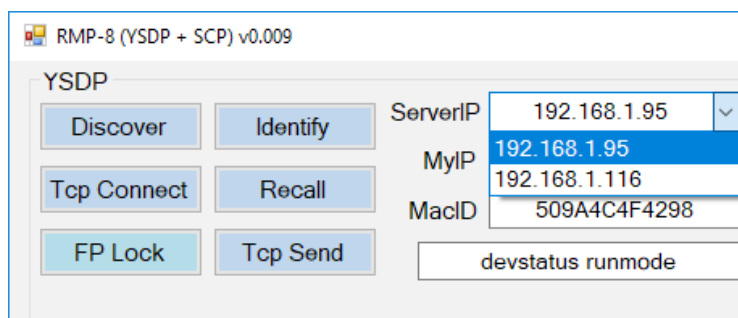

Once the TCP CONNECT button is illuminated and a "Connect Successful" message has been received, click on the RECALL button to recall the current status of the connected RMP-D8.

Basic Application Operation

Clicking once on any channel's gain knob will make that channel's gain knob active (highlighted). Clicking repeatedly on the channel gain knob will increment the channel gain by +1dB for each click. The user can also click in the box directly below the channel gain knob and type in the desired value for quick and precise gain adjustments.

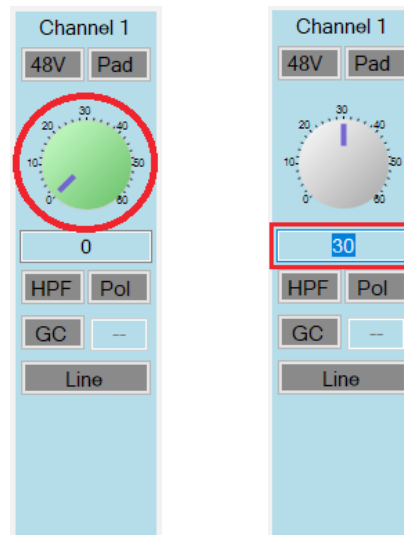

The rest of the channel features are explained in other sections of the manual. For reference, the various features that can be engaged in the application are graphically shown below.

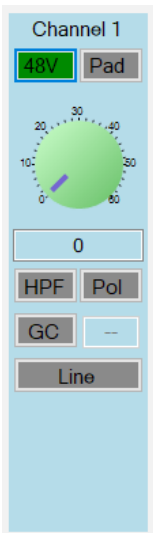

+48V
(Page 2)

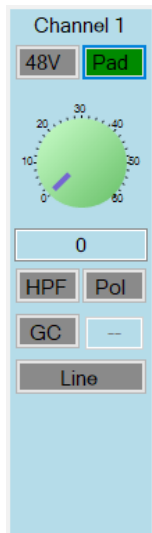

-10dB PAD
(Page 2)

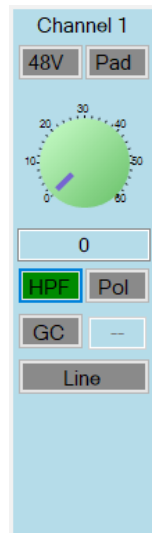

80Hz HPF
(Page 2)

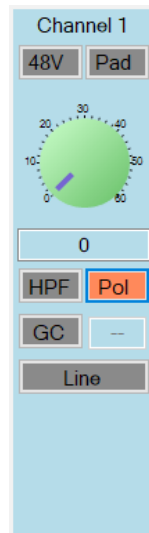

Polarity
(Page 2)

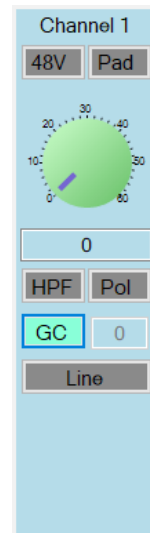

Gain Compensation
(Page 11)

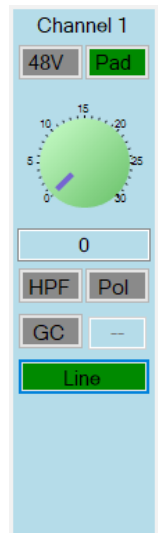

Line Mode
(Page 4)

Note: When Line Mode is engaged in the application, the available Channel Gain range indicated is limited to +30dB and the PAD is automatically engaged.

Application Front Panel Lockout

In addition to the RMP-D8 front panel button combination for Front Panel Lockout (see page 5), the user can also remotely lock the Front Panel within the application:

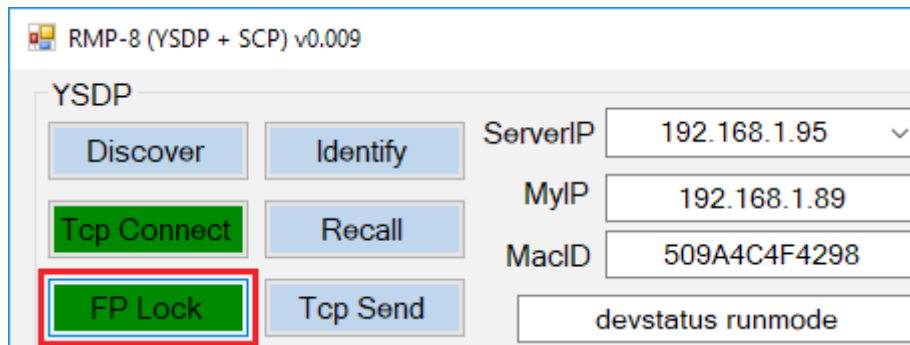

RMP-D8 and Dante Domain Manager (Firmware v2.00 and later)

The RMP-D8 indicates current Dante Domain enrollment status using its OLED display. To access this information, press the RMP-D8 front panel CONFIG button twice. If the RMP-D8 is *not* currently enrolled in any Dante Domain, it will indicate "NOT ENROLLED" in the Domain status window.

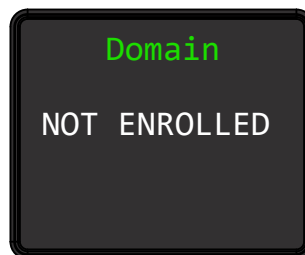

If the RMP-D8 is currently enrolled in a Dante Domain, the "NOT ENROLLED" message will turn off.

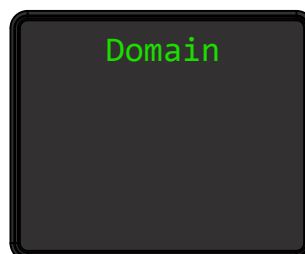

Changing the RMP-D8 Yamaha ID

Using the OLED display, navigate to the Yamaha ID edit menu screen by pressing the CONFIG button five times.

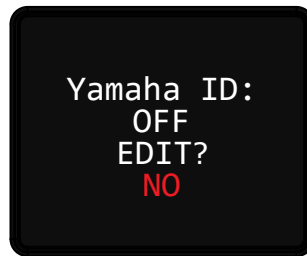

The RMP-D8 will prompt the user to EDIT the Yamaha ID. The default Yamaha ID is set to "OFF" and the EDIT prompt defaults to "NO." To EDIT the Yamaha ID number, rotate the ADJUST wheel one detent clock-wise until the EDIT prompt says "YES." Press the CONFIG button to accept the change.

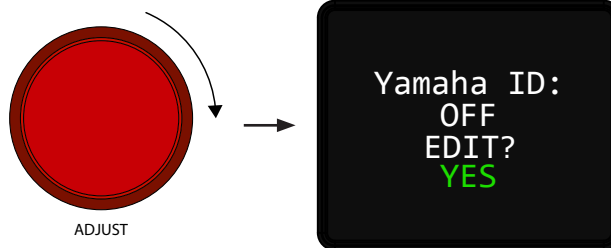

The RMP-D8 will then prompt the user to assign the Yamaha ID number. Rotate the ADJUST wheel to change the Yamaha ID number (in this example it was changed to ID 1). Press the CONFIG button to accept the Yamaha ID change.

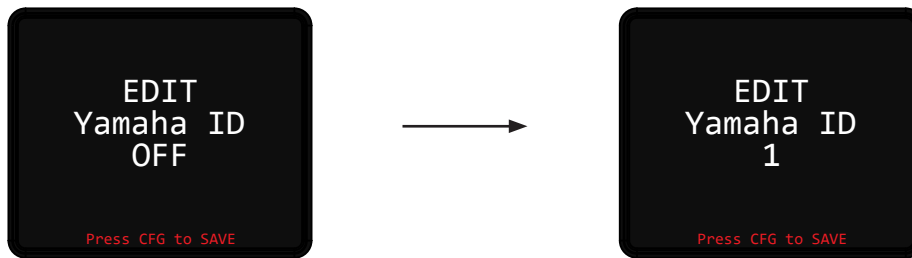

The RMP-D8 will then prompt the user to confirm the SAVE of the new Yamaha ID. Press the CONFIG button to save the Yamaha ID EDIT. The RMP-D8 will then show the new Yamaha ID prefix on the Dante ID menu screen. Press the CONFIG button once more to return to the main operational screen.

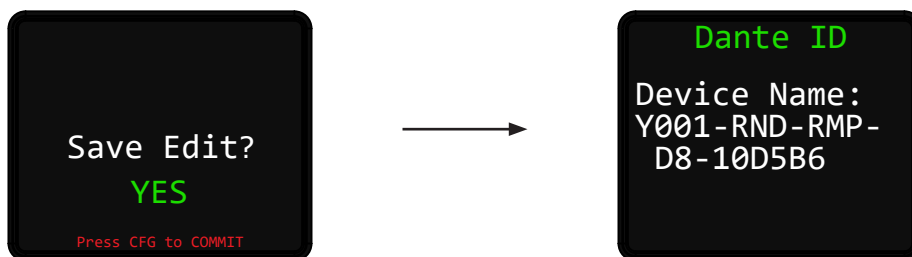

RMP-D8 USB Firmware Update

Field Update Procedure:

1. Power ON the RMP-D8 and press the CONFIG button *once* to take note of the current firmware (FW) version on the SYSTEM screen.
2. After confirming the current FW version, power the RMP-D8 OFF.
3. Plug a USB flash drive with the most recent "image.hex" file into the FIRMWARE UPDATE USB A port on the RMP-D8 rear panel.

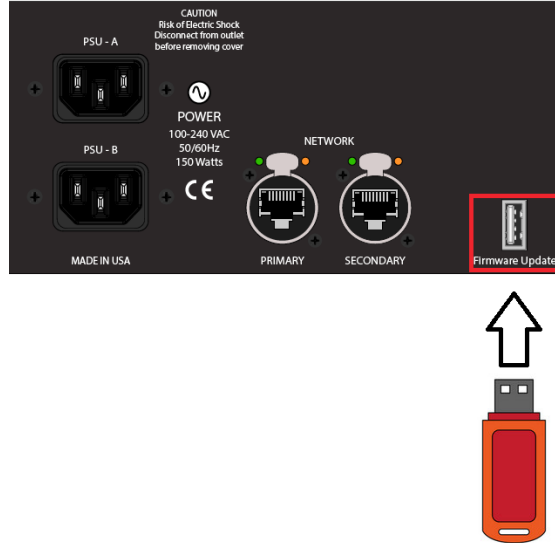

4. PRESS and HOLD Channel 1 and Channel 8 "Channel Select" buttons (STEP 1). While holding Channel 1 and 8 channel select buttons, power on the RMP-D8 (STEP 2).

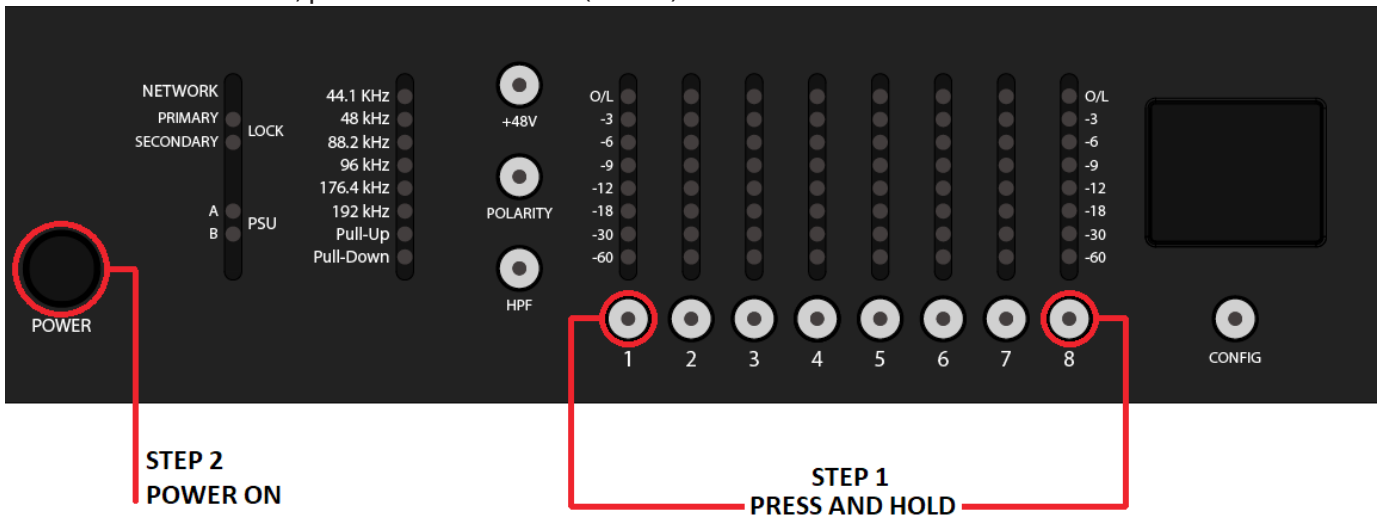

5. The RMP-D8 button LEDs will start to flash. At this point, release the Channel 1 and Channel 8 channel select buttons. The LEDs will stop flashing once the new application code has finished loading. The RMP-D8 will subsequently boot up in standard operating mode.
6. When the RMP-D8 has finished its standard boot sequence, turn the RMP-D8 OFF and remove the USB Flash Drive from the FIRMWARE UPDATE USB port.
7. Power the RMP-D8 ON again.
8. When the RMP-D8 has finished its boot sequence, press the CONFIG button once to verify that the new firmware version has been successfully updated.

RMP-D8 Specifications

Noise	150 Ohm Balanced Source, AES Output, 22 Hz to 22 kHz, un-weighted
+60dB Gain	-91 dBFS
Unity Gain	-110 dBFS
Frequency Response	0dBu , Unity Gain @ 96 kHz F _s
30 Hz to 45 kHz	+/- 0.2 dB Typical
10 Hz	-3 dB Typical
Input Impedance	5.5 kOhms
Gain	0 to 60 dB in 1 dB steps
High Pass Filter	-3dB @ 80 Hz, 12 dB/Octave Slope
Pad	-10 dB
Signal to Noise Ratio	84.4 dB
Dynamic Range	110 dB
Maximum Input Level	+25.5 dBu
System Latency @ 96kHz F _s	0.588 mS
Shipping Weight	17.6 lbs. (8 kg)
Shipping Dimensions	22" (W) x 18" (D) x 9" (H) 55.9 cm (W) x 45.7 cm (D) x 22.9 cm (H)
Power Cord Type	IEC Standard 3 Pin 18AWG Latching Type
Power Consumption	150W (Max)

PRODUCT WARRANTY

Rupert Neve Designs warrants this product to be free from defects in materials and workmanship for a period of one (1) year from date of purchase, and agrees to remedy any defect identified within such one year period by, at our option, repairing or replacing the product.

LIMITATIONS AND EXCLUSIONS

This warranty, and any other express or implied warranty, does not apply to any product which has been improperly installed, subjected to usage for which the product was not designed, misused or abused, damaged during shipping, damaged by any dry cell battery, or which has been altered or modified in any way. This warranty is extended to the original end user purchaser only. A purchase receipt or other satisfactory proof of date of original purchase is required before any warranty service will be performed. THIS EXPRESS, LIMITED WARRANTY IS IN LIEU OF ALL OTHER WARRANTIES, EXPRESS OR IMPLIED, TO THE EXTENT ALLOWED UNDER APPLICABLE STATE LAW. IN NO EVENT SHALL RUPERT NEVE DESIGNS BE LIABLE FOR ANY SPECIAL, INCIDENTAL, OR CONSEQUENTIAL DAMAGES RESULTING FROM THE USE OF THIS PRODUCT. Some states do not allow the exclusion or limitation of consequential damages or limitations on how long an implied warranty lasts, so this exclusion may not apply to you.

WARRANTY SERVICE

If you suspect a defect in this product, please call us at 512-847-3013 or email us at service@rupertneve.com to discuss the suggested defect (it is possible that a suspected defect could be due to improper usage) and to obtain a return authorization number. It shall be your responsibility to pay for shipping the product to us, and, if the product is determined to be defective, our responsibility to pay for shipping the product back to you.



Rupert Neve Designs

PO Box 1969

Wimberley TX 78676

www.rupertneve.com

tel: +1 512-847-3013

fax: +1 512-847-8869

775-00033 Rev A2