

EM 3731-II EM 3732-II EM 3732-II Command



Instruction manual

 **SENNHEISER**

Contents

Important safety instructions	2
The product family	5
The frequency bank system	6
Delivery includes	7
Product overview	8
Overview of the EM 3731-II/EM 3732-II/EM 3732 COM-II receivers	8
Overview of the displays	9
Reception display	10
Status display	11
Putting the receiver into operation	13
Fitting the device feet	13
Rack mounting	13
Connecting the antennas	14
Daisy chaining receivers	16
Connecting the receiver to the mains/disconnecting the receiver from the mains	16
Connecting the amplifier/mixing console	17
Connecting devices with AES3 digital input	17
Connecting an external word clock generator	17
Connecting the receivers to a PC via Ethernet	18
Using the receiver	19
Switching the receiver on/off	19
Connecting the headphones/adjusting the volume	19
Deactivating the lock mode	20
Synchronizing a transmitter with the receiver	20
Identifying receivers using the “Wireless Systems Manager” software (identifying function)	21
Sorting channels using the “Wireless Systems Manager” software	22
Using the operating menu	23
Overview of the operating menu	23
Working with the operating menu	24
Overview of the menus	25
Adjustment tips for the operating menu	29
Cleaning the receiver	40
Additional information	41
HiDyn plus™ (HDP) or HDX noise reduction	41
Squelch	41
Diversity reception	42
If a problem occurs	43
Accessories	44
Specifications	45
Manufacturer Declarations	47

Important safety instructions

1. Read these instructions.
2. Keep these instructions. Always include these instructions when passing the receiver on to third parties.
3. Heed all warnings.
4. Follow all instructions.
5. Do not use this apparatus near water.
6. Clean only with a dry cloth.
7. Do not block any ventilation openings. Install in accordance with the manufacturer's instructions.
8. Do not install near any heat sources such as radiators, heat registers, stoves, or other apparatus (including amplifiers) that produce heat.
9. Do not defeat the safety purpose of the polarized or grounding-type plug. A polarized plug has two blades with one wider than the other. A grounding type plug has two blades and a third grounding prong. The wide blade or the third prong are provided for your safety. If the provided plug does not fit into your outlet, consult an electrician for replacement of the obsolete outlet.
10. Protect the power cord from being walked on or pinched, particularly at plugs, convenience receptacles, and the point where they exit from the apparatus.
11. Only use attachments/accessories specified by the manufacturer.
12. Use only with the cart, stand, tripod, bracket, or table specified by the manufacturer, or sold with the apparatus. When a cart is used, use caution when moving the cart/apparatus combination to avoid injury from tip-over.
13. Unplug this apparatus during lightning storms or when unused for long periods of time.
14. Refer all servicing to qualified service personnel.
Servicing is required when the apparatus has been damaged in any way, such as power supply cord or plug is damaged, liquid has been spilled or objects have fallen into the apparatus, when the apparatus has been exposed to rain or moisture, does not operate normally, or has been dropped.
15. To completely disconnect this apparatus from the AC mains, disconnect the power supply cord plug from the AC receptacle.
16. **WARNING:** To reduce the risk of fire or electric shock, do not expose this apparatus to rain or moisture.
17. Do not expose this equipment to dripping or splashing and ensure that no objects filled with liquids, such as vases, are placed on the equipment.
18. The mains plug of the power supply cord shall remain readily accessible.





Hazard warnings on the rear of the receiver

The label shown on the left is attached to the rear of the receiver. The symbols on this label have the following meaning:

This symbol is intended to alert the user to the presence of uninsulated dangerous voltage within the receiver's enclosure that may be of sufficient magnitude to constitute risk of fire or electric shock.

This symbol is intended to alert the user to the risk of electric shock if the receiver is opened. There are no user serviceable parts inside. Refer servicing to qualified personnel only.

This symbol indicates the presence of important operating and maintenance instructions in the literature accompanying this receiver.

Overloading

Do not overload wall outlets and extension cords as this may result in fire and electric shock.

Danger of hearing damage due to high volumes

This is a professional receiver. Commercial use is subject to the rules and regulations of the trade association responsible. Sennheiser, as the manufacturer, is therefore obliged to expressly point out possible health risks arising from use.

This receiver is capable of producing sound pressure exceeding 85 dB(A). 85 dB(A) is the sound pressure corresponding to the maximum permissible volume which is by law (in some countries) allowed to affect your hearing for the duration of a working day. It is used as a basis according to the specifications of industrial medicine. Higher volumes or longer durations can damage your hearing. At higher volumes, the duration must be shortened in order to prevent hearing damage. The following are sure signs that you have been subjected to excessive noise for too long a time:

- You can hear ringing or whistling sounds in your ears.
- You have the impression (even for a short time only) that you can no longer hear high notes.

Intended use of the receiver

Intended use of the EM 3731-II single receiver or the EM 3732-II and EM 3732 COM-II twin receivers includes:

- having read these instructions, especially the chapter “Important safety instructions” on page 2,
- using the receiver within the operating conditions and limitations described in this instruction manual.

“Improper use” means using the receiver other than as described in these instructions, or under operating conditions which differ from those described herein.

The product family

The receivers of the product family ensure highest reception reliability and offer unmatched ease of use. Due to their large switching bandwidth and numerous connection options, these receivers provide maximum flexibility in daily operation.

The product family is comprised of the following models:

- EM 3732 COM-II twin receiver
- EM 3732-II twin receiver
- EM 3731-II single receiver

All receivers of the product family have the following features:

- Up to 184 MHz switching bandwidth
- Scan function
- Frequencies tuneable in steps of 5 kHz
- True diversity reception
- Integrated antenna splitter for daisy chaining up to eight receivers
- DSP-based audio expander, HiDyn plus™(HDP) and HDX
- AES3 digital audio output
- External word clock synchronization of the digital audio output
- Audio output level can be set in steps of 1 dB
- Transformer balanced audio outputs
- Command audio output (EM 3732 COM-II receiver only)
- Ethernet socket for connection to a PC
- Receivers can be monitored and remote controlled using the supplied Sennheiser WSM PC software
- Operation via jog dial
- Hot keys for storing, synchronization, headphone selection and escape function
- Intuitive, icon-based operating menu
- Display with high contrast and intensity
- LEDs for indicating warning states
- Infra-red synchronization of receiver settings with suitable transmitters
- Both receivers of a twin receiver can be monitored – individually or simultaneously – via headphones

The frequency bank system

The receivers are available in four UHF frequency ranges with up to 184 MHz switching bandwidth:

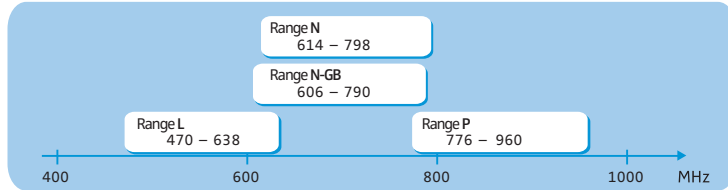

The receivers have seven frequency banks:

Channel	Frequency bank						
	1	2	3	4	5	6	U
1	The receiving frequencies are factory-preset (see enclosed frequency table) and cannot be changed.						The receiving frequencies can be freely selected within the switching bandwidth.
2							
...							
max. 60	Optimized for maximum transmission reliability						
	<p>Additionally available channels in Low Intermodulation mode</p>						

CAUTION! Risk of reception interference!

If – within the receiver’s frequency range – transmitters transmit on channels from different frequency banks, reception can be subject to interference and intermodulation. Only the factory-preset frequencies within the frequency banks “1” to “6” are interference and intermodulation free.

- ▶ Set all transmitters of a multi-channel system to different channels within the same frequency bank.

Distribution of the receiving frequencies within the frequency banks 1 to 6:

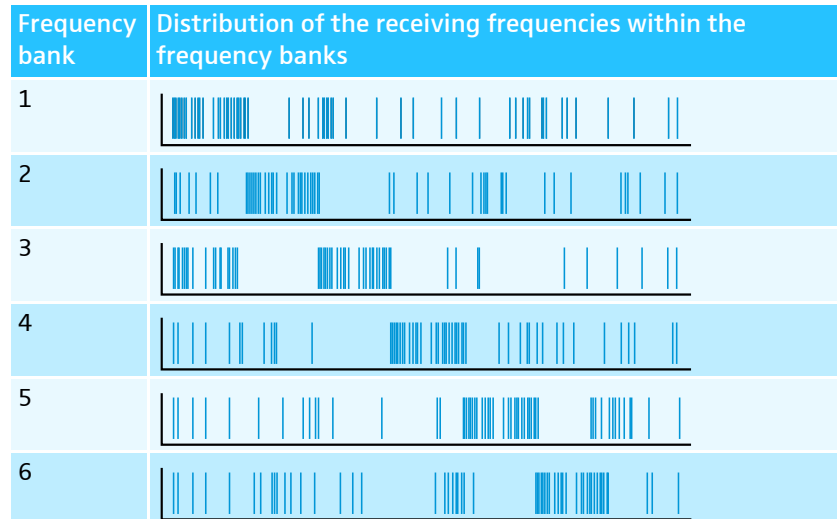

The varying accumulation of frequencies within the frequency banks allows you to use as many channels as possible in a crowded frequency band.

Delivery includes

- 1 EM 3732 COM-II twin receiver or
- 1 EM 3732-II twin receiver or
- 1 EM 3731-II single receiver
- 3 mains cables (with EU, UK and US plug)
- 2 BNC antenna daisy chain cables (50 Ω)
- 1 BNC word clock daisy chain cable (75 Ω)
- 4 device feet
- 1 RJ 45 Ethernet cable
- 2 antennas
- 1 instruction manual
- 1 CD ROM with:
 - the “Wireless Systems Manager” (WSM) software
 - the instruction manual of the “Wireless Systems Manager” software
- 1 Frequency table

Product overview

Overview of the EM 3731-II/EM 3732-II/EM 3732 COM-II receivers

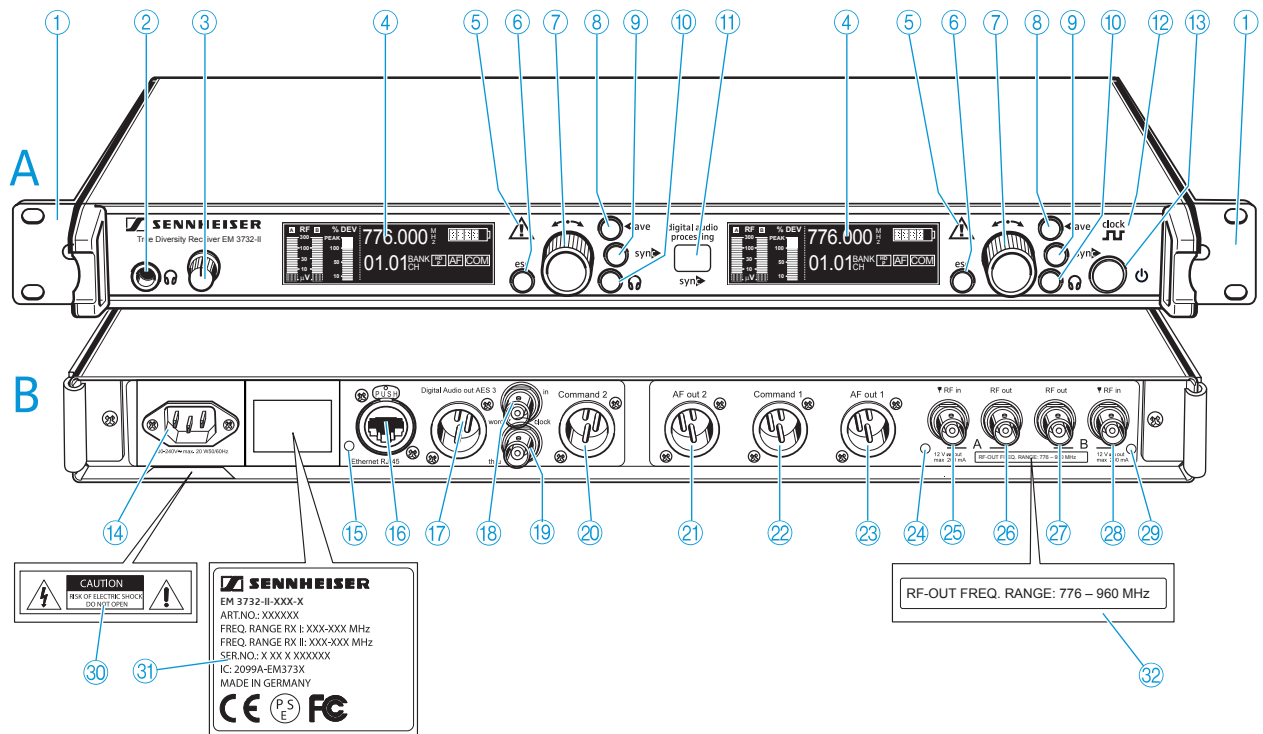

A Front panel

- ① Rack mount "ears"
- ② 1/4" (6.3 mm) jack socket for headphones
- ③ Headphone volume control
- ④ Display (see next page)
- ⑤ Warning triangle for indicating error states
- ⑥ esc button, backlit
- ⑦ Jog dial
- ⑧ save button, backlit
- ⑨ sync button, backlit
- ⑩ Headphone button, backlit (except EM 3731-II single receiver)
- ⑪ Infra-red interface
- ⑫ Display for external word clock synchronization
- ⑬ ⏻ button, backlit

B Rear panel

- ⑭ 3-pin mains socket
- ⑮ LED for LAN data transmission
- ⑯ RJ 45 socket for LAN connection
- ⑰ XLR-3 socket (male) for digital audio output, digital balanced, AES3
- ⑱ BNC socket for word clock input (75 Ω)

- ⑲ BNC socket for word clock daisy chain output (75 Ω)
- ⑳ XLR-3 socket (male) for Command output 2*, balanced (EM 3732 COM-II twin receiver only)
- ㉑ XLR-3 socket (male) for audio output AF Out 2*, balanced (except EM 3731-II single receiver)
- ㉒ XLR-3 socket (male) for Command output 1*, balanced (except EM 3731-II single receiver)
- ㉓ XLR-3 socket (male) for audio output AF Out 1*, balanced
- ㉔ LED for booster supply of antenna input A
- ㉕ BNC socket, antenna input A (ANT A – RF in, DC out, 50 Ω)
- ㉖ BNC socket, daisy chain output A (ANT A – RF out)
- ㉗ BNC socket, daisy chain output B (ANT B – RF out)
- ㉘ BNC socket, antenna input B (ANT B – RF in, DC out, 50 Ω)
- ㉙ LED for booster supply of antenna input B
- ⑳ Label with hazard warnings
- ㉑ Type plate
- ㉒ Label with frequency range for daisy chaining

* The audio outputs marked with the number "1" output the audio signal of the left receiver of the twin receiver (as viewed from the front); the audio outputs marked with the number "2" output the audio signal of the right receiver.

Overview of the displays

After switch-on, the receiver displays the “Bank/Channel” status display. For further illustrations and examples of the different status displays, refer to page 38.

Each display provides information on the operating states of the receiver and those of the received transmitter.

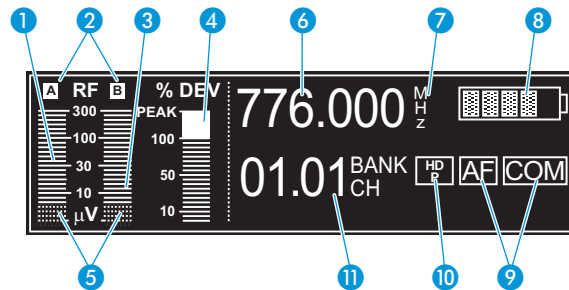

Reception display

- 1 RF level display “RF” for antenna A
- 2 Diversity display (antenna A or antenna B active)
- 3 RF level display “RF” for antenna B
- 4 Audio level display “DEV”
- 5 Display for the squelch threshold



For additional information, refer to page 10.

Status display

- 6 Frequency display
- 7 “MHz” – appears when the frequency is displayed
- 8 6-step transmitter battery status display
- 9 Command display (status display for the audio outputs AF and Command)
(EM 3732 COM-II twin receiver only)
- 10 Display for the compander system
- 11 Display for the current frequency bank and channel or the name



For additional information, refer to page 11.

Brightness control

The display has an automatic brightness control. The brightness is dimmed after the last button press. With each new button press, the display lights up with full brightness.

Triggers for dimming	after	Behavior of the display
No operation	60 s	Display is slightly dimmed
Squelch not reached	20 min	Display goes off

Reception display

The reception display is permanently displayed. If you do not press a button on the receiver, the display will dim after 60 seconds (see page 9).

RF level display "RF" for the antennas

The left bargraph ① shows the strength of the received RF signal for antenna A; the right bargraph ③ shows the strength of the received RF signal for antenna B.

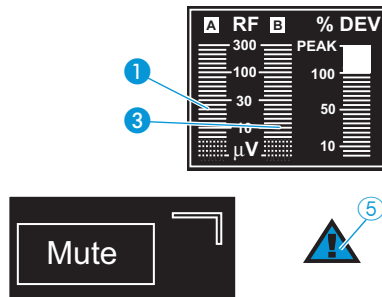

When the RF signal of the received transmitter is too weak on both antennas:

- the text "Mute" flashes several times in alternation with the status display,
- the warning triangle for indicating error states ⑤ lights up red,
- the receiver is automatically muted to suppress hissing noise.

Display for the squelch threshold

The top edge of the rastered area ⑤ shows the adjusted squelch threshold. The squelch threshold can be adjusted via the operating menu (see "Adjusting the squelch threshold" on page 31).

If the squelch threshold is not reached for 20 minutes, the display goes off (see page 9).

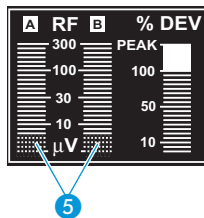

Diversity display

The receivers operate on the true diversity principle (see "Diversity reception" on page 42). The diversity display ② indicates whether diversity section A (i.e. antenna A) or diversity section B (i.e. antenna B) is active. The letter of the active diversity section appears backlit.

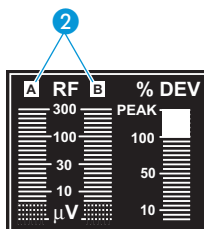

Audio level display "DEV"

The audio level display "DEV" ④ shows the modulation of the received transmitter.

When the transmitter's audio input level is excessively high, the receiver's audio level display "DEV" ④ shows more than 100%.

When the transmitter is overmodulated frequently or for an extended period of time, the text "AF Peak" appears and the warning triangle for indicating error states ⑤ lights up red.

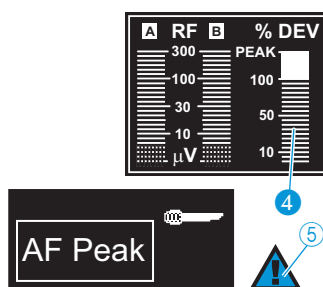

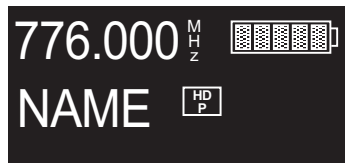

Status display

The status display shows the receiving frequency, the transmitter battery status and – depending on the selection made in the “Display” menu – either the frequency bank and the channel number or the name of the receiver. With the EM 3732 COM-II receiver, the command display can also be displayed within the status display. The contents of the status display can be changed in the “Display” menu (see page 38).

When pressing the jog dial ⑦, the status display is replaced by the operating menu (see “Working with the operating menu” on page 24).

When in the operating menu, you can return to the status display by pressing the **esc** button ⑥ one or several times.

Frequency display



The frequency display ⑥ shows the current receiving frequency in MHz.

Display for the current frequency bank and channel or the name



The display for the current frequency bank and channel or the name ⑪ shows – depending on the selection made in the “Display” menu – the following:

- Frequency bank “1...6, U” and channel number “1...60”
- Name

Transmitter battery status display



The 6-step transmitter battery status display ⑧ provides information on the charge status of the transmitter’s battery/accupack:

Number of segments	Charge status	
	Accupack	Battery
	approx. 100 %	full
	approx. 80 %	-
	approx. 60 %	half-full
	approx. 40 %	-
	approx. 20 %	-
(Low Batt)	approx. 0 %	almost empty

If no battery/accupack status signal is received, the battery status display is not shown.



When the battery/accupack is almost empty, text “Low Batt” flashes in alternation with the status display. In addition, the warning triangle for indicating error states ⑤ lights up red.

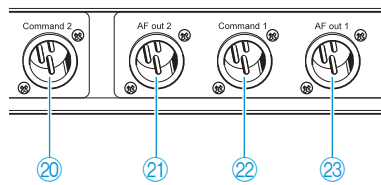

Command display (status display of the audio outputs AF and Command)

The command display is only available with the EM 3732 COM-II twin receiver.

Besides the two audio outputs 21 and 23 the EM 3732 COM-II twin receiver also features the two command outputs 20 and 22.

Via the "Command" menu, you can configure the receiver so that – with the command button of the transmitter pressed – the audio signal is available at only one of the outputs or at both (see "Configuring the audio outputs of the EM 3732 COM-II" on page 33).

The command display 9 shows the audio output at which the transmitter's audio signal is available.



When "AF" lights up brightly, the audio signal is available at the audio output 21 and/or 23.



When "AF" does not appear, the audio signal is **not** issued on the audio output 21 and/or 23.



When "COM" lights up brightly, the audio signal is available at the command output 20 and/or 22.



When "COM" does not appear, the audio signal is **not** issued on the command output 20 and/or 22.



Depending on the selected compander system, either "HDP" for HiDyn plus™ or "HDX" is shown on the display.

Display for the compander system

LEDs for booster supply of antenna inputs

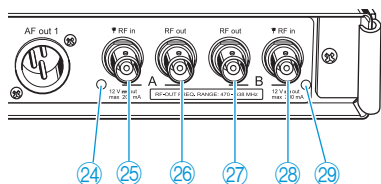

The LEDs for booster supply of antenna input A 24 and/or B 29 **light up** when:

- the booster supply voltage is applied to the corresponding antenna input A 25 and/or B 28.

The LEDs for booster supply of antenna input A 24 and/or B 29 **go off** when:

- the booster supply voltage for the corresponding antenna input A 25 and/or B 28 is switched off or
- the booster supply voltage is short-circuited or overloaded.

Putting the receiver into operation

Fitting the device feet

To ensure that the receiver cannot slip on the surface on which it is placed, four self-adhesive soft rubber feet are supplied.



Do not fit the device feet when rack mounting the receiver.

CAUTION! Risk of staining of furniture surfaces!

Some furniture surfaces have been treated with varnish, polish or synthetics which might cause stains when they come into contact with other synthetics. Despite a thorough testing of the synthetics used by us, we cannot rule out the possibility of staining.

- ▶ Do not place the receiver on delicate surfaces.

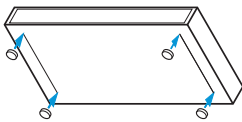

- ▶ Ensure that the base of the receiver is clean and free from grease before fitting the device feet.
- ▶ Fit the device feet to the four corners of the receiver as shown.

Rack mounting

CAUTION! Risks when rack mounting the receiver!



When installing the receiver in a closed or multi-rack assembly, please consider that, during operation, the ambient temperature, the mechanical loading and the electrical potentials will be different from those of devices which are not mounted into a rack.

- ▶ The ambient temperature within the rack must not exceed the temperature limit specified in the specifications.
 - ▶ When installing the receiver in a rack, take good care not to affect the ventilation required for safe operation or provide additional ventilation.
 - ▶ Make sure the mechanical loading of the rack is even to avoid a hazardous condition such as a severely unbalanced rack.
 - ▶ When connecting the receiver to the power supply, observe the information indicated on the type plate. Avoid circuit overloading. If necessary, provide overcurrent protection.
 - ▶ Ensure a reliable mains ground connection of the device by taking appropriate measures – especially when you are using an extension cable or a multi-outlet power strip.
 - ▶ When installing the receiver in a closed or multi-rack assembly, please note that intrinsically harmless leakage currents of the individual devices may accumulate, thereby exceeding the allowable limit value. As a remedy, ground the rack via an additional ground connection.
-

The rack mount "ears" are already fitted to the receiver on delivery. To mount the receiver into a 19" rack:

- ▶ Slide the receiver into the 19" rack.
- ▶ Secure the rack mount "ears" ① to the rack using four screws (not included in the delivery).

Connecting the antennas

CAUTION! Danger of short-circuit due to uninsulated antennas!



If you switch the booster supply voltage on, a 12 V DC voltage is applied to the antennas – **even when you switch the receiver off!** If uninsulated antennas come into contact with objects which conduct electricity, this voltage can produce sparking and audio interference.

- ▶ Use insulated antennas.
- OR
- ▶ Always mount uninsulated antennas so that they cannot come into contact with objects which conduct electricity.

The two antenna inputs ②⑤ and ②⑧ allow you to connect either:

- the two supplied antennas to the rear of the receiver (see next section) or
- the two supplied antennas to the front of the receiver (see "Mounting the antennas to the front of the rack" on page 14) or
- two remote antennas to the rear of the receiver (see "Connecting and positioning remote antennas" on page 15).

In addition, the receiver has two daisy chain outputs ②⑥ and ②⑦ for supplying the antenna signals to further receivers (see "Daisy chaining receivers" on page 16).

Connecting the antennas to the rear of the receiver

The supplied antennas can be mounted quickly and easily and are suitable for all applications where – good reception conditions provided – a wireless transmission system is to be used without a large amount of installation work.

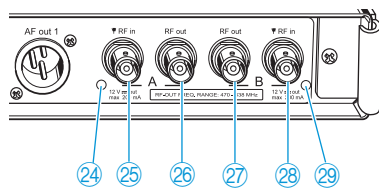

- ▶ Connect the antennas to the BNC sockets ②⑤ and ②⑧ at the rear of the receiver.
- ▶ Align the antennas upwards in a V-shape.

Mounting the antennas to the front of the rack

To mount the antenna connections to the front of the rack when rack mounting the receiver, you require the GA 3030 AM antenna front mount kit (optional accessory). The GA 3030 AM consists of:

- 2 BNC extension cables (screw-in BNC socket ③③ to BNC connector ③⑦),
- 2 antenna holders ③⑥,
- 4 screws,
- 2 washers ③⑤,
- 2 nuts ③④.

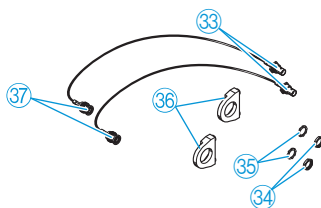

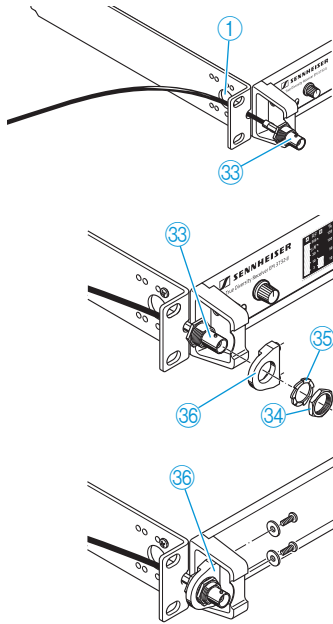

- ▶ Unsecure the rack mount "ears" ① from the rack.
- ▶ Guide the BNC cables through the holes in the rack mount "ears" as shown in the diagram on the left.
- ▶ Screw the antenna holders ③⑥ to the BNC sockets ③③ using the supplied washers ③⑤ and nuts ③④.
- ▶ Secure the antenna holders ③⑥ to the handles of the receiver using two of the supplied screws respectively.

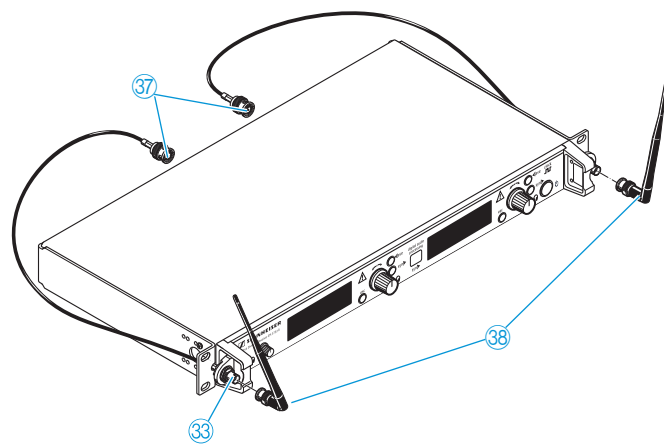

- ▶ Connect the two BNC connectors ③⑦ to the BNC sockets ②⑤ and ②⑧ at the rear of the receiver.
- ▶ Slide the receiver into the 19" rack.
- ▶ Resecure the rack mount "ears" ① to the rack.
- ▶ Connect the antennas ③⑧ to the BNC sockets ③③.
- ▶ Align the antennas upwards in a V-shape.

Connecting and positioning remote antennas

Use remote antennas when the position of the receiver is not the best antenna position for optimum reception. Remote antennas are available as accessories.

- ▶ Connect the remote antennas to the BNC sockets ②⑤ and ②⑧ using a low-attenuation 50-Ω coaxial cable.



Ready-made coaxial antenna cables from Sennheiser are available as accessories with length of 1 m, 5 m and 10 m (see "Accessories" on page 44).

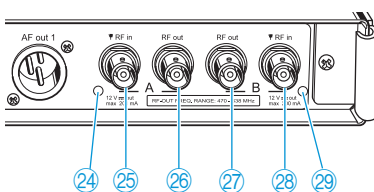

- ▶ If you connect active antennas (e.g. A 3700, AD 3700) or antenna boosters (e.g. AB 3700), switch on the DC supply voltage for external active antennas and antenna boosters (see page 31) so that the LEDs ②④ and/or ②⑨ light up; if you do not connect active antennas or antenna boosters, switch off the booster supply voltage so that the LEDs ②④ and/or ②⑨ do not light up.

i If the booster supply voltage is switched on (see page 31), it remains switched on even when the receiver is switched off.

- ▶ Position antennas in the same room in which the transmission takes place! Maintain a minimum distance of 1 m between antennas and a minimum distance of 50 cm between antennas and metal objects (including reinforced concrete walls).

Daisy chaining receivers

The receivers feature an integrated antenna splitter so that up to eight receivers can be daisy chained using the supplied short antenna daisy chain cables. The type plate 31 indicates the daisy chained frequency range.

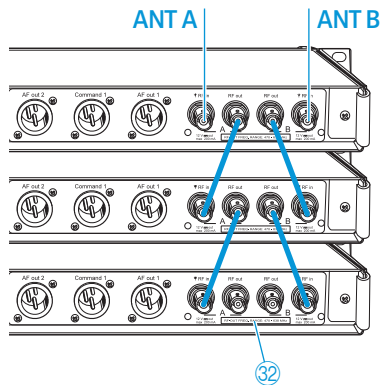

- ▶ Connect the two supplied antennas or two remote antennas (available as accessories) to the BNC sockets 25 and 28 at the rear of the first receiver.
- ▶ Use the supplied 50-Ω antenna daisy chain cables to daisy chain the receivers as shown in the diagram on the left.

i The antenna signals are also daisy chained when a receiver is switched off. If the booster supply voltage is switched on (see page 31), it remains switched on even when the receiver is switched off.

Connecting the receiver to the mains/ disconnecting the receiver from the mains

CAUTION! Damage to the device due to electric current!



If you connect the receiver to an unsuitable power supply, this can cause damage to the device.

- ▶ Use the supplied mains cable to connect the receiver to the mains (100 to 240 V AC, 50 or 60 Hz).
- ▶ Ensure a reliable mains ground connection of the receiver – especially when you are using multi-outlet power strips or extension cables.

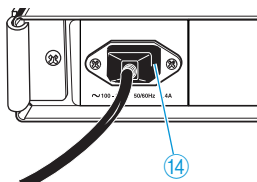

The receiver has no mains switch. To connect the receiver to the mains:

- ▶ Connect the supplied mains cable to the 3-pin mains socket 14.
- ▶ Plug the mains connector into the wall socket.

To disconnect the receiver from the mains:

- ▶ Pull out the mains connector from the wall socket. All daisy chained signals are interrupted, i.e.:
 - the antenna signals at the daisy chain outputs 27 and 26,
 - the booster supply voltage,
 - the signal of the external word clock generator.

Connecting the amplifier/mixing console

The receiver has transformer balanced audio outputs.

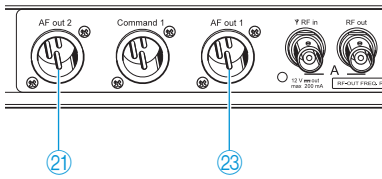

- ▶ Connect the amplifier/mixing console to the XLR-3 socket AF Out 1 (23) (left receiver) or to the XLR-3 socket AF Out 2 (21) (right receiver).
- ▶ Via the operating menu of the corresponding receiver, adjust the level of the audio output to the input of the amplifier or mixing console (see "Adjusting the audio output level" on page 32).

Connecting devices with AES3 digital input

The digital balanced XLR-3M audio output (17) outputs the signals of both receivers in AES3 format.

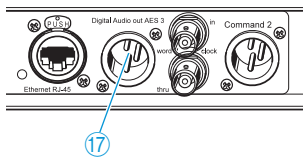

- ▶ Use a special double-shielded 110 Ω AES3 cable to connect the device with AES3 digital input to the digital balanced XLR-3M audio output (17). This prevents that the digital data transmission interferes with RF reception.



A ready-made AES3 cable from Sennheiser is available as an accessory with a length of 10 m (see "Accessories" on page 44).

- ▶ Via the "Clock" menu, select the desired sampling rate (see "Selecting the sampling rate for digitalization" on page 32).

Connecting an external word clock generator

The receiver can digitalize the audio signal and output it via the digital balanced XLR-3M audio output (17). The built-in A/D converter supports sampling rates of 44.1 kHz, 48 kHz, 88.2 kHz and 96 kHz.

If you want to connect an external word clock generator instead, proceed as follows:

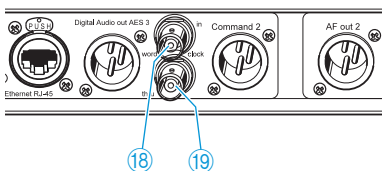

- ▶ Use a shielded 75 Ω coaxial BNC cable to connect the external word clock generator to the BNC socket (18).
- ▶ From the "Clock" menu, select "Ext." (see "Selecting the sampling rate for digitalization" on page 32).

The display for external word clock synchronization (12):

- lights up permanently when the digital audio output of the receiver is synchronized with the external word clock generator,
- flashes when "Ext." is selected in the "Clock" menu but no external word clock generator is connected,
- flashes when the signal of the external word clock generator is available but has not synchronized the digital audio output of the receiver,
- is off when the receiver's internal word clock generator is used.



- Both receivers of a twin receiver use the same word clock signal.
- The receiver has a BNC socket for word clock daisy chain output (19) for supplying the word clock signal to further daisy chained receivers using the supplied BNC word clock daisy chain cable. The word clock signal is also daisy chained when a receiver is switched off.

Connecting the receivers to a PC via Ethernet

The receivers can be centrally configured and monitored via a PC and the supplied "Wireless Systems Manager" software. Additionally, you can update the firmware in the receivers.



If you want to connect several receivers to the same Ethernet socket of your network, you require a standard 100Base-T Ethernet switch.

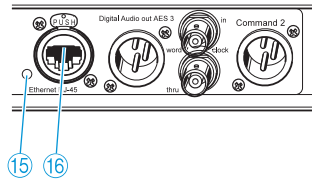

- ▶ Connect the supplied RJ 45 Ethernet cable to the RJ 45 socket for LAN connection 16 and to your switch or network.
- ▶ Install the "Wireless Systems Manager" software on your PC.
- ▶ Continue as described in the instruction manual of the "Wireless Systems Manager" software.
The LED for LAN data transmission 15 lights up when data is transmitted.



When you are working with the "Wireless Systems Manager" software, you can use the "Spectrum Analyzer" tool to perform a continuous frequency scan. The "Spectrum Analyzer" tool uses the receiver that you select to check the relevant frequency range for signals and records the corresponding measured values. For detailed information, please refer to the chapter "The 'RF Spectrum Analyzer' tool" of the "Wireless Systems Manager" manual.



When selecting this receiver in the "Spectrum Analyzer", please note that during the frequency scan:

- you **cannot** use the selected receiver for its normal purpose,
- the text "**Scanning**" is displayed and
- the receiver is automatically muted.

Using the receiver

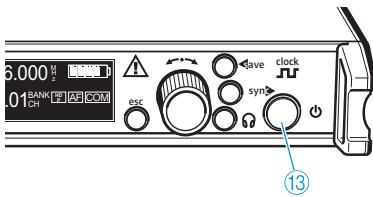
Switching the receiver on/off



The EM 3731-II single receiver is switched on and off with the  button (13). The two receivers of the EM 3732-II or EM 3732 COM-II twin receiver are switched on and off together with the  button (13). The  button (13) is not a mains switch.



If you only want to use one of the two receivers of the EM 3732-II or EM 3732 COM-II, you can set the second receiver to standby mode (see “Setting a receiver to standby mode” on page 39).

To switch the receiver on:

- ▶ Press the  button (13).

The display shows the product name (e.g. EM 3731-II) and the serial number of the current firmware (behind “Software”). The status display appears after several seconds.

To switch the receiver off:

- ▶ Press the  button (13) for approx 2 seconds until the display goes off. The receiver is switched off but daisy chained signals continue to be output. This means that:
 - the daisy chain outputs (27) and (26) output the antenna signals.
 - if the booster supply voltage is switched on (see page 31), it remains switched on even when the receiver is switched off,
 - the signal of the external word clock generator is looped through to the word clock daisy chain output (19).

Connecting the headphones/adjusting the volume

CAUTION! Danger of hearing damage!



Listening at high volume levels for long periods can lead to permanent hearing defects.

- ▶ Set the volume for the connected headphones to the minimum before putting the headphones on.

The EM 3731-II single receiver features a headphone socket (2). The two receivers of the EM 3732-II or EM 3732 COM-II twin receiver have a common headphone socket (2). This common headphone socket (2) allows you to either monitor the audio signal of one receiver or to simultaneously monitor the audio signals of both receivers.

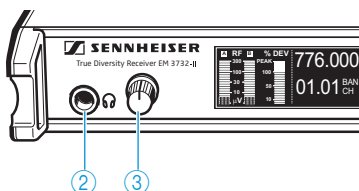

- ▶ Set the headphone volume control (3) to the lowest volume by turning it to the left as far as possible.
- ▶ Connect headphones with a 1/4" (6.3 mm) stereo jack plug to the headphone socket (2).

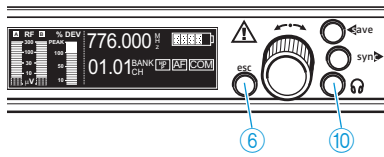

To monitor the audio signal of one of the two receivers of a twin receiver:

- ▶ Press the headphone button ⑩ of the receiver whose audio signal you want to monitor.

To simultaneously monitor the audio signals of both receivers of a twin receiver:

- ▶ Simultaneously press the headphone buttons ⑩ of both receivers. The audio signal of the left receiver is output via the left headphone channel, the audio signal of the right receiver is output via the right headphone channel.
- ▶ Gradually increase the volume.

To switch the headphone output off:

- ▶ Press the headphone button ⑩ of the receiver whose headphone output you want to switch off.

Deactivating the lock mode

When the receivers are remote controlled via a PC and the “Wireless Systems Manager” software, their buttons can be locked via the “Wireless Systems Manager” software. To deactivate the lock mode:



- ▶ Press the **esc** button ⑥ until the progress bar is complete and the status display appears. The lock mode is deactivated and the settings can be made manually.

Synchronizing a transmitter with the receiver

Via its infra-red interface, the receiver can transfer the frequency and the name to suitable transmitters (e.g. SK 5212-II, SKM 5200-II, SK 5212, SKM 5200 or SKP 3000).

- i** The transmitter must be from a compatible frequency range and be equipped with the same compander system (HDP, see page 41) as the receiver. With transmitters that are equipped with HDX (e.g. 2000 series and es G3), synchronization via the infra-red interface or a firmware update is not possible.

- ▶ Make sure that the HDP compander system is activated on your receiver (siehe “Selecting the compander system” on page 37).
- ▶ Set the receiver to the desired receiving frequency (see page 29) and enter the desired name (see page 30).
- ▶ Press the **sync** button ⑨ on your receiver. The two blue LEDs in the infra-red interface (sync) ⑪ flash and the backlighting of the **sync** button ⑨ flashes red. The receiver is ready for synchronization.

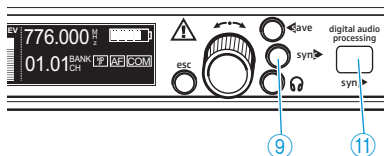

- i** The **sync** button ⑨ can also be used for the sorting function of the “Wireless Systems Manager” software. For more information, refer to page 22.

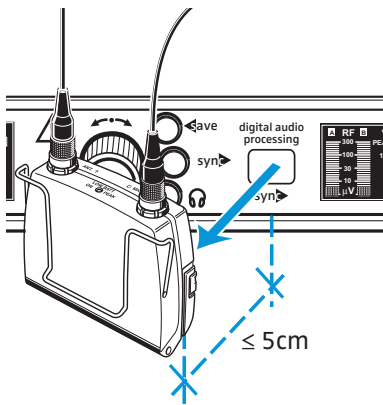

- ▶ Position the transmitter's infra-red interface at a max. distance of 5 cm in front of the infra-red interface (sync) ⑪. The transfer starts automatically. During the transfer, the two blue LEDs in the infra-red interface (sync) ⑪ flash and the backlighting of the sync button ⑨ flashes green.

- After successful completion of the synchronization, the two blue LEDs in the infra-red interface (sync) ⑪ stop flashing and the sync button ⑨ is backlit in green. The receiver's frequency and name are now also set on the transmitter and the transmission link is ready for operation.
- If an error occurred during synchronization (e.g. the transmitter is too far away from the receiver), the two blue LEDs in the infra-red interface (sync) ⑪ stop flashing and the sync button ⑨ is backlit in red.



- ▶ **i** The infra-red interface of the SKM 5200-II hand-held transmitter is located at the left-hand margin of the display. Position the transmitter's infra-red interface precisely in front of the receiver's infra-red interface (sync) ⑪.

Identifying receivers using the “Wireless Systems Manager” software (identifying function)

In multi-channel operation, it can be useful to identify the individual channels of the receivers via the “Wireless Systems Manager” software. The identifying function shows you which channel is assigned to which receiver.

- ▶ Start the identifying function as described in the instruction manual of the “Wireless Systems Manager” software. “Identified” appears on the status display of the identified receiver:



After 60 seconds, the text disappears and the current status display is shown again.

To change to the current status display before the end of the 60 seconds:

- ▶ Press the esc button ⑥.

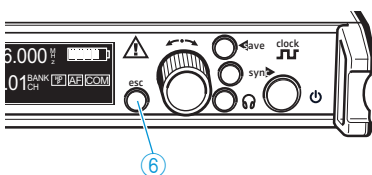



Sorting channels using the “Wireless Systems Manager” software

The sorting function of the “Wireless Systems Manager” software allows you change the channel assignment of the receivers at any time and to save this new channel assignment in a scene.

- ▶ Start the sorting function as described in the instruction manual of the “Wireless Systems Manager” software.
- ▶ Press and hold the **sync** button  of the receiver to which you want to assign channel 1 for at least 1.5 seconds. The “Wireless Systems Manager” software assigns the receiver the channel 1 and displays this receiver first in the new scene. “Sorted” appears on the status display of the receiver:



 The **sync** button  can also be used for synchronizing transmitters with receivers. For more information, refer to page 20.

When carrying out the sorting function, the synchronization is deactivated.

- ▶ Repeat the above steps for the remaining receivers. Each additional receiver whose **sync** button  you press and hold for at least 1.5 seconds is assigned the next higher channel. “Sorted” appears on the status displays of the corresponding receivers. The receivers are displayed in the subsequent positions in the scene of the “Wireless Systems Manager” software.

 The text “Sorted” automatically goes off after 1 second.

After you have sorted your receivers, you can assign this sort sequence to an already existing scene in the “Wireless Systems Manager” software or you can create a new scene. For more information, please refer to the instruction manual of the “Wireless Systems Manager” software.

 Already sorted channels cannot be sorted again. If you try to change the sort sequence, “Already Sorted” appears on the status display.



- ▶ If necessary, start a new sorting procedure using the “Wireless Systems Manager” software.

Using the operating menu

Overview of the operating menu

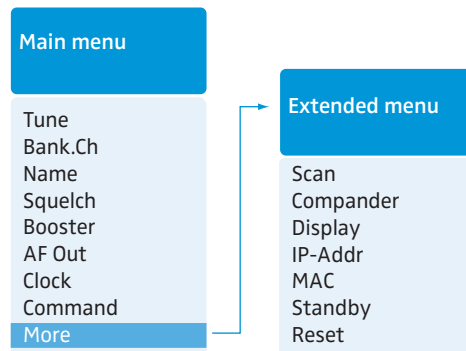

Display	Function of the menu
Main menu	
"Tune"	Sets a receiving frequency (this frequency is automatically stored in channel "01" of the frequency bank "U" (user bank))
"Bank.Ch"	Switches between the frequency banks and between the channels of a frequency bank
"Name"	Enters a name
"Squelch"	Adjusts the squelch threshold
"Booster"	Switches the booster supply voltage on/off
"AF Out"	Adjusts the audio output level
"Clock"	Adjusts the sampling rate of the digital audio output
"Command"	(EM 3732 COM-II receiver only) Configures the audio and command outputs
"More"	Changes to the extended menu
Extended menu	
"Scan"	Scans the frequency banks for free frequencies
"Compander"	Selects the compander system
"Display"	Selects the status display
"IP-Addr"	Adjusts the IP address of the receiver
"MAC"	Displays the MAC address
"Standby"	Sets the receiver to standby mode
"Reset"	Loads the factory-preset default settings

Working with the operating menu

By way of example of the “Tune” menu, this section describes how to use the operating menu.



After switching the receiver on, the status display is shown on the display panel.

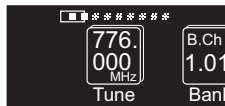

Getting into the operating menu

- ▶ Press the jog dial ⑦.
The status display is replaced by the operating menu. The “Tune” menu is displayed together with its current setting. The position of a menu within the operating menu is illustrated by a graphic in the upper display margin (the “Tune” menu is on the very left of the operating menu).

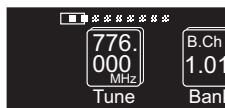

Selecting a menu

- ▶ Turn the jog dial ⑦ until the icon of the desired menu is in the center of the display.
- ▶ Press the jog dial ⑦ to get into the setting mode of the selected menu. The icon of the menu is displayed and the current setting starts flashing. In addition, the green backlighting of the save button ⑧ flashes.



Adjusting a setting

- ▶ Turn the jog dial ⑦ until the desired setting appears.
- ▶ Press the jog dial ⑦ to confirm the selected setting. Depending on the selected menu, the next setting that can be changed and confirmed by turning and pressing the jog dial ⑦ flashes.

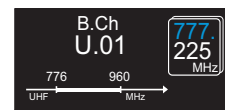

Storing a setting

- ▶ Press the save button ⑧ to store the setting. An animation appears on the display, indicating that the setting has been stored. The display then changes to the selection mode of the operating menu.



Exiting the operating menu/cancelling an entry

You can exit the operating menu or cancel an entry at any time.

- ▶ Press the esc button ⑥.
An animation appears. The display then returns to the previous menu level. To return to status display, you may have to press the esc button ⑥ several times in succession.

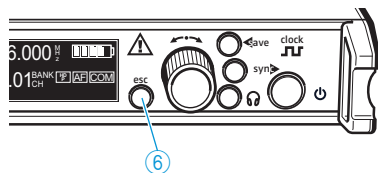

Overview of the menus

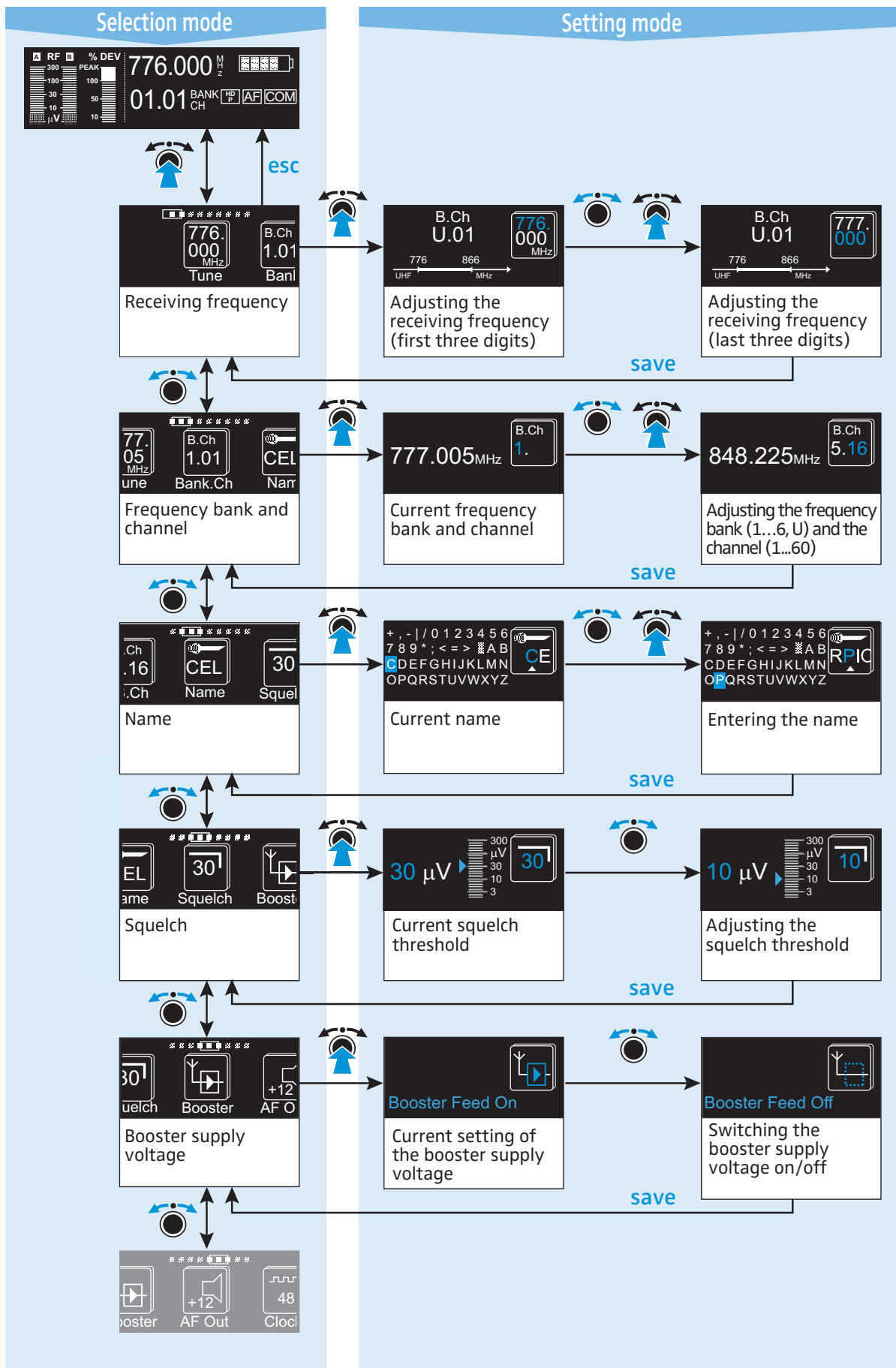

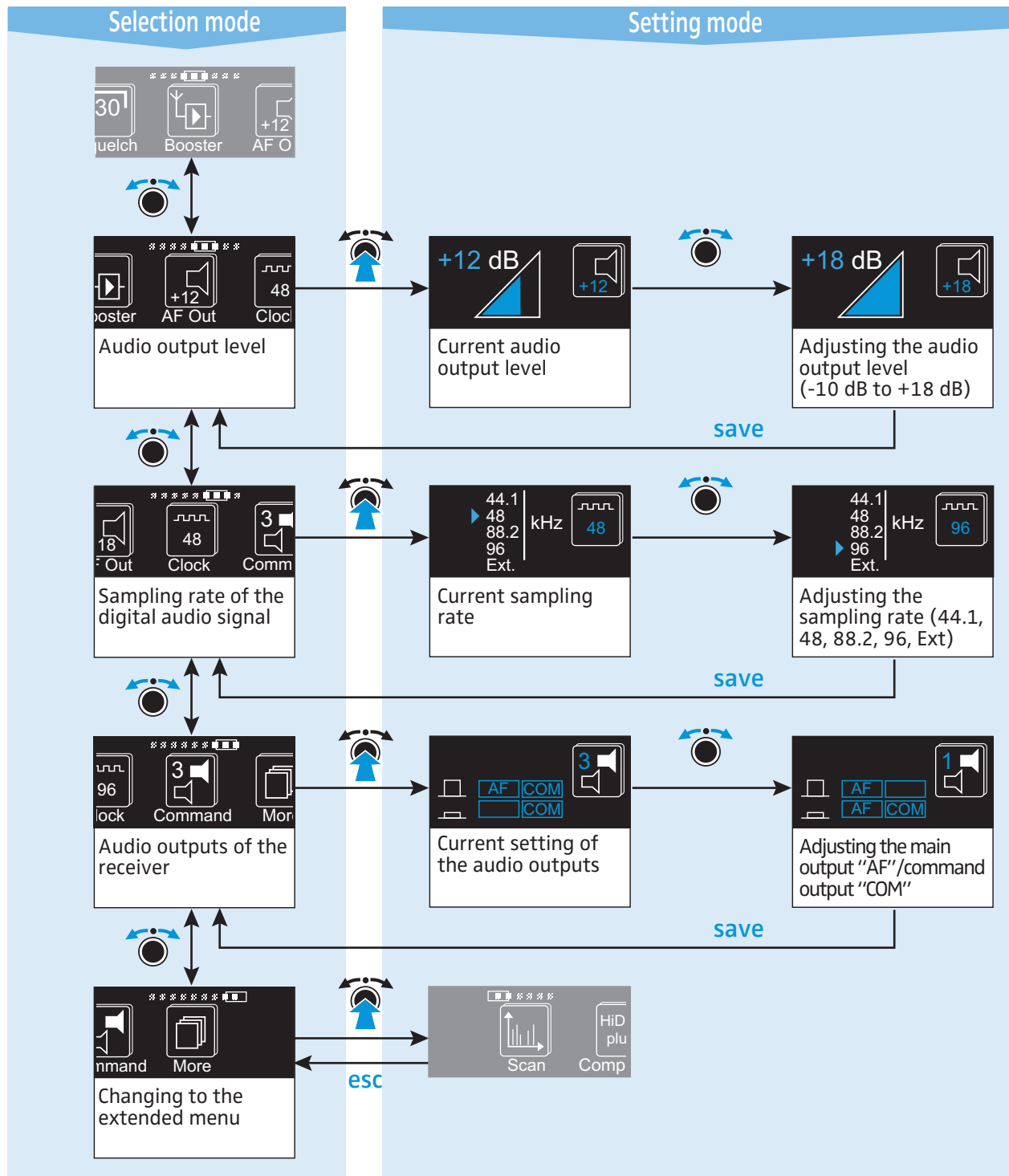

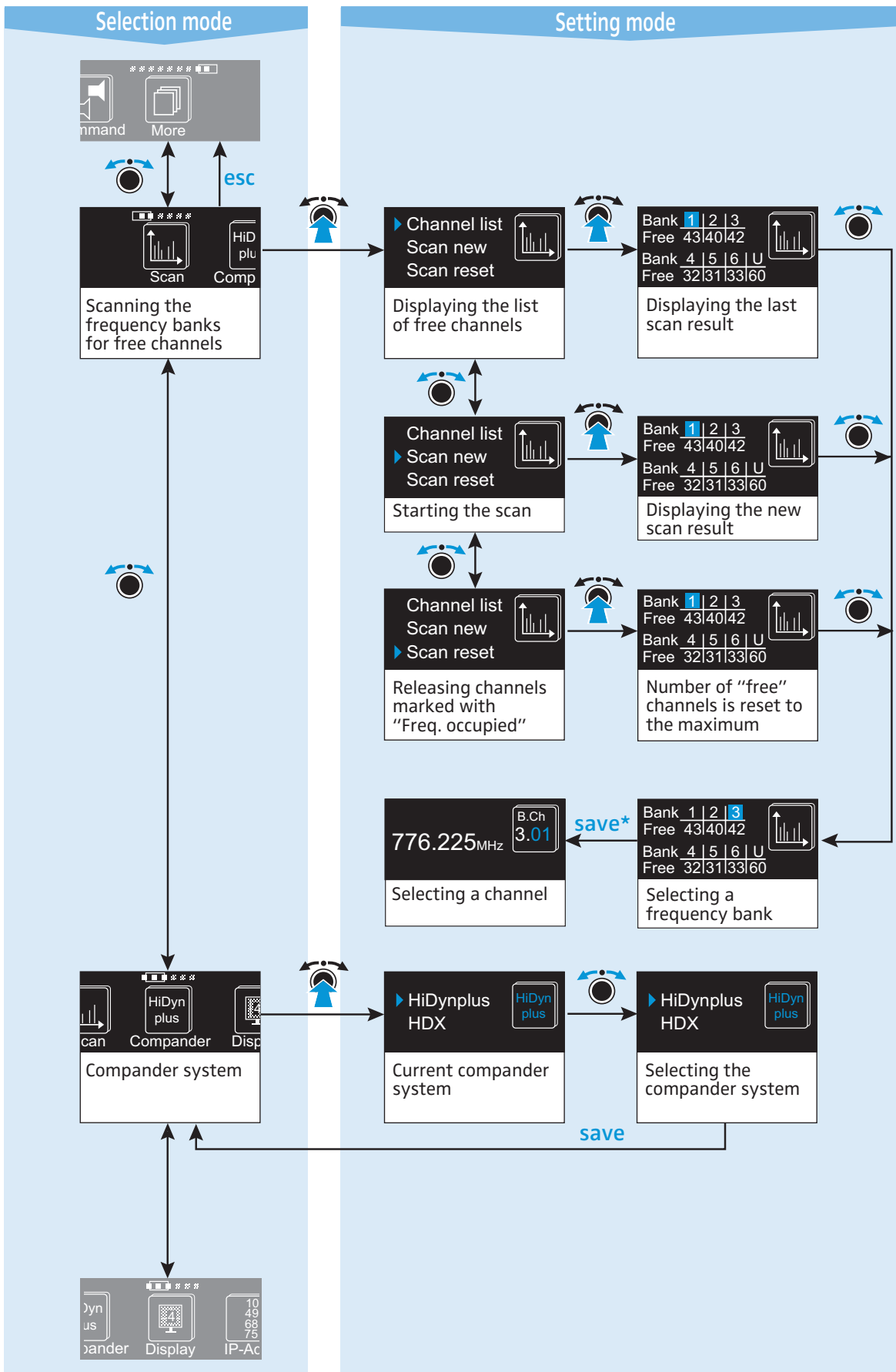

* After pressing the **save** button (Ⓢ), the display automatically changes to the "Bank.Ch" menu (see page 25) – i.e. to the selected frequency bank.

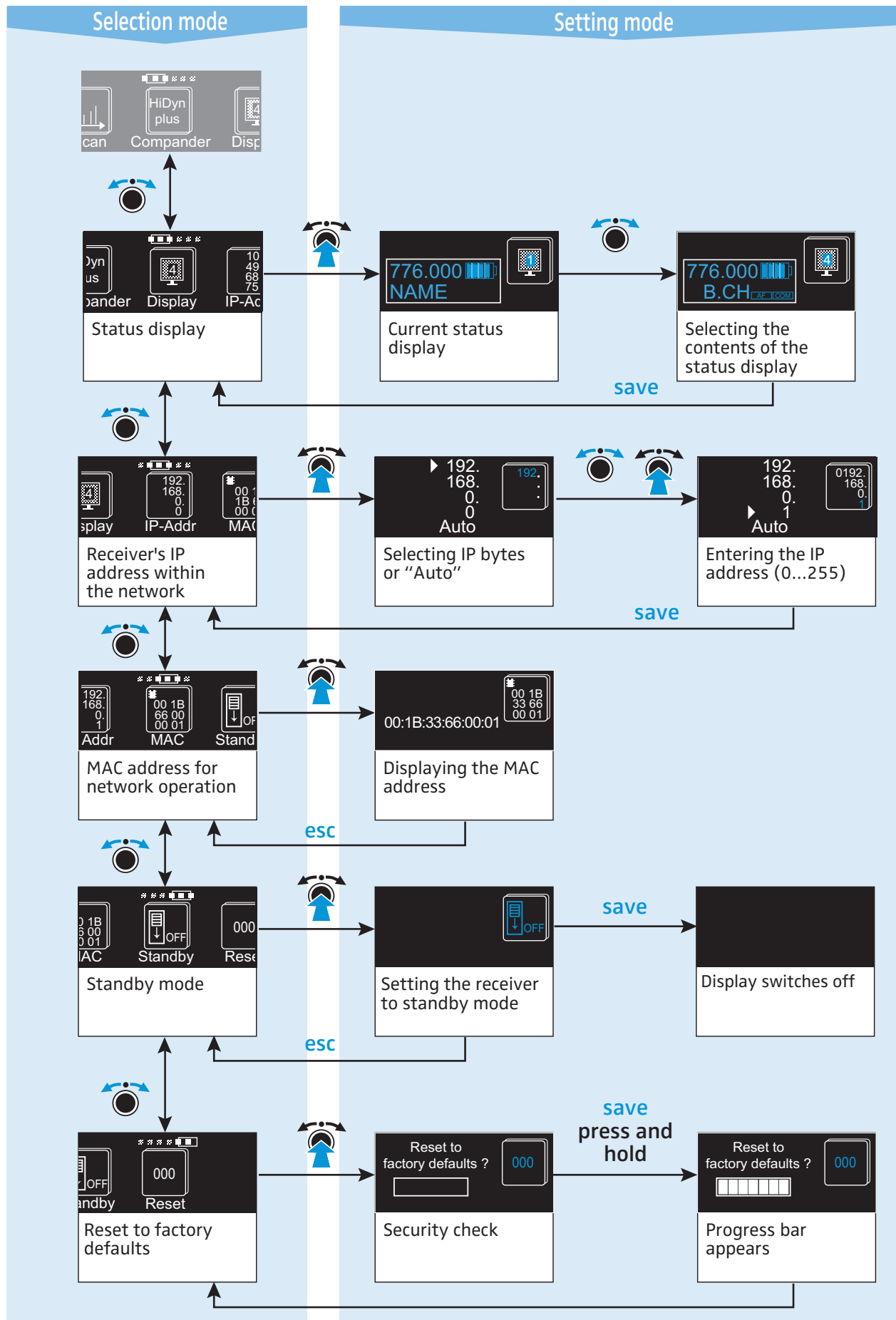

Adjustment tips for the operating menu

The following adjustment tips apply to the operating menus of all receivers of the product family.

Setting the receiving frequency

Via the "Tune" menu, you can:

- set the receiver to a receiving frequency that can be freely selected within the preset frequency range. The receiving frequencies are tuneable in 5-kHz steps within the switching bandwidth of 184 MHz max. If you want to use a receiving frequency from the enclosed frequency tables instead, see "Selecting a frequency bank and a channel" on page 29
- change and store the receiving frequencies in the 60 channels of the frequency bank "U" (see page 30)

- ▶ Change to the setting mode of the "Tune" menu. The first three digits of the receiving frequency start flashing.

- ▶ Change the first three digits of the receiving frequency by turning the jog dial ⑦.

- ▶ Confirm the first three digits of the receiving frequency by pressing the jog dial ⑦. The last three digits of the receiving frequency start flashing.

- ▶ Change the last three digits of the receiving frequency by turning the jog dial ⑦.

- ▶ After you have selected all six digits of the receiving frequency, press the save button ⑧.

The receiving frequency is set and automatically stored on the channel "01" of the frequency bank "U", i.e. the previously stored frequency is overwritten. The display changes to the selection mode of the operating menu.

Selecting a frequency bank and a channel

Via the "Bank.Ch" menu, you can select a frequency bank and a channel from the enclosed frequency tables.

- ▶ Change to the setting mode of the "Bank.Ch" menu. The number of the frequency bank starts flashing.

- ▶ Select the desired frequency bank by turning the jog dial ⑦.

- ▶ Confirm the frequency bank by pressing the jog dial ⑦. The number of the channel starts flashing.

- ▶ Select the desired channel by turning the jog dial ⑦.

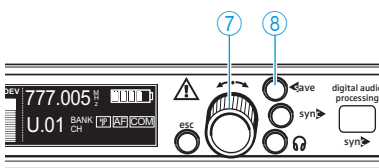
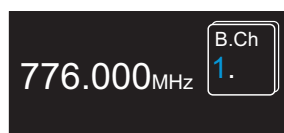
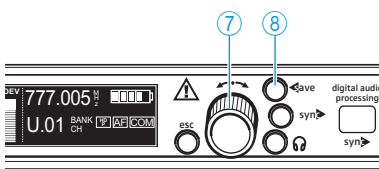
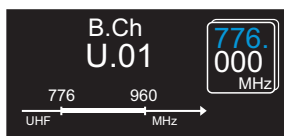
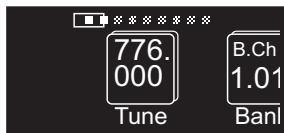

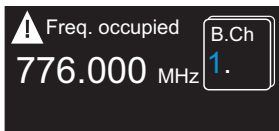

You can only select channels that are not occupied. If, during the last scan, channels were detected that were occupied, these channels are marked with a warning triangle and "Freq. occupied".

- ▶ After you have selected the frequency bank and the channel, press the **save** button (8). The selected frequency bank and the selected channel are set. The display changes to the selection mode of the operating menu.

Changing the receiving frequency for a channel in the frequency bank "U"

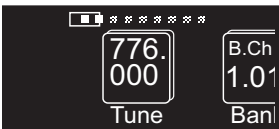

Each receiver has seven frequency banks. Each of the channels in the frequency banks "1" to "6" has been factory-preset to a receiving frequency (see enclosed frequency tables). The frequency bank "U" (user bank) has 60 channels to store your selection of receiving frequencies. Via the "Tune" menu, you can select the receiving frequencies to be stored in the frequency bank "U".

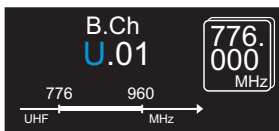

- ▶ Change to the setting mode of the "Bank.Ch" menu and select the frequency bank "U" and one of the channels "01" to "60" whose frequency you want to change and store (see "Selecting a frequency bank and a channel" on page 29).



The receiving frequencies of the channels in the frequency banks "1" to "6" cannot be changed. When you have selected one of the frequency banks "1" to "6" and then select the "Tune" menu, the receiver automatically switches to channel "01" of the frequency bank "U".

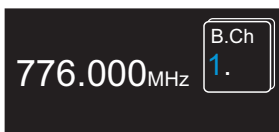

- ▶ Change to the setting mode of the "Tune" menu and select the receiving frequency you want to store (see "Setting the receiving frequency" on page 29). The selected receiving frequency is set and stored on the selected channel of the frequency bank "U", i.e. the previously stored frequency is overwritten. The display changes to the selection mode of the operating menu.

Entering a name



Via the "Name" menu, you can enter a freely selectable name for the receiver. The name can be displayed on the status display and can consist of up to six characters such as:

- letters (without pronunciation marks),
- number from 0 to 9,
- special characters and spaces.



- ▶ Change to the setting mode of the "Name" menu. The first character of the name starts flashing.

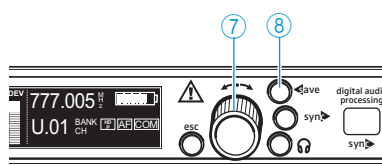

- ▶ Turn the jog dial (7) to select a different character. The selected character starts flashing.
- ▶ Press the jog dial (7) to confirm the selected character. The first character is accepted and stops flashing. The next character starts flashing.
- ▶ Repeat the last two steps to enter the remaining characters.

- ▶ After you have entered the six characters of the name, press the **save** button (8).
The name is stored. The display changes to the selection mode of the operating menu.

In order that the name is displayed on the status display, you may have to change the status display (see "Selecting the status display" on page 38).

Adjusting the squelch threshold



Both receivers are equipped with a squelch that can be adjusted via the "Squelch" menu. The squelch eliminates annoying noise when the transmitter is switched off. It also suppresses sudden noise when there is no longer sufficient transmitter power received by the receiver.

The squelch can be adjusted in 13 steps from 0 to 30 μV . Selecting a smaller value reduces the squelch threshold, selecting a higher value increases the squelch threshold. Adjust the squelch threshold – with the transmitter switched off – to the lowest possible value that suppresses hissing noise.

- i** If you adjust the squelch threshold to a high value, the transmission range will be reduced. Therefore, always adjust the squelch threshold to the lowest possible setting.

If you adjust the squelch threshold to "0", the squelch is switched off. If no RF signal is being received, hissing noise will occur. This setting is for test purposes only.

To adjust the squelch threshold:

- ▶ Before adjusting the squelch threshold to a different setting, set the volume on a connected amplifier to the minimum.
- ▶ Change to the setting mode of the "Squelch" menu.
The current setting starts flashing.
- ▶ Turn the jog dial (7) to change the squelch threshold.
The new setting becomes effective immediately.
- ▶ After you have adjusted the desired squelch threshold, press the **save** button (8).
The squelch threshold is stored. The display changes to the selection mode of the operating menu.

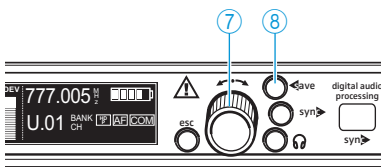
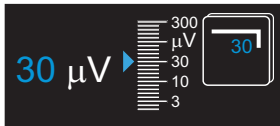

Switching the booster supply voltage on/off



If you connect antenna boosters (e.g. AB 3700) or active antennas (e.g. A 3700, AD 3700), select "Booster Feed On" in the "Booster" menu so that the LEDs (24) and (29) light up;
if you do not connect antenna boosters or active antennas, select "Booster Feed Off" in the "Booster" menu so that the LEDs (24) and (29) do not light up.

- i** The booster supply voltage is short-circuit proof.
If you connect active antennas or antenna boosters, the current consumption of the overall device is increased.

If the booster supply voltage is switched on, it remains switched on even when the receiver is switched off or muted.

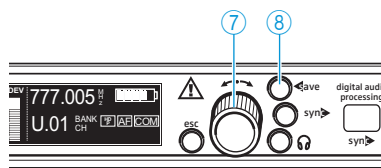
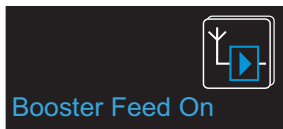

- ▶ Change to the setting mode of the “Booster” menu. The current setting starts flashing.
- ▶ Turn the jog dial ⑦ to change the setting to “Booster Feed On” or “Booster Feed Off”.
- ▶ Press the save button ⑧. The selected setting is stored. When the booster supply voltage is switched on, the two LEDs ⑳ and ㉑ light up. The display changes to the selection mode of the operating menu.

Adjusting the audio output level



Via the “AF Out” menu, you can adjust the maximum output level of the audio outputs (AF Out and Command).

With the EM 3732 COM-II twin receiver, the audio level of the Command output 1 ㉒ corresponds to the level of the audio output 1 ㉓ and the audio level of the Command output 2 ㉔ corresponds to the level of the audio output 2 ㉕.

The following figures are a guide to the best settings:

- Line level: +5 to +18 dB
- Microphone level: -10 to +4 dB

To obtain the best signal-to-noise ratio, adjust the respective maximum audio level to the settings shown above.

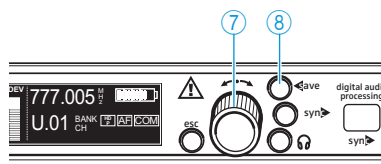

- ▶ Change to the setting mode of the “AF Out” menu. The current setting starts flashing.
- ▶ Turn the jog dial ⑦ to adjust the audio output level. The display shows the selected audio output level.
- ▶ Press the save button ⑧. The selected setting is stored. The display changes to the selection mode of the operating menu.

Selecting the sampling rate for digitalization

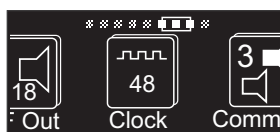

Via the “Clock” menu, you can select the sampling rate with which the analog signal is digitalized and output via the digital balanced XLR-3M audio output ⑰. You can choose between the sampling rates “44.1 kHz”, “48 kHz”, “88.2 kHz”, “96 kHz” and “Ext.”.

“Ext.” means that the receiver will use one of above sampling rates from the external word clock generator. In this case, you first have to connect an external word clock generator to the BNC socket ⑱ (see “Connecting an external word clock generator” on page 17) and switch it on.

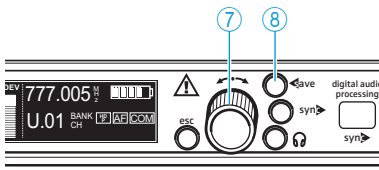
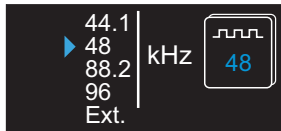

- ▶ Change to the setting mode of the “Clock” menu. The current setting starts flashing.

- ▶ Turn the jog dial (7) to select the desired sampling rate.
- ▶ Press the **save** button (8). The selected sampling rate is stored. The display changes to the selection mode of the operating menu.



If you select “Ext.” even though no external word clock signal is available at the BNC socket for word clock input (18) (e.g. because the external word clock generator is not connected or switched off), the display for external word clock synchronization (12) starts flashing and the last set sampling rate remains active.

The receiver’s audio outputs have a latency which depends on the sampling rate set in the “Clock” menu. The below table shows these latency times as well the distances* to which they approximately correspond.

Audio output	Sampling rate kHz	Latency ms	Corresponds to a distance of approx. ... cm*
Analog	44.1 / 88.2	1.8	60
Analog	48 / 96	1.7	55
Digital	44.1	1.9	65
Digital	48	1.7	55
Digital	88.2	1.8	60
Digital	96	1.7	55

Configuring the audio outputs of the EM 3732 COM-II

The EM 3732 COM-II twin receiver has two audio outputs per receiver:

1. the audio outputs AF Out 1 (23) and AF Out 2 (21),
2. the command outputs Command 1 (22) and Command 2 (20).

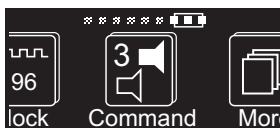

These audio outputs can be switched on and off via a button on the transmitter – provided that the transmitter is also equipped with the command function (a separate power pack with command button is available for the SKM 5200 transmitter).

* “distance” describes the listening distance to the sound source.

Via the “Command” menu, you can determine which of the audio and command outputs will be switched on and off when the command button on the transmitter is pressed. There are four configuration options:

WHEN the “Command” menu of the receiver is configured as shown AND the command button on the transmitter is THEN the receiver’s audio outputs are switched ...
	<input type="checkbox"/> not pressed	AF Out: on Command: off
	<input checked="" type="checkbox"/> pressed	AF Out: on Command: on
	<input type="checkbox"/> not pressed	AF Out: on Command: off
	<input checked="" type="checkbox"/> pressed	AF Out: off Command: on
	<input type="checkbox"/> not pressed	AF Out: on Command: on
	<input checked="" type="checkbox"/> pressed	AF Out: off Command: on
	<input type="checkbox"/> not pressed	AF Out: on Command: on
	<input checked="" type="checkbox"/> pressed	AF Out: on Command: on

The active output lights up in the command display; muted outputs are not displayed (see “Command display (status display of the audio outputs AF and Command)” on page 12).

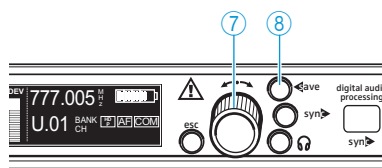

- ▶ Change to the setting mode of the “Command” menu. The current configuration starts flashing.
- ▶ Select one of the four configurations by turning the jog dial ⑦.
- ▶ If you do not want to use the command function, select the configuration “4”.
- ▶ Press the save button ⑧. The selected configuration is stored. The display changes to the selection mode of the operating menu.

Changing to the extended menu



Via the “More” menu, you can change to the extended menu with the menus “Scan”, “Compander”, “Display”, “IP-Addr”, “MAC”, “Standby” and “Reset”.

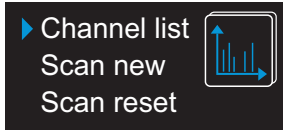
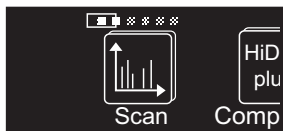

Scanning the frequency banks for interference-free channels

Via the "Scan" menu, you can scan all frequency banks for free channels.

- ▶ Change to the setting mode of the "Scan" menu. The following selection appears:
 - "Channel list" displays the number of free channels for each frequency bank from the last scan.
 - „Scan new" scans all frequency banks and displays the number of free channels for each frequency bank.
 - „Scan reset" releases channels that were occupied or subject to interference during the last scan (these channels are marked with a warning triangle and "Freq. occupied").

Displaying a list of all free channels

Via the "Channel list" menu, you can display the last scan result. You can then select a suitable frequency bank and a channel.

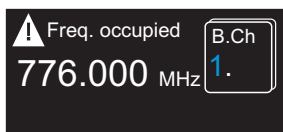
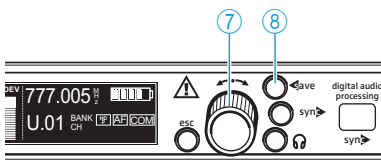
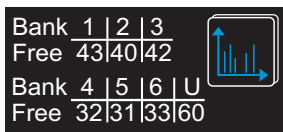
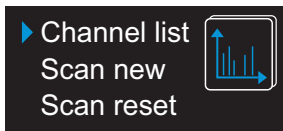

- ▶ Turn the jog dial (7) until the arrow points to "Channel list".
- ▶ Press the jog dial (7). A table displays the number of free channels for each of the seven frequency banks.
- ▶ Turn the jog dial (7) to select a frequency bank with a sufficient number of free channels.
- ▶ Press the save button (8). The selected frequency bank is automatically called up in the "Bank.Ch" menu.
- ▶ Select a channel from this frequency bank (see "Selecting a frequency bank and a channel" on page 29).



After the scan, the channels that are occupied or subject to interference are marked with a warning triangle and "Freq. occupied".

Starting the scan

Via the “Scan new” menu, you can scan all frequency banks for free channels. The last scan result is overwritten.

- ▶ Before starting the scan, switch all transmitters of your system **off**, since channels used by switched-on transmitters will not be displayed as “free channels”.

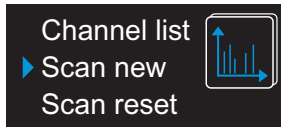

- ▶ Turn the jog dial ⑦ until the arrow points to “Scan new”.
- ▶ Press the jog dial ⑦ to start the scan.

The receiver scans the frequency banks one after the other for free channels. This can take several minutes. After the scan, a table displays the number of free channels for each frequency bank and the green backlighting of the **save** button ⑧ flashes.

- ▶ You can cancel the scan at any time by pressing the **esc** button ⑥. The display changes to the setting mode of the “Scan” menu and the last scan result is restored.

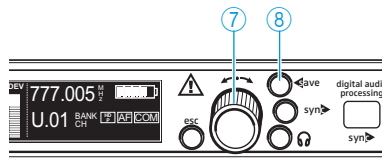

- ▶ Turn the jog dial ⑦ to select a frequency bank with a sufficient number of free channels.

- ▶ Press the **save** button ⑧.

The selected frequency bank is automatically called up in the “Bank.Ch” menu.

- ▶ Select a channel from this frequency bank (see “Selecting a frequency bank and a channel” on page 29).

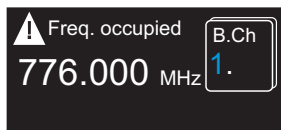

- ▶ After the scan, the channels that are occupied or subject to interference are marked with a warning triangle and “Freq. occupied”.

Releasing channels that are used or subject to interference

After the scan, the channels that are occupied or subject to interference are marked with a warning triangle and “Freq. occupied”. Via the “Scan reset” menu, you can unmark these channels. The last scan result is deleted.

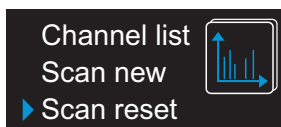

- ▶ Turn the jog dial ⑦ until the arrow points to “Scan reset”.

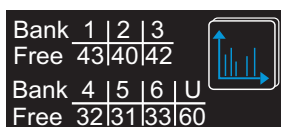

- ▶ Press the jog dial ⑦.

The number of free channels is reset to the maximum for all frequency banks.

- ▶ Turn the jog dial ⑦ to select a frequency bank.

- ▶ Press the **save** button ⑧.

The selected frequency bank is automatically called up in the “Bank.Ch” menu.

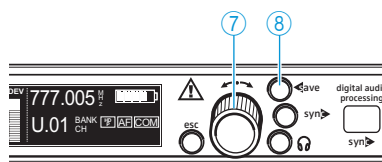

Multi-channel operation

Combined with Sennheiser 3000 and 5000 series transmitters, the receivers can form transmission links that are suitable for multi-channel operation.

CAUTION! Risk of reception interference!



If – within the receiver's frequency range – transmitters transmit on channels from different frequency banks, reception can be subject to interference and inter-modulation. Only the factory-preset frequencies within the frequency banks "1" to "6" are interference and intermodulation free.

- ▶ Set all transmitters of a multi-channel system to different channels within the same frequency bank.

Before putting the transmission links into operation, we recommend that you perform a scan in order to find a frequency bank with a sufficient number of free channels:

- ▶ Switch all transmitters off.
- ▶ Use a receiver to scan all frequency banks for free channels (see "Scanning the frequency banks for interference-free channels" on page 35).
- ▶ Select a frequency bank with a sufficient number of free channels (see "Selecting a frequency bank and a channel" on page 29).
- ▶ Set each transmitter/receiver pair in your multi-channel system to a different free channel within this frequency bank.

Selecting the compander system

Your receiver supports both the HiDyn *plus*[™] (HDP) and HDX compander systems. The active compander system is shown on all status displays (see page 38).

To select the compander system:

- ▶ From the extended menu "More", select the "Compander" menu. The current compander system flashes.
 - ▶ Turn the jog dial ⑦ to select the desired compander system.
 - ▶ Press the **save** button ⑧.
- The selected compander system is activated. The display changes to the selection mode of the operating menu.



With the EM 3732-II twin receiver and EM 3732-II Command twin receiver, the selected compander system is activated for both the left hand and right hand receivers.

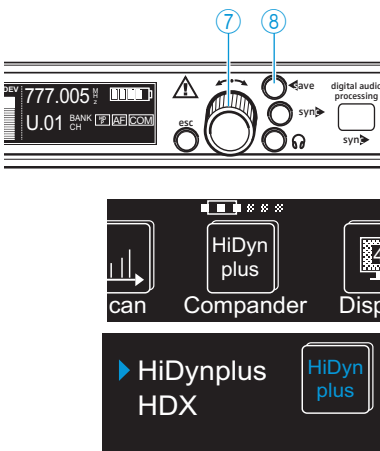



Selecting the status display

Via the "Display" menu, you can select the status display:

Selectable status display	Contents of the display
1. "Name" displays the freely selectable name	776.000 MHz [Battery Icon] NAME [HD P]
2. "Bank/Channel" displays the frequency bank and the channel number	776.000 MHz [Battery Icon] 01.01 BANK CH [HD P]
3. "Name/Command" displays the freely selectable name and the command display (EM 3732 COM-II receiver only)	776.000 MHz [Battery Icon] NAME [HD P] [AF] [COM]
4. "Bank/Channel/Command" displays the frequency bank, the channel number and the command display (EM 3732 COM-II receiver only)	800.450 MHz [Battery Icon] 03.03 BANK CH [HD P] [AF] [COM]

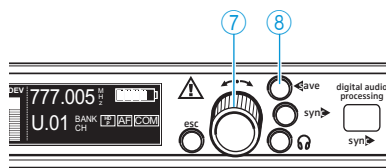

- ▶ Change to the setting mode of the "Display" menu. The current status display starts flashing.

- ▶ Turn the jog dial ⑦ to select one of the four status displays.
 - ▶ Press the save button ⑧.
- The selected status display becomes effective. The display changes to the selection mode of the operating menu.

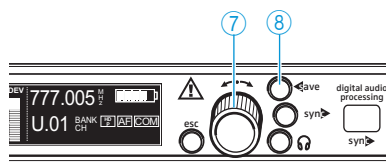
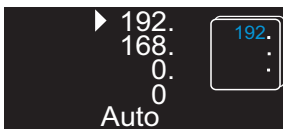

Changing the IP address

Via the "IP-Addr" menu, you can display and change the receiver's IP address. The IP address consists of four bytes and each byte consists of up to three digits (from 0 to 255). The receiver is factory-preset to dynamic IP addressing ("Auto").

To **manually** assign an IP address:

- ▶ Change to the setting mode of the "IP-Addr" menu. The first byte starts flashing.
- ▶ Turn the jog dial ⑦ to select a value between 0 and 255.
- ▶ Press the jog dial ⑦ to confirm the first byte and change to the next byte.
- ▶ Repeat the last two steps to enter all four bytes.
- ▶ After you have selected the complete IP address, press the save button ⑧.
- ▶ Switch the receiver off and on again (see page 19). The new IP address becomes effective.

To **automatically** obtain an IP address (dynamic IP addressing):

- ▶ Change to the setting mode of the “**IP-Addr**” menu.
The first byte starts flashing.
- ▶ Press the jog dial ⑦ repeatedly until the arrow points to “**Auto**”.
- ▶ Press the **save** button ⑧.
- ▶ Switch the receiver off and on again (see page 19).
The new IP address becomes effective.

Displaying the network address (MAC address)

Via the “**MAC**” menu, you can display the Media Access Control (MAC) address of the Ethernet interface. The MAC address is fixedly stored in each receiver and cannot be changed.

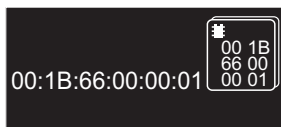

- ▶ Change to the setting mode of the “**MAC**” menu.
The 12-digit MAC address is displayed.

Setting a receiver to standby mode

You can set a receiver to standby mode and mute it. To do so, proceed as follows:

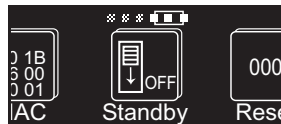

- ▶ Change to the setting mode of the “**Standby**” menu.
The icon and the green backlighting of the **save** button ⑧ flash.

- ▶ Press the **save** button ⑧.
The **esc** button ⑥ is backlit in red. The receiver is set to standby mode and the display is switched off.



The standby mode remains active even when you switch the receiver off and on again.

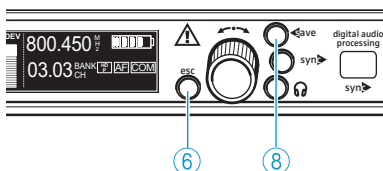

To end the standby mode:

- ▶ Press the jog dial ⑦ or the **esc** button ⑥.
The display is switched on.

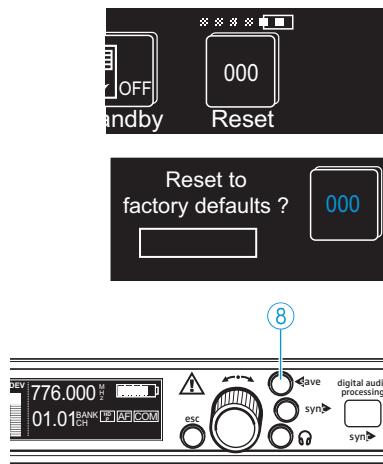

Loading the factory-preset default settings

Via the “Reset” menu, you can reset the current settings to the factory-preset default settings.

- ▶ Change to the setting mode of the “Reset” menu. The query “Reset to factory defaults?” appears. The green backlighting of the save button ⑧ flashes.
- ▶ Press the save button ⑧ until the progress bar is complete. All settings except for the booster supply voltage, the sampling rate at the digital output and the network address are reset to the factory-preset default settings. The display changes to the selection mode of the operating menu.

Cleaning the receiver

-
- CAUTION!** Liquids can damage the electronics of the receiver! Liquids entering the housing of the product can cause a short-circuit and damage the electronics.
- ▶ Keep all liquids away from the receiver.
-

- ▶ Before cleaning, disconnect the product from the mains.
- ▶ Use a dry cloth to clean the product from time to time.

Additional information

HiDyn *plus*[™] (HDP) or HDX noise reduction

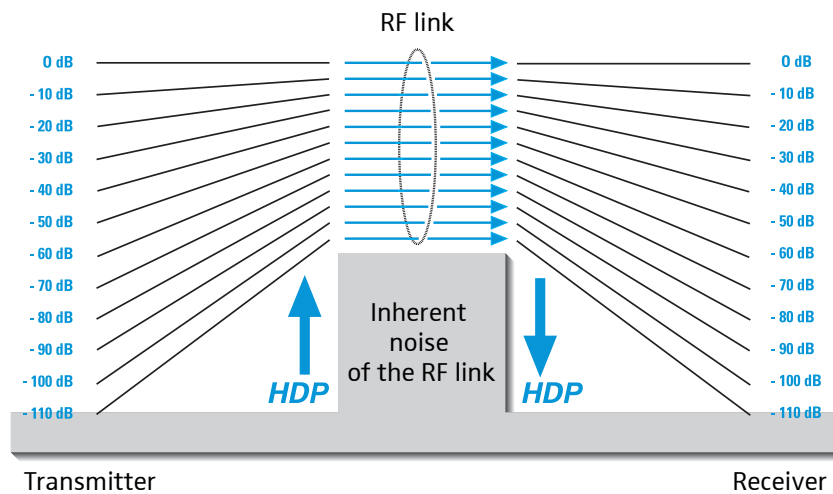

This product family is equipped with the Sennheiser noise reduction systems **HDP** and **HDX**. Both compander systems operate on the same principle (described in the following for HDP) but use different parameters (e.g. time constant, type of control). **HDP** reduces RF interference. It increases the signal-to-noise ratio in wireless audio transmission to more than 110 dB. **HDP** is a wideband compander system which compresses the audio signal in the transmitter in a 2:1 ratio (related to dB) to lift it above the inherent noise floor of the RF link. In the receiver the signal is expanded in an identical and opposite way in a 1:2 ratio to restore the original signal, at the same time reducing the RF noise to below the noise floor of the receiver.

HDP has been specially developed for high quality radio microphone systems.

All receivers of the product family feature a AES3 digital audio output for digital mixing consoles. In the receiver the audio signal is digitalized as early as possible so that the noise reduction (compander) can be realized digitally.



Only transmitters and receivers that are equipped with the same compander system can work correctly with each other. If this is not the case, the dynamic range will be drastically reduced and the transmission will sound blunt and flat.

Squelch

Depending on the strength of the received RF signal, the receiver's audio output is opened or muted. Via the "**Squelch**" menu, the squelch threshold can be adjusted in 13 steps from 0 to 30 μ V.

Diversity reception

The receivers operate on the “true diversity” principle:



A receiving antenna receives not only the electromagnetic waves which reach it by a direct path, but also the reflections of these waves which are created in the room by walls, windows, ceilings and fittings. When these waves are superimposed, destructive interference occurs, which can also be called “field strength gaps”. Repositioning the receiving antenna can bring a solution. With mobile transmitters, however (which all radio microphones are), the “field strength gap” will then occur with a different transmitter position. These “field strength gaps” can only be eliminated with true diversity receivers.

In true diversity, instead of one antenna and one receiver there are now two antennas and two receiver sections. The antennas are spatially separated. By means of a comparison circuit, the receiver section with the strongest RF signal is always switched to the common AF output. The risk of the occurrence of “field strength gaps” in both antennas at the same time is virtually nonexistent.

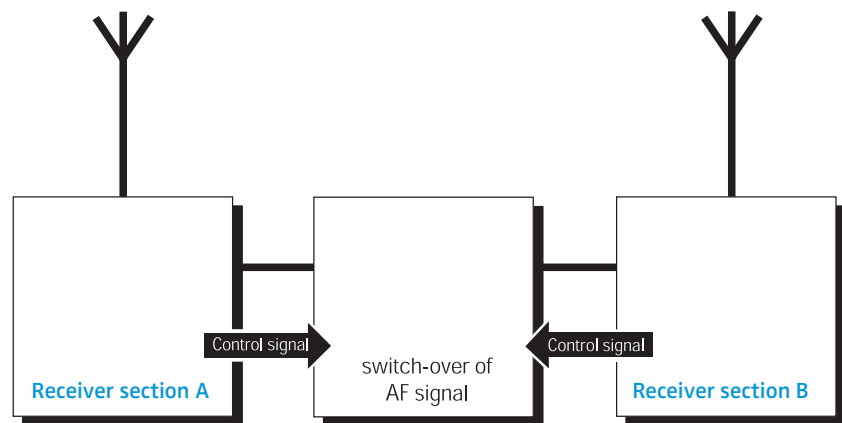
The receiver display panel shows the active diversity section (A or B) (see “Diversity display” on page 10).



If a problem occurs

Problem	Possible cause	Possible solution
No operation indication	No mains connection	Check the connections of the mains cable.
No RF signal	Transmitter and receiver are not on the same channel	Set transmitter and receiver to the same channel (see "Selecting a frequency bank and a channel" on page 29 and "Synchronizing a transmitter with the receiver" on page 20).
	The transmission range is exceeded	Reduce the distance between transmitter and receiver. Check the squelch threshold setting (see page 31).
Frequency cannot be transferred to the transmitter	The transmitter is not within the range of the infra-red interface	Place the transmitter at a distance of approx. 5 cm in front of the infra-red interface (see page 20).
	The infra-red interface of the receiver is not yet ready for transferring the frequency; the receiver is still in scan mode	Press the esc button  to stop the scan.
	The transmitter is from a different frequency range	Use a transmitter that matches the frequency range of the receiver.
	The HDX compander system is activated on the receiver	Activate the HDP compander system on the receiver (see page 37).
	The transmitter's compander system is not compatible	Use a transmitter equipped with the HDP compander system (see page 20).
The audio signal has a high level of background noise	The transmitter sensitivity is adjusted too low	Adjust the transmitter sensitivity correctly.
	The receiver's AF output level is adjusted too low	See "Adjusting the audio output level" on page 32.
The audio signal is distorted	The transmitter sensitivity is adjusted too high	Adjust the transmitter sensitivity correctly.
	The receiver's AF output level is adjusted too high	See "Adjusting the audio output level" on page 32.
The display does not switch on	The receiver is in standby mode	Press the jog dial  (see "Setting a receiver to standby mode" on page 39).
„MUTE“ is permanently displayed	One of the two receivers is not used or the transmitter is switched off or out of range	Set the receiver to standby mode (see page 39).

If a problem occurs that is not listed in the above table or if the problem cannot be solved with the proposed solutions, please contact your local Sennheiser partner for assistance.

To find a Sennheiser partner in your country, search at www.sennheiser.com under "Service & Support".

Accessories

Cat. No.	Accessory	Cat. No.	Accessory
502195	A 3700 active broadband antenna, omni-directional	004368	GA 3030 AM antenna mount
502197	AD 3700 active broadband antenna, directional	087969	Antenna daisy chain cable, 50 Ω , BNC, 0.25 m
502196	AB 3700 antenna booster	087972	Word clock daisy chain cable, 75 Ω , BNC, 0.25 m
500887	A 5000 CP circularly polarized broadband antenna, passive	502432	GZL AES 10 AES3 cable, 10 m, 110 Ω , double-shielded
004645	A 1031 broadband remote antenna, passive	002324	GZL 1019-A1 coaxial cable, type RG 58, BNC to BNC, 1 m
003658	A 2003 broadband directional antenna, passive	002325	GZL 1019-A5 coaxial cable, type RG 58, BNC to BNC, 5 m
009423	ASA 3000-EU antenna splitter	002326	GZL 1019-A10 coaxial cable, type RG 58, BNC to BNC, 10 m
009407	ASA 3000-US antenna splitter		
009408	ASA 3000-UK antenna splitter		

Specifications

RF characteristics

Modulation	wideband FM
Frequency ranges	Range L: 470 to 638 MHz Range N: 614 to 798 MHz Range N-GB: 606 to 790 MHz Range P: 776 to 960 MHz
Receiving frequencies (per receiver RX 1 or RX 2)	6 frequency banks with up to 59 factory-preset frequencies each, 1 frequency bank with up to 60 freely selectable frequencies (tuneable in 5-kHz steps)
Switching bandwidth	up to 184 MHz
Frequency stability	$\leq \pm 2.5$ ppm
Receiver principle	true diversity
Sensitivity (with HDP, peak deviation)	typ. 1.5 μ V at 52 dB(A)rms S/N typ. 15 μ V at 115 dB(A)rms S/N
Adjacent channel rejection/ spacing	typ. 75 dB/ ± 400 kHz typ. 80 dB/ ± 800 kHz
Intermodulation attenuation	≥ 80 dB
Blocking	≥ 80 dB
Squelch	13 steps (0 ... 30 μ V)
Antenna inputs	2 BNC sockets (50 Ω)
Daisy chain outputs	2 BNC sockets (50 Ω) amplification: 0 dB \pm 0.5 dB (related to the antenna inputs) 184 MHz typ. bandwidth (range)

AF characteristics

Compander system, DSP-emulated	Sennheiser HiDyn <i>plus</i> [™] , (HDP) Sennheiser HDX
AF bandwidth	40–20,000 Hz
Latency	≤ 1.9 ms
Nominal/peak deviation	± 40 kHz/ ± 56 kHz
Signal-to-noise ratio (1 mV, peak deviation)	≥ 118 dB(A) at +18 dBu/+4 dBu(AF Out)
THD (nominal deviation, 1 kHz)	$\leq 0.3\%$
AF output voltage (peak deviation, 1 kHz _{AF})	+18 dBu to –10 dBu, adjustable in 1-dB steps (transformer balanced)
AF output sockets	1 XLR-3 socket per receiver, 2 XLR-3 sockets per EM 3732 COM-II receiver
Headphone output	2 x 100 mW at 32 Ω 10 Ω internal impedance short-circuit proof

Overall device

Current consumption	max. 0.4 A
Power consumption	with receiver switched on: max. 20 W (50 VA) with receiver switched off, booster supply voltage switched on: max. 9.5 W with receiver and booster supply voltage switched off: max. 4 W
Mains connector	3-pin, protection class I, as per IEC/EN 60320-1
Dimensions W x D x H [mm]	436 x 215 x 44 (without rack mount "ears")
Weight	approx. 4080 g (incl. rack mount "ears") approx. 3600 g (without rack mount "ears")
Booster supply	12 V DC via antenna socket max. 200 mA each, short-circuit proof, switchable
Ethernet	IEEE 802.3-2002, shielded RJ 45 socket with optional locking facility
Digital output	AES3-2003, XLR-3, 44.1, 48, 88.2 or 96 kHz SR, 24 bits, externally synchronizable
Word clock connection	2 BNC sockets (75 Ω), daisy chain output
Accepted sampling rates	44.1 kHz, 48 kHz, 88.2 kHz, 96 kHz
Word clock input	75 Ω, transformer balanced, AC-coupled input voltage range 200 mV ... 5 V _{pp} max. input voltage 15 V (DC + AC)
Word clock output	75 Ω, transformer balanced, AC-coupled output voltage 2.5 V ± 250 mV at 75 Ω source impedance



Operating conditions

Ambient temperature	-10°C to +55°C
Relative humidity	max. 85% at 40°C (non condensing)
Power supply	100 to 240 V~, 50/60 Hz
Protection against dripping and splashing	the product must not be exposed to dripping and splashing (IP 20)

Storage and transport conditions

Ambient temperature	-25°C to +70°C
Relative humidity	max. 90% at 40°C
Protection against dripping and splashing	the product must not be exposed to dripping and splashing (IP 20)
Shock test	shock test according to IEC 68 or EN 60068, T2-27

In compliance with

Europe		EMC	EN 301489-1/-9
		Radio	EN 300422-1/-2
		Safety	EN 60065
USA		47 CFR 15	subpart B
Approved by	Industry Canada	RSS-123, IC: 2099A-EM373X2	

Manufacturer Declarations

Warranty

Sennheiser electronic GmbH & Co. KG gives a warranty of 24 months on this product.

For the current warranty conditions, please visit our web site at www.sennheiser.com or contact your Sennheiser partner.

In compliance with

- RoHS Directive (2002/95/EC)

CE Declaration of Conformity

- 
- R&TTE Directive (1999/5/EC), Low Voltage Directive (2006/95/EC)

The declarations are available at www.sennheiser.com.

Before putting the device into operation, please observe the respective country-specific regulations.

Statements regarding FCC and Industry Canada

This device complies with Part 15 of the FCC Rules and with RSS-123 of Industry Canada. Operation is subject to the following two conditions: (1) this device may not cause harmful interference, and (2) this device must accept any interference received, including interference that may cause undesired operation.

This equipment has been tested and found to comply with the limits for a Class B digital device, pursuant to Part 15 of the FCC Rules. These limits are designed to provide reasonable protection against harmful interference in a residential installation. This equipment generates, uses and can radiate radio frequency energy and, if not installed and used in accordance with the instructions, may cause harmful interference to radio communications. However, there is no guarantee that interference will not occur in a particular installation. If this equipment does cause harmful interference to radio or television reception, which can be determined by turning the equipment off and on, the user is encouraged to try to correct the interference by one or more of the following measures:

- Reorient or relocate the receiving antenna.
- Increase the separation between the equipment and receiver.
- Connect the equipment into an outlet on a circuit different from that to which the receiver is connected.
- Consult the dealer or an experienced radio/TV technician for help.

This class B digital device complies with the Canadian ICES-003.

Changes or modifications made to this equipment not expressly approved by Sennheiser electronic Corp. may void the FCC authorization to operate this equipment.

Before putting the device into operation, please observe the respective country-specific regulations!

Sennheiser electronic GmbH & Co. KG

Am Labor 1, 30900 Wedemark, Germany
www.sennheiser.com

Printed in Germany, Publ. 10/10, 542644/A01

