

Headload Prodigy™

Load Box and Amp DI



User Guide



CAUTION!



The Headload Prodigy is a load box that is designed to safely handle and attenuate up to 120 watts RMS of power from a guitar or bass amplifier. The Headload Prodigy is intended for 8 Ohm. For best performance and proper power transfer, **NEVER EXCEED THE PRODIGY'S 120 WATT POWER RATING** and always match the impedance. Exceeding this power can cause the Headload Prodigy to overheat which could damage the unit. The Headload Prodigy speaker connections employ switching jacks that reroute the signal to the amp and/or internal load resistors. **DO NOT DISCONNECT CABLE AT SPEAKER BOX END AND LEAVE IT CONNECTED TO THE HEADLOAD PRODIGY.**

Radial® Headload Prodigy™

Load Box and Amp DI

Table of Contents	Page
Feature set	1-2
Making Connections	3
How to Use	4-5
JDX Balanced Output	6
JDX Unbalanced Output	7
Using the Features	8-9
Rack Mounting and Cable Length	10
Block Diagram	11
Specifications	12
Warranty	Back Cover

Thank you for purchasing the Headload Prodigy. The Prodigy is a multi-purpose load box that enables you to reduce the output of your speaker cabinet and to send your guitar amp and cabinet sound to the PA or recording system using the built-in JDX direct box output. You can simultaneously set your amp to full output, 50% or 25% volume, or turn it completely off for quiet on-stage performance or late night recording.

Best of all, the Prodigy has been designed to be straight forward and easy to use. However, as with all products, making sure you understand the features will not only improve your musical experience, it will ensure your equipment is safe from damage due to misuse. So please take a few minutes to read through this manual to familiarize yourself with all of the built-in features.

If after reading, you find yourself looking for more answers, please visit the Prodigy FAQ page on the Radial web site. This is where we post updates and questions from users like yourself. If you still do not find what you are looking for, feel free to send us an email at info@radialeng.com and we will do our best to reply in short order.

Now get ready to rock out at full, half or no volume at all.

FRONT PANEL FEATURE SET



1. **HEADPHONE:** ¼" TRS mono summed output for headphones, lets you quietly practice while your amp is being driven hard.
2. **PHONES:** Variable control used to adjust headphone level to suit.
3. **LINE OUT:** Variable control to adjust the level going to the unbalanced ¼" JDX outputs.
4. **EQ:** Lets you fine tune the tone of the JDX output to optimize your wedge monitors or in-ears.
5. **POL 180:** Inverts phase by toggling pin-2 and pin-3 at the XLR out to correct acoustic resonance or to help phase-align the direct out with a microphone.
6. **POWER:** LED indicator lets you know the Prodigy is activated.
7. **HANDLE:** Makes it easy to carry your Prodigy around the studio – may be removed for rack mounting.
8. **STEEL CASE:** Solid 14-gauge steel outer shell shields the inner electronics from disruptive magnetic fields generated by the amplifier's power transformer.
9. **VENTS:** Top access ventilation slots allow excess heat to be dissipated without the need of a fan.
10. **BOOK-END DESIGN:** Creates protective zone around the switches and potentiometer to keep them out of harm's way.

REAR PANEL FEATURE SET

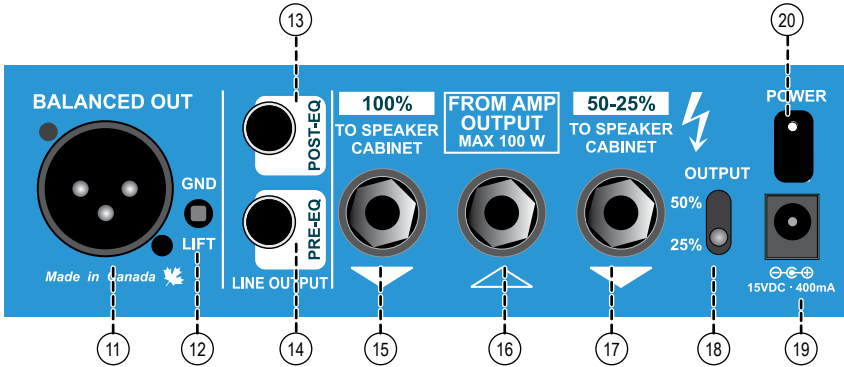

- 11. **BALANCED OUT:** JDX lo-Z balanced mic level output used to feed the PA system, monitors or recorder.
- 12. **GND LIFT:** Lifts pin-1 on the XLR output to help eliminate hum and buzz caused by ground loops.
- 13. **POST-EQ:** Presents a post JDX and post (wet) EQ output to feed a second direct box for recording or external effects processor.
- 14. **PRE-EQ:** Pre-JDX direct output sends the unaffected (dry) direct signal from your amp to feed another stage amp or effects.
- 15. **100% OUTPUT:** ¼" output delivers full output of your amp to the speaker cabinet.
- 16. **FROM AMP:** ¼" input connects signal from your amp head output to the Prodigy.
- 17. **25%-50% OUTPUT:** ¼" output is used to attenuate the volume for quiet on-stage performance.
- 18. **OUTPUT SELECT:** Choose between 50% and 25% output level to the speaker cabinet.
- 19. **POWER:** Connection for the external 15VDC 400mA power supply.
- 20. **CABLE CLAMP:** Secures the DC adapter cable to prevent accidental power disconnect.

MAKING CONNECTIONS

Before making any connections, make sure your guitar amp is turned off and the audio system is either turned down or volume levels turned off. This will protect sensitive components such as tweeters and speakers from turn-on or connection transients. If you are connecting to a preamp or mixer, make sure the 48V phantom power is turned off as it is not required. Always use heavy 14-gauge speaker wires (or heavier if possible) between the Headload Prodigy and your amplifier to ensure optimal signal flow from the head to the speaker cabinet.

The Prodigy does not have a power switch. As soon as you connect the power supply, it will automatically turn on and the front panel power LED will illuminate. A handy cable clamp is provided that can be used to secure the power supply if needed. Simply loosen with a hex key, slip the power supply cable into the cavity and tighten.

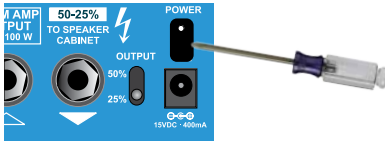

Use a hex driver to loosen the cable lock.

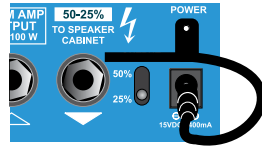

Pass the cable through and re-tighten.

Set the Prodigy controls to the start position with the tone controls to 12 o'clock, the two level controls to off (7 o'clock), and the ground lift and polarity reverse switches in the outward position. The rear panel ground lift switch is recessed to prevent accidental changes during a show. To activate, use a small screwdriver.

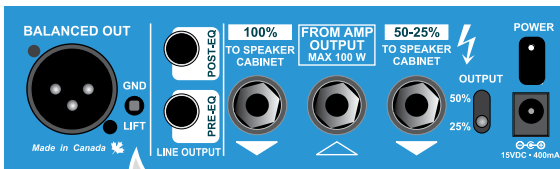
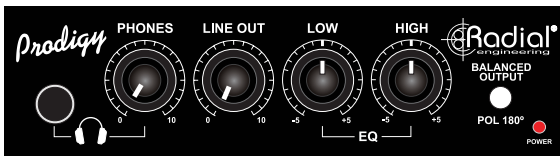

GND LFT in 'out' position

HOW TO USE THE PRODIGY

As the Prodigy may be used in three different ways, it is important that you first determine how you plan to use it before making connections.

1. As a simple direct box
2. For 50% or 75% attenuation
3. For silent performance

1. Using the Prodigy as a Simple Direct Box

Used this way, the Prodigy acts as an interface that lets you send the sound of your amp using the built-in Radial JDX™ balanced output to the PA or recording system. This takes advantage of the reactive load that captures both the sound of your amp head and the back-electromotive impulse from the loudspeaker. It has no audible effect to your amp sound.

- a. Connect the output from your amp to the Prodigy FROM AMP ¼” input
- b. Connect the 100% output from the Prodigy to your speaker cabinet
- c. Connect the XLR output from the Prodigy to the PA mixer or recording preamp
- d. Connect the power adaptor to the Prodigy to turn it on – there is no power switch
- e. Power up your amp and slowly increase the volume

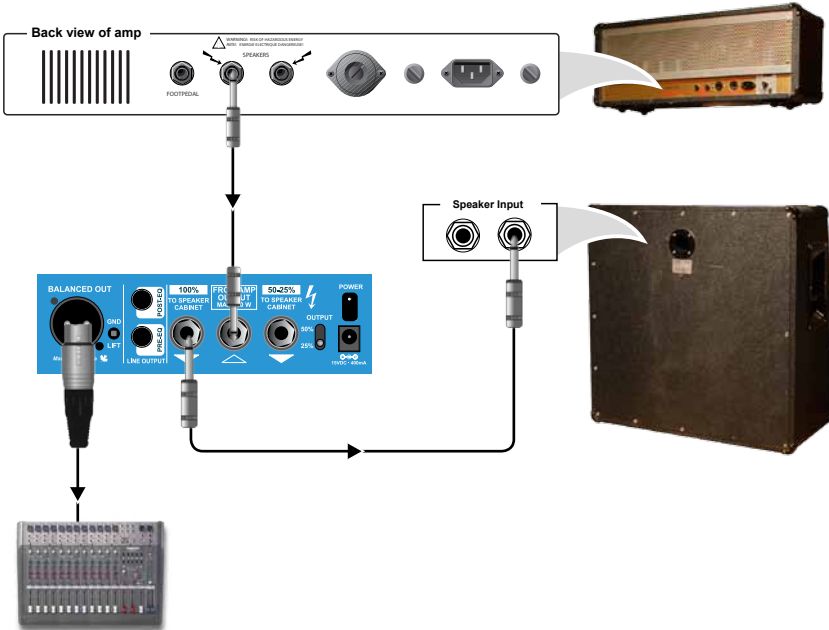

2. Using the Prodigy to send 50% or 25% of the amp output to the speaker cabinet

Here, the Prodigy reduces the output level on your amp. This lets you drive the power amp section of your amp harder to optimize the tone while lowering the volume level on stage or in the studio. Engineers will sometimes combine the JDX output with a mic in front of the cabinet and mix the two sounds.

- Connect the output from your amp to the Prodigy FROM AMP ¼" input
- Connect the 25%-50% output from the Prodigy to your speaker cabinet
- Set the output switch to either 25% or 50%
- Connect the XLR output from the Prodigy to the PA mixer or recording preamp
- Connect the power adaptor to the Prodigy to turn it on – there is no power switch
- Power up your amp and slowly increase the volume

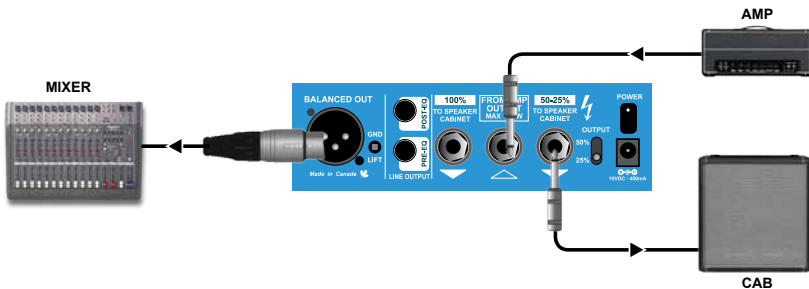

3. Using the Headload Prodigy to silence your amp

This setting turns off your guitar amp's speaker cabinet completely for silent performance. This works great for gigs where you do not want to haul a speaker cabinet to the show or for quiet late-night recording in the studio. This takes full advantage of the built-in JDX speaker simulator to capture your amplifier's tone and the load box to keep your amp safe and quiet.

- Connect the output from your amp to the Prodigy FROM AMP ¼" input
- Do not connect the output from the Prodigy to your speaker cabinet
- Connect the XLR output from the Prodigy to the PA mixer or recording preamp
- Connect the power adaptor to the Prodigy to turn it on – there is no power switch
- Power up your amp and slowly increase the volume

When testing, it is good practice to keep the volume level down low to ensure proper connections have been made before turning up. This can prevent connection spikes from damaging sensitive components.



THE JDX BALANCED OUTPUT

The Headload Prodigy's JDX balanced output is designed to simulate the sound of a 4 x 12 half stack. This lets you capture your sound 'direct' without having to use a microphone. The benefits to performing and recording this way are numerous. Moving a microphone ever so slightly will change the sound, so getting it exactly the same every night or for every session is practically impossible. Further, each time you change venues, resonant frequencies caused by the stage and room acoustics vary, which means that EQ'ing the tone to get it right has to be redone every show. Finally, noise pollution from the other instruments on stage, such as bass or drums, entering the mic makes it difficult to solo the instrument. With the Prodigy direct out, all of these problems simply go away. You get consistency night after night, gig after gig, and from one recording to the next.

The JDX output is set to mic level in order to match up with other mics on stage. This makes it possible to feed a traditional snake or mic splitter, which in turn can feed the PA, wedge monitors and in-ear monitors.

In the studio you can record as usual with a mic and record a second channel using the JDX output. This lets you compare or combine the two signals to create richer and more consistent tones. You can take things further by introducing a Radial Phazer™ into the equation by phase correcting the direct JDX signal so that it is time-aligned with the mic. The Prodigy is a creative tool that should be used to experiment.

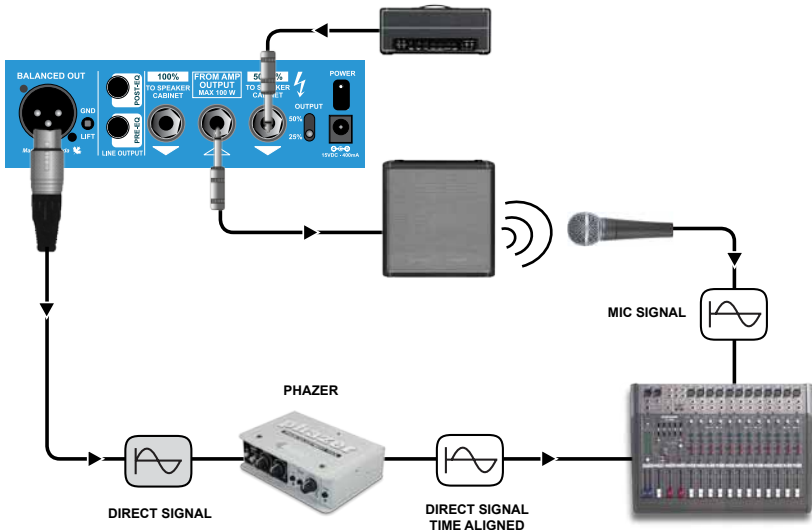

USING THE JDX AUX OUTPUTS

There are two additional ¼" unbalanced outputs on the rear panel. These provide connectivity options that can open the door to new sounds or creative ideas. A dedicated front panel level control lets you adjust the signal for both outputs to suit.

- **Dry Output (pre-JDX)**
This takes the original 'dry' sound from your guitar amp head and attenuates it so that it can be used to drive another guitar amp, digital modeling device, effects pedals, or maybe a JDI direct box so that you can then process the sound in your digital workstation or reamp it in the future.
- **Wet Output (post-JDX)**
This parallel output produces the same processed or 'wet' signal as the JDX – only here it is unbalanced. This means that the front panel EQ will also affect this output. It can be used to feed effects pedals, digital modeler or maybe some other innovative studio device.

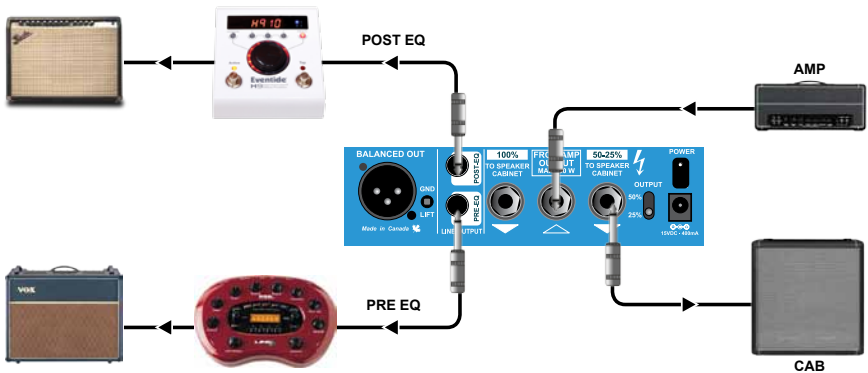

USING THE PRODIGY FEATURES

Adjusting the Tone Using the 2-band EQ

The Prodigy is equipped with a two band equalizer that lets you fine tune the tone of the JDx output. It has no effect on the amplifier's speaker signal. Used live, this lets you adjust the tone of the wedge monitors on in-ears to suit. In the studio, it lets you quickly tailor the tone as needed. Start with the EQ settings at 12 o'clock and adjust as you see fit.

Frequency response with flat EQ settings

Frequency response of EQ range

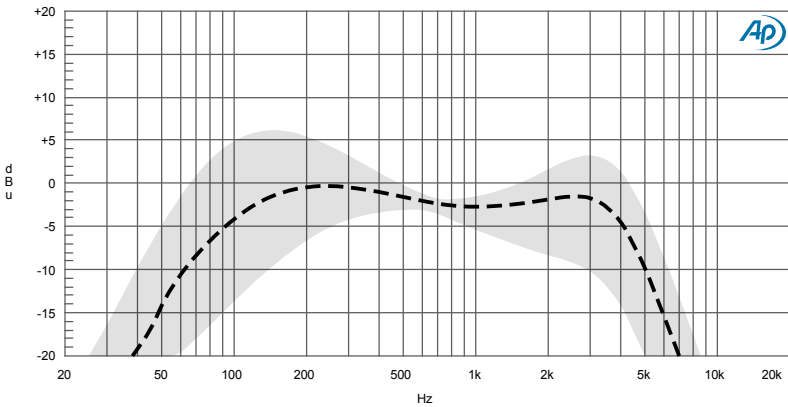

Using Headphones

Finally, one of the coolest features on the Prodigy is the headphone out which will work with most headphones from 8 Ohms to 400 Ohms and lets you quietly practice using your amp to create the signal. It is equipped with a dedicated level control and a 1/4" TRS connection. Note that the headphone output is mono.

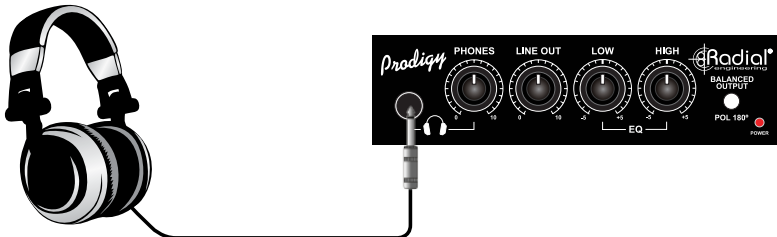

The 180° Polarity Reverse Switch

The Headload Prodigy's JDX output is wired to the AES standard with pin-1 (ground), pin-2 (+), and pin-3 (-). This follows convention with all pro audio gear made in recent years. But when combining the JDX with older vintage gear, you may find that the input on your vintage processor may have the polarity reversed. To address this, the Prodigy is equipped with a 180° polarity reverse switch that toggles pin-2 and pin-3 at the XLR output, inverting the relative phase.

The polarity reverse function can also be used to compensate for 'acoustic peaks and valleys' at certain spots on stage that can cause some frequencies to sound louder than others due the interaction of the amp, monitors and PA. Switching the polarity can sometimes help normalize the sound where you may be standing.

Finally, when recording, placing a mic in front of the cabinet and then further away will change the tone depending on room acoustics and the effects of comb-filtering. Combining the mic'd sound with the Prodigy's JDX direct output can lead to great results. Try reversing the polarity to improve the phase relationship between the two signals and then, for fun, try moving the distant mic around. Simply find the setting that sounds best to your ears.

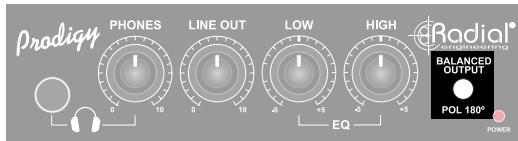

Using the Ground Lift

A common problem in both studios and live PA is the hum and buzz that seems to propagate as soon as various pieces of audio devices are connected together. This problem is often referred to as a ground loop. In general terms, when plugged in to the electrical system, for safety, all of the devices share the same electrical ground. When an audio connection is made, the audio ground creates a loop that allows noise from spurious DC currents and other 'gremlins' to pollute the audio signal.

To help eliminate the hum and buzz caused by ground loops, the Headload Prodigy is equipped with a ground lift switch that lifts pin-1 on the XLR output. If you hear hum, push the switch inward. The switch is recessed in order to prevent accidental use. To switch, use a small screwdriver.

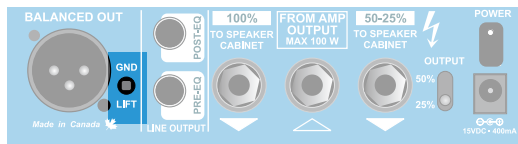

RACK MOUNTING THE PRODIGY

For touring, the Prodigy may be mounted into a standard 19" rack using the optional rack mount kit. This three piece kit (*part number: R800 2020 02*) enables one or two Prodigy to be rack mounted in a 1RU rack space. We recommend leaving one rack space open above the Prodigy to allow air flow.

Single unit mounting:

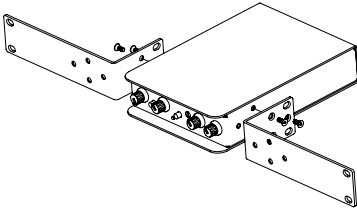

Double unit mounting:

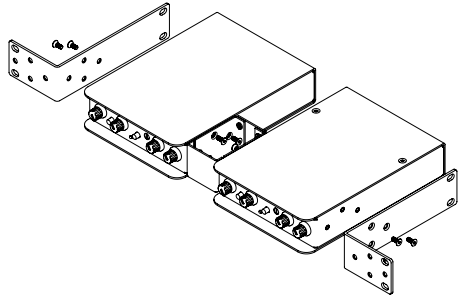

CONNECTING THE AMPLIFIER AND SPEAKER

You can connect amplifiers up to 120 Watts RMS (180W peak) to the Prodigy and drive them at full power. We recommend using speaker cables eight feet or less in length with a minimum gauge of 1.5mm² (14 awg). Longer speaker cables should use heavier gauges to maintain the best power transfer. Use the chart below as a guide when selecting speaker cables to use with your Prodigy.

Cable Length	100 Watt Amp 8 Ohms	100 Watt Amp 4 Ohms	50 Watt Amp 8 Ohms	50 Watt Amp 4 Ohms
1.2 meters (4')	1.0mm ² (16 awg)	1.0mm ² (16 awg)	1.0mm ² (16 awg)	1.0mm ² (16 awg)
2.4 meters (8')	1.5mm ² (14 awg)	1.5mm ² (14 awg)	1.0mm ² (16 awg)	1.5mm ² (14 awg)
3 meters (10')	1.5mm ² (14 awg)	2.5mm ² (12 awg)	1.5mm ² (14 awg)	1.5mm ² (14 awg)
3.7 meters (12')	2.5mm ² (12 awg)	2.5mm ² (12 awg)	1.5mm ² (14 awg)	2.5mm ² (12 awg)
4.9 meters (16')	2.5mm ² (12 awg)	4.0mm ² (10 awg)	1.5mm ² (14 awg)	2.5mm ² (12 awg)
5.5 meters (18')	4.0mm ² (10 awg)	Do not use	2.5mm ² (12 awg)	2.5mm ² (12 awg)
6.0 meters (20')	Do not use	Do not use	2.5mm ² (12 awg)	2.5mm ² (12 awg)

BLOCK DIAGRAM

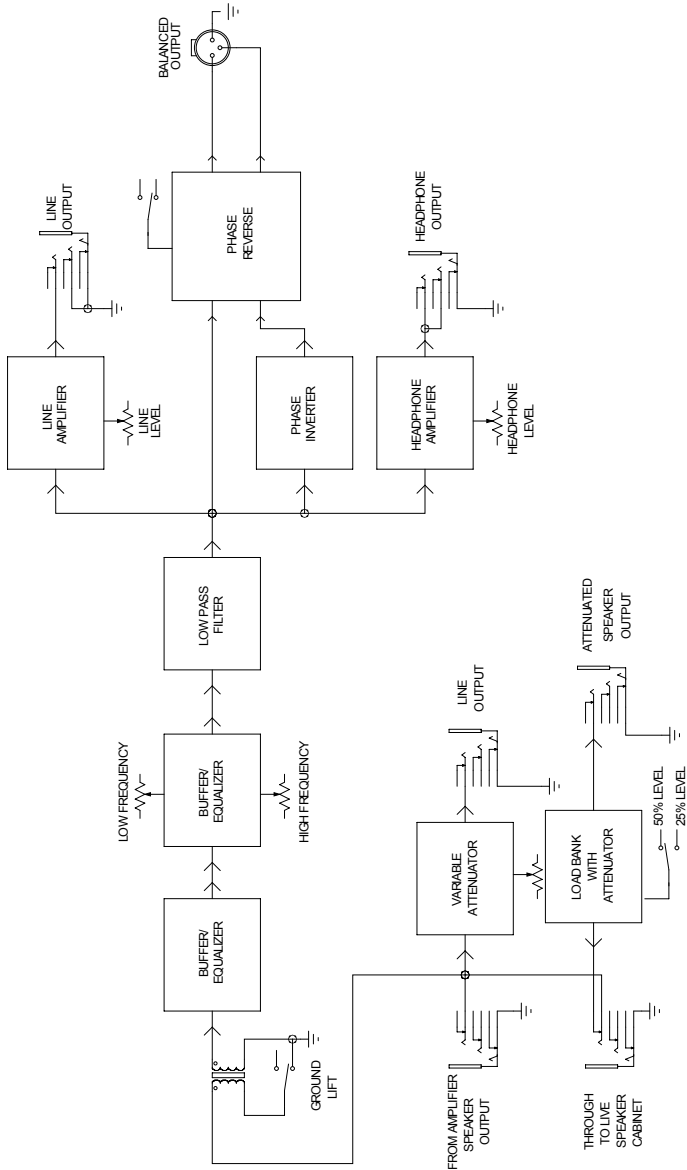

*Specifications are subject to change without notice.

OUTPUT SIGNAL FLOW

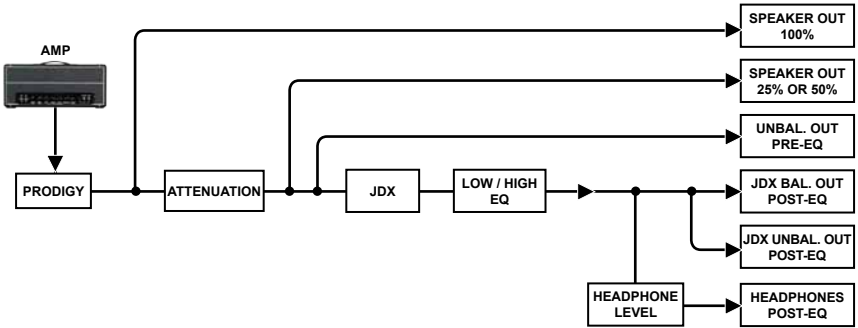

SPECIFICATIONS

- Audio Circuit Type: Passive attenuation circuit with active equalization
- Frequency response: Shaped to emulate a classic guitar cabinet
- Gain: -30dB/-42dB
- Noise floor: -106dBu
- Maximum input: 130 watts continuous
- Total harmonic distortion: 0.05%
- Intermodulation distortion: 0.05%
- Input / output impedance: 8Ω speaker load
- Output level - max - 1KHz: +17dBu
- Output level - max - 20Hz: +14dBu
- Size (W, D, H) & weight: 6" x 10.25" x 3.75"
- 152mm x 260mm x 95mm
- Weight: 5.3lbs. (2.4kg)
- Power supply: +/-15v (400mA) power supply

**Specifications are subject to change without notice.*

THREE YEAR TRANSFERABLE LIMITED WARRANTY

RADIAL ENGINEERING LTD. ("Radial") warrants this product to be free from defects in material and workmanship and will remedy any such defects free of charge according to the terms of this warranty. Radial will repair or replace (at its option) any defective component(s) of this product (excluding finish and wear and tear on components under normal use) for a period of three (3) years from the original date of purchase. In the event that a particular product is no longer available, Radial reserves the right to replace the product with a similar product of equal or greater value. In the unlikely event that a defect is uncovered, please call 604-942-1001 or email service@radialeng.com to obtain an RA number (Return Authorization number) before the 3 year warranty period expires. The product must be returned prepaid in the original shipping container (or equivalent) to Radial or to an authorized Radial repair center and you must assume the risk of loss or damage. A copy of the original invoice showing date of purchase and the dealer name must accompany any request for work to be performed under this limited and transferable warranty. This warranty shall not apply if the product has been damaged due to abuse, misuse, misapplication, accident or as a result of service or modification by any other than an authorized Radial repair center.

THERE ARE NO EXPRESSED WARRANTIES OTHER THAN THOSE ON THE FACE HEREOF AND DESCRIBED ABOVE. NO WARRANTIES WHETHER EXPRESSED OR IMPLIED, INCLUDING BUT NOT LIMITED TO, ANY IMPLIED WARRANTIES OF MERCHANTABILITY OR FITNESS FOR A PARTICULAR PURPOSE SHALL EXTEND BEYOND THE RESPECTIVE WARRANTY PERIOD DESCRIBED ABOVE OF THREE YEARS. RADIAL SHALL NOT BE RESPONSIBLE OR LIABLE FOR ANY SPECIAL, INCIDENTAL OR CONSEQUENTIAL DAMAGES OR LOSS ARISING FROM THE USE OF THIS PRODUCT. THIS WARRANTY GIVES YOU SPECIFIC LEGAL RIGHTS, AND YOU MAY ALSO HAVE OTHER RIGHTS, WHICH MAY VARY DEPENDING ON WHERE YOU LIVE AND WHERE THE PRODUCT WAS PURCHASED.



www.radialeng.com

Radial Engineering Ltd.

1588 Kebet Way, Port Coquitlam BC V3C 5M5

tel: 604-942-1001 • fax: 604-942-1010

info@radialeng.com • www.radialeng.com

